

Ergebnis: **307.7** (295)  
 Serien: 103.2 101.6 102.9  
 Zähler: 25 5 0 0 0 0 0 0 0 0  
 Innenzehner: 16  
 Weitesten: 332 (12.), 279 (20.), 277 (28.)  
 beste Teiler: 45.5 (8.), 52.0 (27.), 73.7 (1.)  
 Trefferlage: 0.11 mm rechts, 0.43 mm tief  
 Streuwert: 1.32, horizontal: 1.57, vertikal: 1.02

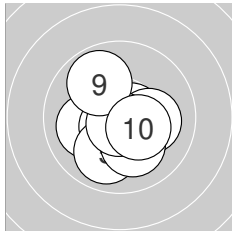
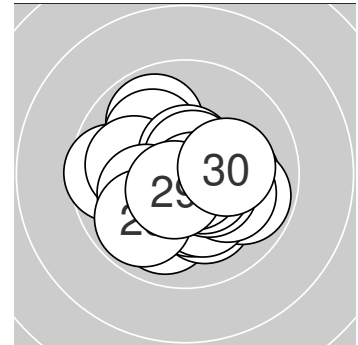

**Serie 1:**

10.7 *	10.1 ←	10.6 *	10.6 *	9.9 ↙
10.1 →	10.1 ↘	10.8 *	9.9 ↘	10.4 *

beste Teiler: 45.5 (8.), 73.7 (1.), 77.9 (4.)  
 Trefferlage: 0.05 mm rechts, 0.48 mm tief  
 Streuwert: 1.27, horizontal: 1.30, vertikal: 1.24

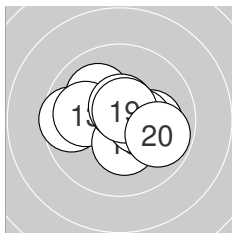

**Serie 2:**

10.1 ↘	9.6 ←	10.0 ←	10.1 →	10.3 *
10.6 *	10.1 →	10.4 *	10.6 *	9.8 →

beste Teiler: 76.4 (19.), 93.5 (16.), 136.2 (18.)  
 Trefferlage: 0.18 mm rechts, 0.04 mm hoch  
 Streuwert: 1.57, horizontal: 2.00, vertikal: 0.94

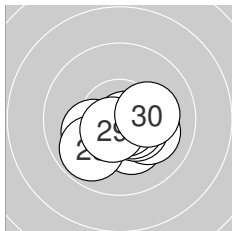

**Serie 3:**

10.2 *	10.1 →	10.4 *	10.6 *	10.1 ↙
10.2 *	10.7 *	9.8 ↙	10.6 *	10.2 *

beste Teiler: 52.0 (27.), 87.0 (29.), 97.2 (24.)  
 Trefferlage: 0.11 mm rechts, 0.85 mm tief  
 Streuwert: 1.16, horizontal: 1.50, vertikal: 0.66



Ergebnis: **310.3** (299)  
 Serien: 102.5 103.2 104.6  
 Zähler: 29 1 0 0 0 0 0 0 0  
 Innenzehner: 21  
 Weitesten: 272 (11.), 247 (1.), 236 (30.)  
 beste Teiler: 16.1 (29.), 30.4 (26.), 61.1 (28.)  
 Trefferlage: 0.18 mm links, 0.47 mm tief  
 Streuwert: 1.13, horizontal: 0.93, vertikal: 1.29

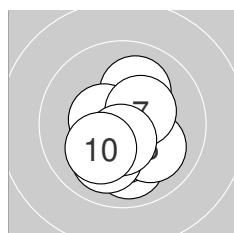
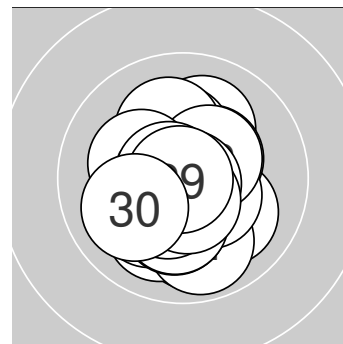

**Serie 1:**  
 10.0 ↓                      10.4 \*                      10.1 ↑                      10.5 \*                      10.3 \*  
 10.1 ↘                      10.4 \*                      10.0 ↙                      10.6 \*                      10.1 ↙  
 beste Teiler: 99.6 (9.), 119.5 (4.), 139.6 (7.)  
 Trefferlage: 0.03 mm links, 0.81 mm tief  
 Streuwert: 1.25, horizontal: 1.06, vertikal: 1.42

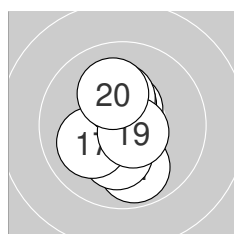

**Serie 2:**  
 9.9 ↓                      10.6 \*                      10.5 \*                      10.2 \*                      10.5 \*  
 10.4 \*                      10.1 ↙                      10.3 \*                      10.6 \*                      10.1 ↑  
 beste Teiler: 77.6 (12.), 79.3 (19.), 103.8 (15.)  
 Trefferlage: 0.20 mm links, 0.16 mm tief  
 Streuwert: 1.23, horizontal: 0.77, vertikal: 1.57

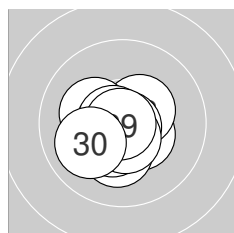

**Serie 3:**  
 10.4 \*                      10.4 \*                      10.2 \*                      10.2 \*                      10.4 \*  
 10.8 \*                      10.6 \*                      10.7 \*                      10.9 \*                      10.0 ↙  
 beste Teiler: 16.1 (29.), 30.4 (26.), 61.1 (28.)  
 Trefferlage: 0.29 mm links, 0.45 mm tief  
 Streuwert: 0.94, horizontal: 1.02, vertikal: 0.84



Ergebnis: **307.4** (295)  
 Serien: 101.0 104.2 102.2  
 Zähler: 25 5 0 0 0 0 0 0 0  
 Innenzehner: 21  
 Weitestе: 431 (8.), 332 (21.), 320 (25.)  
 beste Teiler: 44.6 (18.), 61.2 (17.), 68.6 (27.)  
 Trefferlage: 0.04 mm rechts, 0.38 mm tief  
 Streuwert: 1.40, horizontal: 1.70, vertikal: 1.01

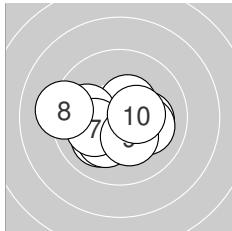
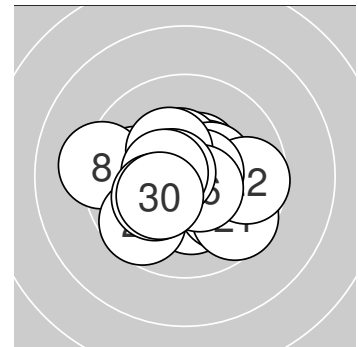

**Serie 1:**

10.1 ↙	10.5 *	9.9 ←	10.2 *	10.2 *
10.1 →	10.1 ←	9.2 ←	10.3 *	10.4 *

beste Teiler: 121.0 (2.), 131.8 (10.), 169.0 (9.)  
 Trefferlage: 0.46 mm links, 0.43 mm tief  
 Streuwert: 1.65, horizontal: 2.12, vertikal: 0.96

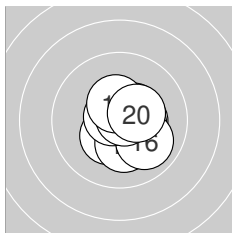

**Serie 2:**

10.5 *	10.4 *	10.4 *	10.4 *	10.2 *
10.0 ↘	10.7 *	10.8 *	10.4 *	10.4 *

beste Teiler: 44.6 (18.), 61.2 (17.), 122.1 (11.)  
 Trefferlage: 0.61 mm rechts, 0.18 mm tief  
 Streuwert: 0.98, horizontal: 0.95, vertikal: 1.01

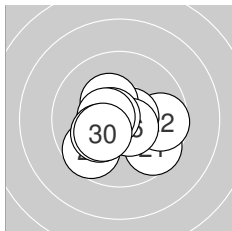

**Serie 3:**

9.6 ↘	9.7 →	10.6 *	10.3 *	9.7 ↙
10.6 *	10.7 *	10.5 *	10.2 *	10.3 *

beste Teiler: 68.6 (27.), 81.0 (23.), 98.0 (26.)  
 Trefferlage: 0.02 mm links, 0.55 mm tief  
 Streuwert: 1.49, horizontal: 1.79, vertikal: 1.12



**Ergebnis: 304.5 (292)**  
**Serien: 99.4 102.5 102.6**  
**Zähler: 22 8 0 0 0 0 0 0 0 0**  
**Innenzehner: 12**  
**Weiteste: 422 (3.), 319 (6.), 303 (13.)**  
**beste Teiler: 44.1 (29.), 78.5 (16.), 84.2 (8.)**  
**Trefferlage: 0.16 mm rechts, 0.19 mm tief**  
**Streuwert: 1.56, horizontal: 1.68, vertikal: 1.44**

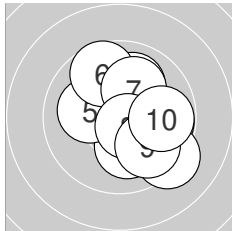
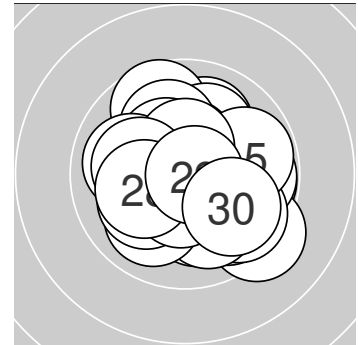

**Serie 1:**

10.0 ↗	9.8 →	9.3 ↘	10.1 ↓	10.1 ←
9.7 ↘	10.1 ↗	10.6 *	9.9 ↘	9.8 →

**beste Teiler: 84.2 (8.), 203.7 (4.), 208.5 (5.)**  
**Trefferlage: 1.06 mm rechts, 0.00 mm**  
**Streuwert: 1.83, horizontal: 1.74, vertikal: 1.91**

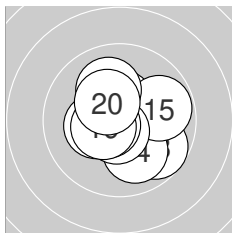

**Serie 2:**

10.5 *	10.3 *	9.7 ↘	10.0 ↓	9.8 →
10.6 *	10.1 ↘	10.6 *	10.5 *	10.4 *

**beste Teiler: 78.5 (16.), 87.8 (18.), 119.7 (19.)**  
**Trefferlage: 0.10 mm rechts, 0.04 mm tief**  
**Streuwert: 1.43, horizontal: 1.49, vertikal: 1.35**

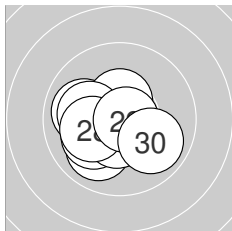

**Serie 3:**

10.0 ←	10.5 *	10.5 *	10.1 ←	10.0 ↘
10.1 ↘	10.5 *	10.2 *	10.8 *	9.9 ↘

**beste Teiler: 44.1 (29.), 102.1 (23.), 113.6 (27.)**  
**Trefferlage: 0.68 mm links, 0.53 mm tief**  
**Streuwert: 1.25, horizontal: 1.46, vertikal: 1.01**



**Ergebnis:** 312.2 (299)  
**Serien:** 102.9 104.7 104.6  
**Zähler:** 29 1 0 0 0 0 0 0 0  
**Innenzehner:** 25  
**Weiteste:** 251 (11.), 232 (9.), 218 (1.)  
**beste Teiler:** 32.5 (27.), 48.0 (12.), 50.9 (6.)  
**Trefferlage:** 0.21 mm rechts, 0.14 mm hoch  
**Streuwert:** 1.06, horizontal: 1.15, vertikal: 0.97

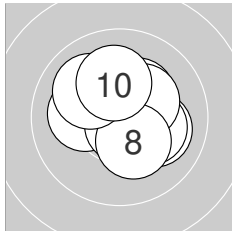
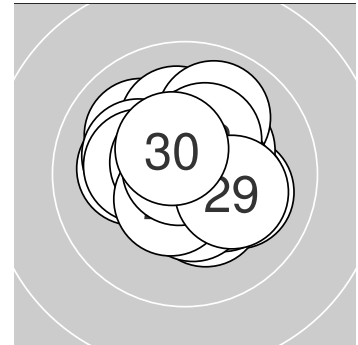

**Serie 1:**

10.1 ↗	10.7 *	10.2 *	10.1 ←	10.3 *
10.8 *	10.3 *	10.3 *	10.0 ↘	10.1 ↑

**beste Teiler:** 50.9 (6.), 73.0 (2.), 162.0 (7.)  
**Trefferlage:** 0.38 mm rechts, 0.28 mm hoch  
**Streuwert:** 1.26, horizontal: 1.39, vertikal: 1.12

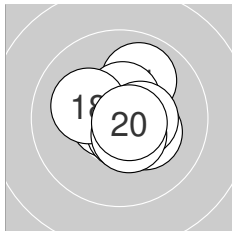

**Serie 2:**

9.9 ↗	10.8 *	10.3 *	10.7 *	10.5 *
10.5 *	10.6 *	10.2 *	10.5 *	10.7 *

**beste Teiler:** 48.0 (12.), 63.9 (20.), 70.5 (14.)  
**Trefferlage:** 0.24 mm rechts, 0.11 mm hoch  
**Streuwert:** 1.01, horizontal: 1.02, vertikal: 1.00

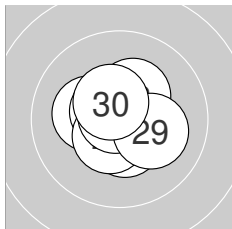

**Serie 3:**

10.7 *	10.5 *	10.2 *	10.6 *	10.3 *
10.5 *	10.8 *	10.3 *	10.2 *	10.5 *

**beste Teiler:** 32.5 (27.), 64.8 (21.), 86.2 (24.)  
**Trefferlage:** 0.02 mm rechts, 0.04 mm hoch  
**Streuwert:** 0.99, horizontal: 1.10, vertikal: 0.87



**Ergebnis:** **296.7** (282)  
**Serien:** 97.9 99.0 99.8  
**Zähler:** 13 16 1 0 0 0 0 0 0  
**Innenzehner:** 8  
**Weiteste:** 554 (14.), 454 (26.), 415 (21.)  
**beste Teiler:** 49.1 (24.), 56.6 (13.), 92.1 (18.)  
**Trefferlage:** 0.22 mm links, 0.32 mm hoch  
**Streuwert:** 2.07, horizontal: 2.28, vertikal: 1.85

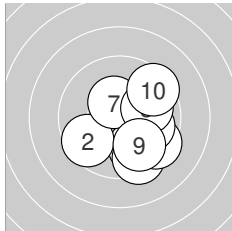
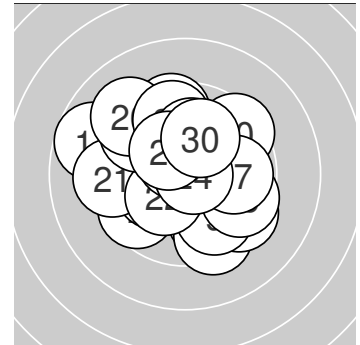

**Serie 1:**

9.8 ↘	9.6 ↙	9.4 ↘	9.4 ↘	10.1 →
9.9 →	10.4 *	10.0 →	9.8 ↘	9.5 ↗

**beste Teiler:** 136.7 (7.), 218.0 (5.), 246.9 (8.)  
**Trefferlage:** 1.43 mm rechts, 0.89 mm tief  
**Streuwert:** 1.86, horizontal: 1.78, vertikal: 1.93

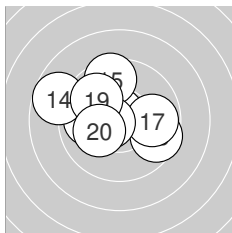

**Serie 2:**

10.1 ←	9.9 ←	10.7 *	8.7 ↖	9.5 ↑
9.6 →	9.8 →	10.6 *	9.9 ↘	10.2 *

**beste Teiler:** 56.6 (13.), 92.1 (18.), 195.4 (20.)  
**Trefferlage:** 0.96 mm links, 0.52 mm hoch  
**Streuwert:** 2.04, horizontal: 2.48, vertikal: 1.46

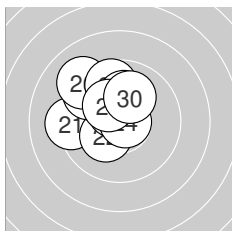

**Serie 3:**

9.3 ←	10.3 *	10.6 *	10.8 *	9.5 ↘
9.1 ↘	9.7 ↑	10.1 ↑	10.3 *	10.1 ↑

**beste Teiler:** 49.1 (24.), 96.8 (23.), 163.6 (29.)  
**Trefferlage:** 1.15 mm links, 1.35 mm hoch  
**Streuwert:** 1.58, horizontal: 1.66, vertikal: 1.50



**Ergebnis:** **299.7** (287)  
**Serien:** 98.7 100.4 100.6  
**Zähler:** 20 7 3 0 0 0 0 0 0 0  
**Innenzehner:** 16  
**Weiteste:** 549 (3.), 536 (25.), 535 (15.)  
**beste Teiler:** 77.2 (17.), 82.0 (12.), 89.4 (6.)  
**Trefferlage:** 0.09 mm rechts, 0.56 mm tief  
**Streuwert:** 1.98, horizontal: 2.21, vertikal: 1.71

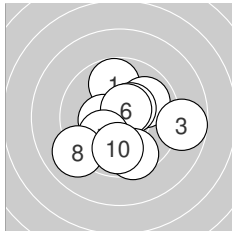
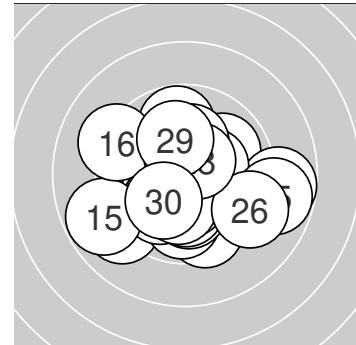

**Serie 1:**

9.8 ↑	9.9 ↗	8.8 →	10.5 *	10.4 *
10.6 *	10.1 ↘	9.1 ↙	9.6 ↓	9.9 ↓

**beste Teiler:** 89.4 (6.), 123.6 (4.), 142.0 (5.)  
**Trefferlage:** 0.32 mm rechts, 0.57 mm tief  
**Streuwert:** 2.26, horizontal: 2.45, vertikal: 2.05

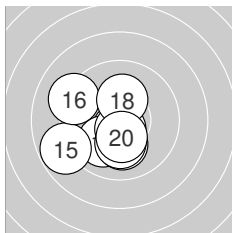

**Serie 2:**

10.3 *	10.6 *	10.0 ↙	10.1 ↓	8.8 ↙
9.2 ↖	10.6 *	10.2 *	10.2 *	10.4 *

**beste Teiler:** 77.2 (17.), 82.0 (12.), 148.0 (20.)  
**Trefferlage:** 0.98 mm links, 0.95 mm tief  
**Streuwert:** 1.72, horizontal: 1.86, vertikal: 1.56

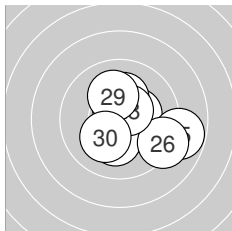

**Serie 3:**

10.6 *	10.3 *	10.5 *	10.2 *	8.8 →
9.2 ↘	10.2 *	10.5 *	10.1 ↑	10.2 *

**beste Teiler:** 96.0 (21.), 106.8 (28.), 113.2 (23.)  
**Trefferlage:** 0.95 mm rechts, 0.17 mm tief  
**Streuwert:** 1.82, horizontal: 2.04, vertikal: 1.57



**Ergebnis:** **296.0** (282)  
**Serien:** 99.1 98.1 98.8  
**Zähler:** 14 14 2 0 0 0 0 0 0 0  
**Innenzehner:** 7  
**Weiteste:** 524 (3.), 503 (24.), 498 (5.)  
**beste Teiler:** 71.8 (26.), 76.4 (10.), 99.4 (22.)  
**Trefferlage:** 0.94 mm rechts, 0.51 mm tief  
**Streuwert:** 2.02, horizontal: 2.51, vertikal: 1.36

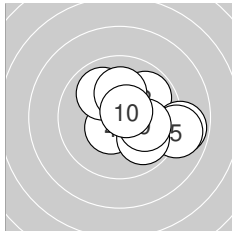
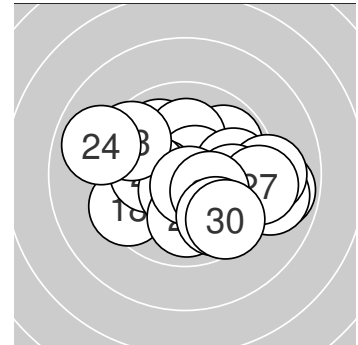

**Serie 1:**

10.1 →	9.9 ↗	8.9 →	10.5 *	9.0 →
9.9 ↘	10.0 ↖	10.1 ↑	10.1 →	10.6 *

**beste Teiler:** 76.4 (10.), 115.1 (4.), 205.1 (8.)  
**Trefferlage:** 1.70 mm rechts, 0.08 mm hoch  
**Streuwert:** 1.83, horizontal: 2.17, vertikal: 1.41

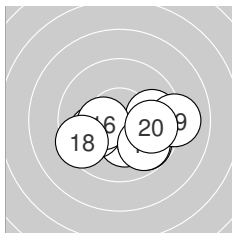

**Serie 2:**

9.8 ↘	10.2 *	9.6 →	10.0 ←	9.8 →
10.4 *	9.8 ↘	9.5 ←	9.1 →	9.9 →

**beste Teiler:** 142.5 (16.), 179.4 (12.), 229.9 (14.)  
**Trefferlage:** 1.14 mm rechts, 0.91 mm tief  
**Streuwert:** 1.95, horizontal: 2.59, vertikal: 0.93

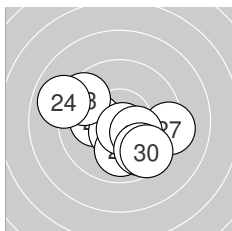

**Serie 3:**

10.1 ←	10.6 *	9.5 ↖	8.9 ←	10.0 ↓
10.7 *	9.3 →	10.3 *	9.8 ↘	9.6 ↘

**beste Teiler:** 71.8 (26.), 99.4 (22.), 169.7 (28.)  
**Trefferlage:** 0.02 mm links, 0.69 mm tief  
**Streuwert:** 2.19, horizontal: 2.67, vertikal: 1.58





Ergebnis: **309.1** (297)  
 Serien: 102.9 103.5 102.7  
 Zähler: 27 3 0 0 0 0 0 0 0 0  
 Innenzehner: 21  
 Weitestе: 324 (6.), 269 (18.), 251 (24.)  
 beste Teiler: 53.4 (25.), 60.0 (5.), 76.8 (30.)  
 Trefferlage: 0.04 mm rechts, 0.53 mm tief  
 Streuwert: 1.22, horizontal: 1.34, vertikal: 1.10

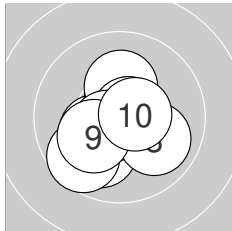
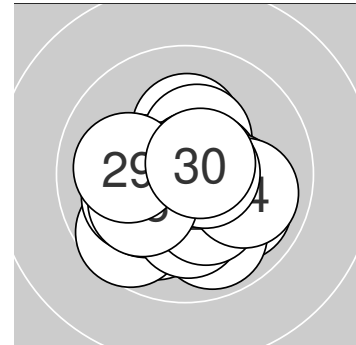

**Serie 1:**

10.3 *	10.6 *	10.0 ↙	10.2 *	10.7 *
9.7 ↘	10.6 *	10.0 ↘	10.2 *	10.6 *

beste Teiler: 60.0 (5.), 89.2 (2.), 96.6 (10.)  
 Trefferlage: 0.34 mm links, 0.51 mm tief  
 Streuwert: 1.33, horizontal: 1.33, vertikal: 1.32

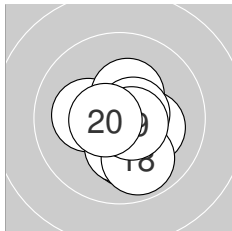

**Serie 2:**

10.6 *	10.2 *	10.1 ↓	10.2 *	10.4 *
10.3 *	10.6 *	9.9 ↓	10.6 *	10.6 *

beste Teiler: 79.7 (19.), 86.1 (11.), 87.2 (17.)  
 Trefferlage: 0.35 mm rechts, 0.50 mm tief  
 Streuwert: 1.13, horizontal: 1.05, vertikal: 1.20

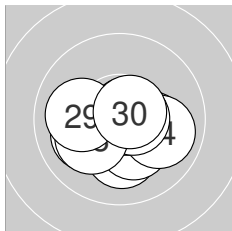

**Serie 3:**

10.2 *	10.2 *	10.3 *	9.9 ↘	10.7 *
10.1 ↙	10.6 *	10.1 ↙	10.0 ←	10.6 *

beste Teiler: 53.4 (25.), 76.8 (30.), 82.0 (27.)  
 Trefferlage: 0.11 mm rechts, 0.57 mm tief  
 Streuwert: 1.28, horizontal: 1.61, vertikal: 0.83



**Ergebnis:** **306.7** (296)  
**Serien:** 102.3 101.4 103.0  
**Zähler:** 26 4 0 0 0 0 0 0 0 0  
**Innenzehner:** 20  
**Weiteste:** 322 (11.), 308 (8.), 258 (15.)  
**beste Teiler:** 25.8 (21.), 52.4 (6.), 95.4 (10.)  
**Trefferlage:** 0.05 mm rechts, 0.25 mm tief  
**Streuwert:** 1.39, horizontal: 1.66, vertikal: 1.05

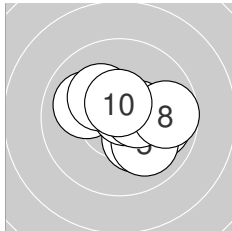
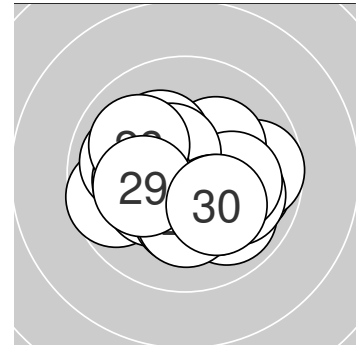

**Serie 1:**

10.0 ↖	10.2 *	10.5 *	9.9 →	10.0 ↘
10.7 *	10.5 *	9.7 →	10.2 *	10.6 *

**beste Teiler:** 52.4 (6.), 95.4 (10.), 104.3 (3.)  
**Trefferlage:** 0.74 mm rechts, 0.04 mm hoch  
**Streuwert:** 1.33, horizontal: 1.61, vertikal: 0.98

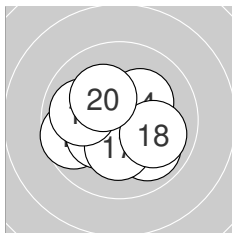

**Serie 2:**

9.7 ↙	10.4 *	10.5 *	10.2 *	9.9 ↘
10.3 *	10.2 *	10.0 ↘	10.0 ↖	10.2 *

**beste Teiler:** 106.4 (13.), 145.0 (12.), 167.4 (16.)  
**Trefferlage:** 0.29 mm links, 0.48 mm tief  
**Streuwert:** 1.53, horizontal: 1.82, vertikal: 1.16

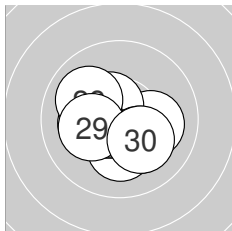

**Serie 3:**

10.9 *	10.5 *	10.1 →	10.5 *	10.2 *
10.2 *	10.2 *	10.0 ↖	10.2 *	10.2 *

**beste Teiler:** 25.8 (21.), 111.2 (24.), 114.5 (22.)  
**Trefferlage:** 0.28 mm links, 0.32 mm tief  
**Streuwert:** 1.28, horizontal: 1.49, vertikal: 1.03



**Ergebnis: 295.3 (281)**  
**Serien: 98.7 95.9 100.7**  
**Zähler: 15 12 2 1 0 0 0 0 0 0**  
**Innenzehner: 11**  
**Weiteste: 763 (13.), 561 (2.), 507 (17.)**  
**beste Teiler: 67.4 (8.), 68.7 (28.), 88.5 (10.)**  
**Trefferlage: 0.44 mm links, 1.17 mm tief**  
**Streuwert: 2.10, horizontal: 2.48, vertikal: 1.63**

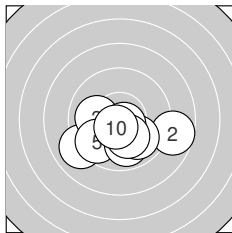
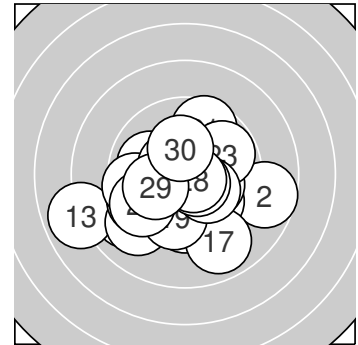

**Serie 1:**

9.0 ↙                      8.7 →                      10.0 ←  
 9.9 ↓                      9.9 ↓                      10.7 \*

**beste Teiler: 67.4 (8.), 88.5 (10.), 193.6 (9.)**  
**Trefferlage: 0.18 mm rechts, 1.55 mm tief**  
**Streuwert: 1.98, horizontal: 2.64, vertikal: 0.94**

10.0 ↘                      9.7 ↙  
 10.2 \*                      10.6 \*

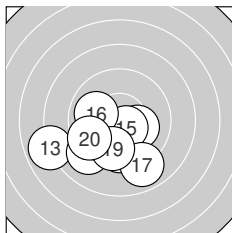

**Serie 2:**

9.7 ↓                      10.3 \*                      7.9 ↙  
 10.0 ↖                      8.9 ↓                      9.1 ↙

**beste Teiler: 101.4 (15.), 153.8 (12.), 195.3 (14.)**  
**Trefferlage: 1.24 mm links, 2.06 mm tief**  
**Streuwert: 2.26, horizontal: 2.79, vertikal: 1.55**

10.2 \*                      10.5 \*  
 9.8 ↓                      9.5 ↙

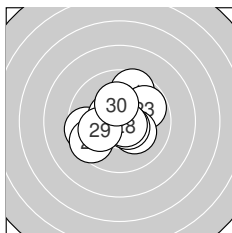

**Serie 3:**

9.6 ↗                      9.6 ←                      9.8 ↗  
 10.5 \*                      9.5 ↙                      10.7 \*

**beste Teiler: 68.7 (28.), 105.0 (25.), 113.0 (26.)**  
**Trefferlage: 0.27 mm links, 0.10 mm hoch**  
**Streuwert: 1.79, horizontal: 1.99, vertikal: 1.56**

10.2 \*                      10.5 \*  
 10.1 ↖                      10.2 \*



Ergebnis: **304.7** (292)  
 Serien: 102.9 101.3 100.5  
 Zähler: 22 8 0 0 0 0 0 0 0 0  
 Innenzehner: 16  
 Weitesten: 398 (28.), 354 (18.), 354 (23.)  
 beste Teiler: 29.7 (8.), 86.0 (19.), 89.8 (21.)  
 Trefferlage: 0.62 mm links, 0.80 mm tief  
 Streuwert: 1.38, horizontal: 1.42, vertikal: 1.33

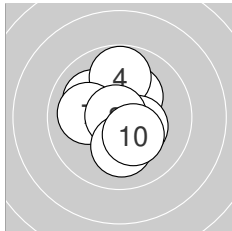
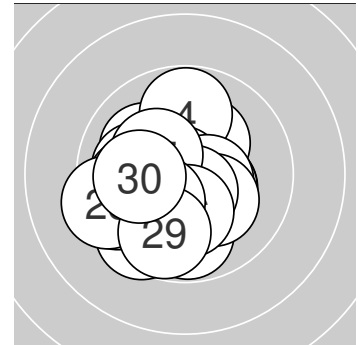

**Serie 1:**

10.1 ↘	10.6 *	10.2 *	9.8 ↑	10.4 *
10.6 *	10.0 ←	10.8 *	10.1 ↓	10.3 *

beste Teiler: 29.7 (8.), 90.6 (6.), 97.9 (2.)  
 Trefferlage: 0.20 mm links, 0.15 mm hoch  
 Streuwert: 1.34, horizontal: 1.19, vertikal: 1.47

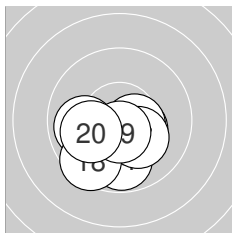

**Serie 2:**

10.4 *	10.4 *	9.9 ↓	9.8 ↓	10.5 *
9.9 ←	10.2 *	9.5 ↙	10.6 *	10.1 ←

beste Teiler: 86.0 (19.), 113.2 (15.), 140.4 (12.)  
 Trefferlage: 0.26 mm links, 1.36 mm tief  
 Streuwert: 1.28, horizontal: 1.52, vertikal: 0.99

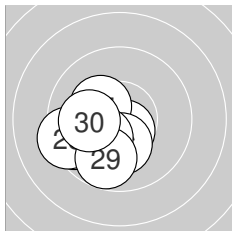

**Serie 3:**

10.6 *	10.3 *	9.5 ←	10.1 ↓	10.3 *
10.2 *	10.2 *	9.4 ←	9.8 ↓	10.1 ←

beste Teiler: 89.8 (21.), 157.2 (22.), 166.4 (25.)  
 Trefferlage: 1.40 mm links, 1.19 mm tief  
 Streuwert: 1.18, horizontal: 1.32, vertikal: 1.03



**Ergebnis:** **307.8** (295)  
**Serien:** 103.8 103.3 100.7  
**Zähler:** 25 5 0 0 0 0 0 0 0 0  
**Innenzehner:** 22  
**Weiteste:** 437 (23.), 367 (29.), 343 (6.)  
**beste Teiler:** 7.2 (2.), 71.3 (12.), 73.3 (20.)  
**Trefferlage:** 0.49 mm links, 0.19 mm tief  
**Streuwert:** 1.36, horizontal: 1.61, vertikal: 1.05

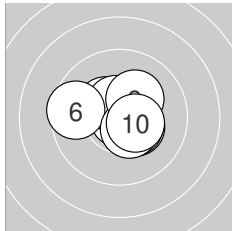
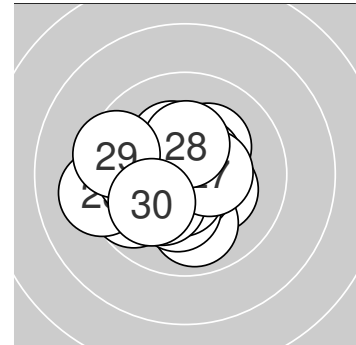

**Serie 1:**

10.4 *	10.9 *	10.5 *	10.5 *	10.4 *
9.6 ←	10.4 *	10.5 *	10.2 *	10.4 *

**beste Teiler:** 7.2 (2.), 102.7 (4.), 113.7 (3.)  
**Trefferlage:** 0.16 mm rechts, 0.15 mm hoch  
**Streuwert:** 1.20, horizontal: 1.48, vertikal: 0.84

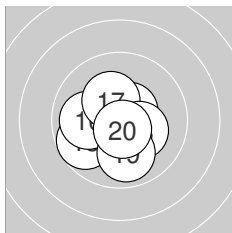

**Serie 2:**

10.6 *	10.7 *	9.7 ↙	10.6 *	10.5 *
10.0 ←	10.3 *	10.3 *	9.9 ↓	10.7 *

**beste Teiler:** 71.3 (12.), 73.3 (20.), 80.0 (11.)  
**Trefferlage:** 0.23 mm links, 0.30 mm tief  
**Streuwert:** 1.29, horizontal: 1.37, vertikal: 1.21

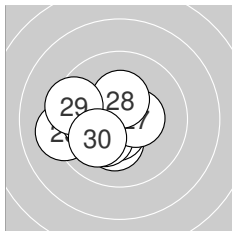

**Serie 3:**

10.2 *	10.6 *	9.2 ←	10.2 *	10.0 ←
10.2 *	10.4 *	10.3 *	9.5 ←	10.1 ↙

**beste Teiler:** 99.6 (22.), 126.1 (27.), 153.1 (28.)  
**Trefferlage:** 1.40 mm links, 0.44 mm tief  
**Streuwert:** 1.42, horizontal: 1.68, vertikal: 1.09



**Ergebnis:** **307.3** (295)  
**Serien:** 101.7 102.6 103.0  
**Zähler:** 25 5 0 0 0 0 0 0 0 0  
**Innenzehner:** 17  
**Weiteste:** 334 (18.), 278 (5.), 278 (26.)  
**beste Teiler:** 39.0 (20.), 74.4 (14.), 93.0 (11.)  
**Trefferlage:** 0.27 mm rechts, 0.16 mm hoch  
**Streuwert:** 1.35, horizontal: 1.40, vertikal: 1.31

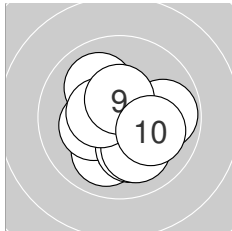
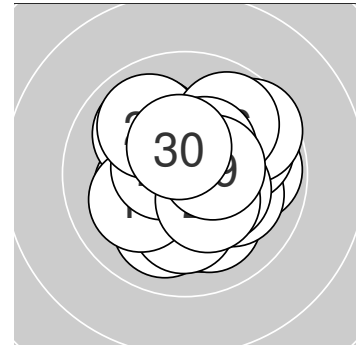

**Serie 1:**

10.3 *	10.0 ↙	10.3 *	10.1 ↓	9.8 →
10.1 ↘	10.0 ↘	10.5 *	10.5 *	10.1 →

**beste Teiler:** 115.0 (9.), 123.4 (8.), 158.4 (1.)  
**Trefferlage:** 0.25 mm rechts, 0.50 mm tief  
**Streuwert:** 1.45, horizontal: 1.51, vertikal: 1.38

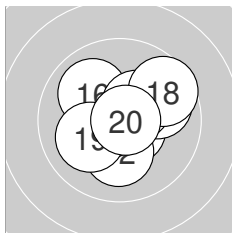

**Serie 2:**

10.6 *	10.1 ↓	10.4 *	10.7 *	9.9 →
10.0 ↘	10.4 *	9.6 ↗	10.1 ↙	10.8 *

**beste Teiler:** 39.0 (20.), 74.4 (14.), 93.0 (11.)  
**Trefferlage:** 0.18 mm rechts, 0.22 mm hoch  
**Streuwert:** 1.44, horizontal: 1.62, vertikal: 1.24

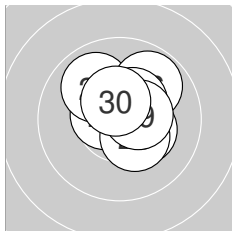

**Serie 3:**

10.3 *	10.4 *	10.6 *	10.2 *	9.9 ↘
9.8 ↗	10.4 *	10.4 *	10.5 *	10.5 *

**beste Teiler:** 97.4 (23.), 118.6 (30.), 122.4 (29.)  
**Trefferlage:** 0.37 mm rechts, 0.78 mm hoch  
**Streuwert:** 1.12, horizontal: 1.17, vertikal: 1.08



**Ergebnis: 305.4 (290)**  
**Serien: 102.7 101.3 101.4**  
**Zähler: 20 10 0 0 0 0 0 0 0 0**  
**Innenzehner: 18**  
**Weiteste: 435 (23.), 403 (24.), 364 (4.)**  
**beste Teiler: 17.4 (22.), 33.6 (25.), 49.0 (28.)**  
**Trefferlage: 0.13 mm rechts, 0.30 mm tief**  
**Streuwert: 1.57, horizontal: 1.48, vertikal: 1.66**

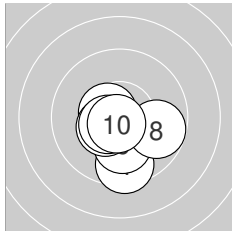
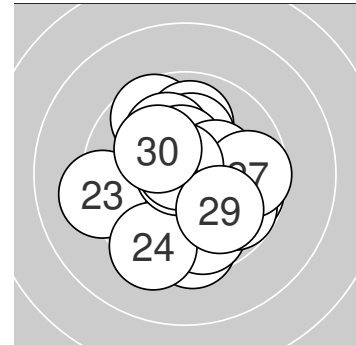

**Serie 1:**

10.3 *	10.2 *	10.6 *	9.5 ↓	10.6 *
10.1 ↓	10.4 *	9.8 ↘	10.5 *	10.7 *

**beste Teiler: 55.4 (10.), 78.1 (5.), 99.5 (3.)**  
**Trefferlage: 0.10 mm rechts, 1.18 mm tief**  
**Streuwert: 1.13, horizontal: 1.17, vertikal: 1.09**

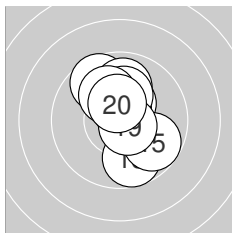

**Serie 2:**

10.4 *	9.6 ↖	9.7 ↓	9.9 ↑	9.8 ↘
10.6 *	10.2 *	10.1 ↖	10.6 *	10.4 *

**beste Teiler: 77.4 (19.), 84.4 (16.), 130.3 (20.)**  
**Trefferlage: 0.27 mm rechts, 0.76 mm hoch**  
**Streuwert: 1.53, horizontal: 1.08, vertikal: 1.87**

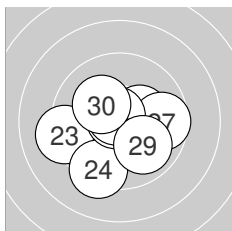

**Serie 3:**

10.3 *	10.9 *	9.2 ←	9.3 ↓	10.8 *
10.3 *	9.7 →	10.8 *	9.9 ↘	10.2 *

**beste Teiler: 17.4 (22.), 33.6 (25.), 49.0 (28.)**  
**Trefferlage: 0.03 mm rechts, 0.50 mm tief**  
**Streuwert: 1.81, horizontal: 2.13, vertikal: 1.42**



Ergebnis: **298.1** (284)  
 Serien: 100.4 96.0 101.7  
 Zähler: 19 8 1 2 0 0 0 0 0 0  
 Innenzehner: 12  
 Weitester: 2526 (2.), 2459 (13.), 1923 (12.)  
 beste Teiler: 185.0 (5.), 257.5 (1.), 281.8 (3.)  
 Trefferlage: 2.32 mm links, 0.18 mm tief  
 Streuwert: 7.05, horizontal: 2.21, vertikal: 9.72

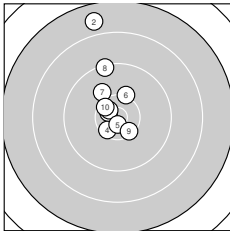
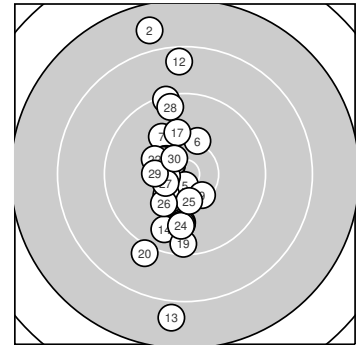

**Serie 1:**

10.6 *	7.8 ↑	10.6 *	10.4 *	10.7 *
10.2 ↗	10.0 ↘	9.3 ↑	10.4 *	10.4 *

beste Teiler: 185.0 (5.), 257.5 (1.), 281.8 (3.)  
 Trefferlage: 1.84 mm links, 4.61 mm hoch  
 Streuwert: 6.37, horizontal: 2.76, vertikal: 8.57

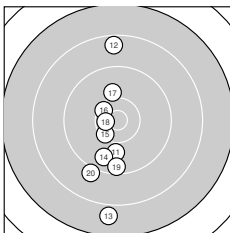

**Serie 2:**

9.9 ↓	8.5 ↑	7.9 ↓	9.7 ↙	10.4 ↘
10.4 *	10.0 ↑	10.6 *	9.5 ↓	9.1 ↙

beste Teiler: 308.1 (18.), 436.1 (16.), 478.8 (15.)  
 Trefferlage: 2.55 mm links, 4.26 mm tief  
 Streuwert: 8.73, horizontal: 1.97, vertikal: 12.19

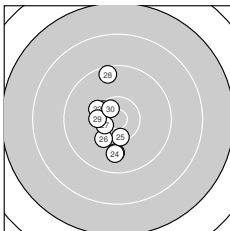

**Serie 3:**

10.4 *	10.2 ↖	9.9 ↓	9.8 ↓	10.4 *
10.2 ↙	10.5 *	9.5 ↑	10.3 ←	10.5 *

beste Teiler: 323.1 (30.), 363.4 (27.), 441.8 (21.)  
 Trefferlage: 2.57 mm links, 0.91 mm tief  
 Streuwert: 4.58, horizontal: 1.98, vertikal: 6.16





Ergebnis: **296.3** (282)  
 Serien: 99.1 98.6 98.6  
 Zähler: 15 12 3 0 0 0 0 0 0 0  
 Innenzehner: 12  
 Weitesten: 2341 (2.), 1753 (27.), 1740 (12.)  
 beste Teiler: 189.6 (7.), 243.0 (11.), 275.3 (15.)  
 Trefferlage: 0.49 mm links, 3.24 mm hoch  
 Streuwert: 6.87, horizontal: 4.65, vertikal: 8.53

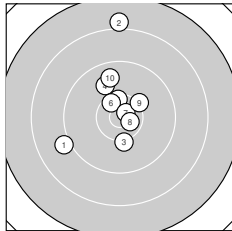
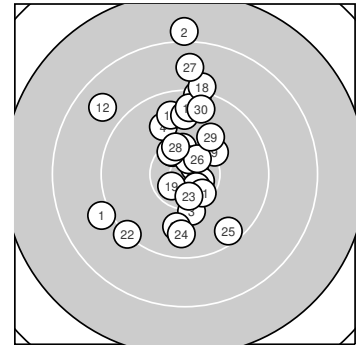

**Serie 1:**

9.0 ↙	8.0 ↑	10.2 ↓	9.9 ↖	10.4 *
10.4 *	10.7 *	10.6 *	10.2 ↗	9.7 ↗

beste Teiler: 189.6 (7.), 278.6 (8.), 409.5 (6.)  
 Trefferlage: 1.21 mm links, 3.95 mm hoch  
 Streuwert: 7.09, horizontal: 5.04, vertikal: 8.67

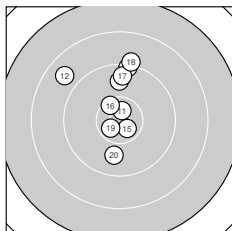

**Serie 2:**

10.6 *	8.8 ↘	9.3 ↑	9.7 ↑	10.6 *
10.4 *	9.6 ↑	9.1 ↑	10.6 *	9.9 ↓

beste Teiler: 243.0 (11.), 275.3 (15.), 293.9 (19.)  
 Trefferlage: 1.15 mm links, 5.22 mm hoch  
 Streuwert: 6.37, horizontal: 4.69, vertikal: 7.70

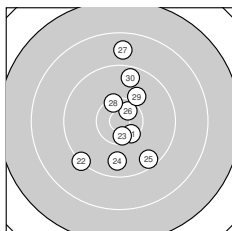

**Serie 3:**

10.4 *	9.2 ↙	10.5 *	9.7 ↓	9.5 ↘
10.5 *	8.8 ↑	10.4 *	10.0 ↗	9.6 ↑

beste Teiler: 325.0 (26.), 367.7 (23.), 420.4 (21.)  
 Trefferlage: 0.86 mm rechts, 0.55 mm hoch  
 Streuwert: 7.29, horizontal: 4.39, vertikal: 9.34



**Ergebnis: 301.5 (285)**  
**Serien: 101.7 96.4 103.4**  
**Zähler: 18 10 1 1 0 0 0 0 0 0**  
**Innenzehner: 16**  
**Weiteste: 2980 (14.), 1664 (20.), 1443 (16.)**  
**beste Teiler: 65.8 (2.), 98.5 (29.), 173.6 (28.)**  
**Trefferlage: 0.63 mm rechts, 0.61 mm tief**  
**Streuwert: 6.68, horizontal: 3.37, vertikal: 8.83**

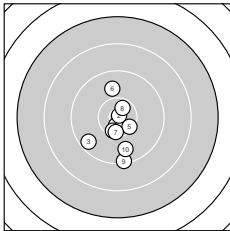
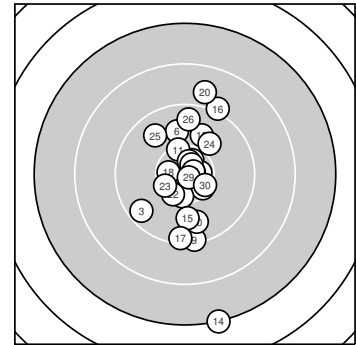

**Serie 1:**  
 10.6 \*                      10.9 \*                      9.5 ↙                      10.4 \*                      10.4 \*  
 9.9 ↑                      10.4 \*                      10.6 \*                      9.3 ↓                      9.7 ↓  
**beste Teiler: 65.8 (2.), 241.4 (1.), 311.3 (8.)**  
**Trefferlage: 0.29 mm links, 3.14 mm tief**  
**Streuwert: 4.94, horizontal: 3.36, vertikal: 6.12**

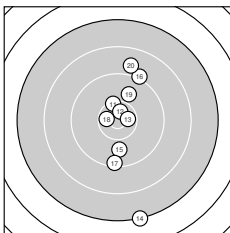

**Serie 2:**  
 10.3 ↑                      10.6 \*                      10.6 \*                      7.2 ↓                      9.9 ↓  
 9.1 ↗                      9.4 ↓                      10.5 \*                      9.9 ↗                      8.9 ↑  
**beste Teiler: 267.3 (12.), 307.0 (13.), 326.9 (18.)**  
**Trefferlage: 1.92 mm rechts, 0.54 mm tief**  
**Streuwert: 9.70, horizontal: 3.31, vertikal: 13.31**

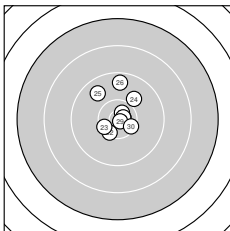

**Serie 3:**  
 10.7 \*                      10.4 \*                      10.4 \*                      10.0 ↗                      9.7 ↘  
 9.6 ↑                      10.7 \*                      10.7 \*                      10.8 \*                      10.4 \*  
**beste Teiler: 98.5 (29.), 173.6 (28.), 179.9 (21.)**  
**Trefferlage: 0.28 mm rechts, 1.83 mm hoch**  
**Streuwert: 4.15, horizontal: 3.38, vertikal: 4.80**



Ergebnis: **303.4** (290)  
 Serien: 99.2 103.6 100.6  
 Zähler: 21 8 1 0 0 0 0 0 0 0  
 Innenzehner: 12  
 Weitesten: 2090 (5.), 1506 (26.), 1484 (4.)  
 beste Teiler: 166.4 (8.), 193.6 (11.), 195.3 (15.)  
 Trefferlage: 0.83 mm links, 2.81 mm tief  
 Streuwert: 5.42, horizontal: 4.85, vertikal: 5.94

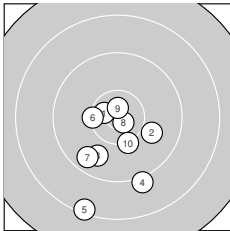
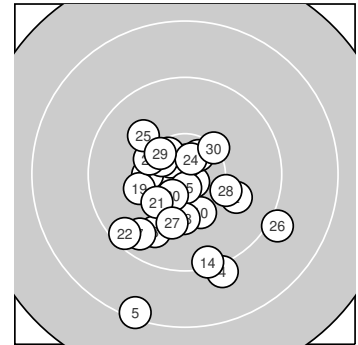

**Serie 1:**

10.6 *	9.9 ↘	9.8 ↙	9.1 ↓	8.3 ↓
10.3 ←	9.6 ↙	10.7 *	10.7 *	10.2 ↓

beste Teiler: 166.4 (8.), 199.0 (9.), 301.6 (1.)  
 Trefferlage: 0.98 mm links, 5.72 mm tief  
 Streuwert: 6.06, horizontal: 4.99, vertikal: 6.97

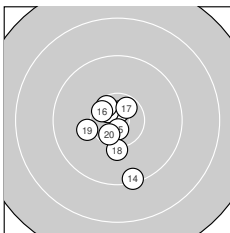

**Serie 2:**

10.7 *	10.6 *	10.5 *	9.3 ↓	10.7 *
10.5 *	10.5 *	10.2 ↓	10.1 ←	10.5 *

beste Teiler: 193.6 (11.), 195.3 (15.), 266.0 (12.)  
 Trefferlage: 1.04 mm links, 1.46 mm tief  
 Streuwert: 3.99, horizontal: 2.77, vertikal: 4.92

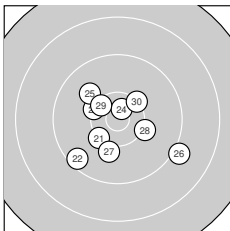

**Serie 3:**

10.2 ↙	9.4 ↙	10.3 ↖	10.7 *	9.9 ↘
9.1 ↘	10.1 ↓	10.2 ↘	10.4 *	10.3 ↗

beste Teiler: 233.4 (24.), 457.8 (29.), 550.3 (23.)  
 Trefferlage: 0.49 mm links, 1.26 mm tief  
 Streuwert: 5.90, horizontal: 6.56, vertikal: 5.17



Ergebnis: **299.1** (285)  
 Serien: 99.7 98.4 101.0  
 Zähler: 19 7 4 0 0 0 0 0 0  
 Innenzehner: 10  
 Weitester: 1873 (9.), 1737 (10.), 1674 (11.)  
 beste Teiler: 188.3 (20.), 201.1 (29.), 254.0 (4.)  
 Trefferlage: 2.76 mm rechts, 3.09 mm tief  
 Streuwert: 5.93, horizontal: 2.90, vertikal: 7.87

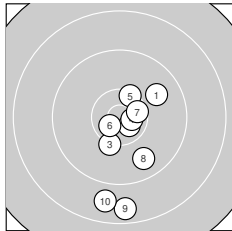
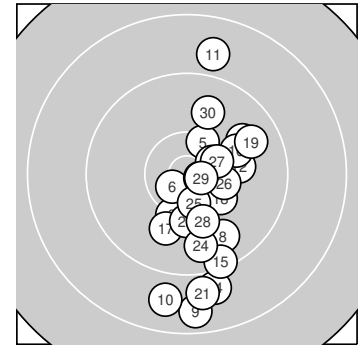

**Serie 1:**  
 9.8 ↗                      10.6 \*                      10.2 ↓                      10.6 \*                      10.3 ↗  
 10.6 \*                      10.5 \*                      9.7 ↘                      8.6 ↓                      8.8 ↓  
 beste Teiler: 254.0 (4.), 260.1 (2.), 263.8 (6.)  
 Trefferlage: 1.69 mm rechts, 4.34 mm tief  
 Streuwert: 6.25, horizontal: 3.31, vertikal: 8.19

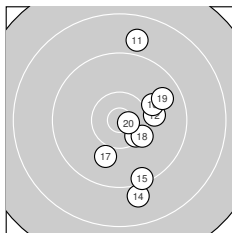

**Serie 2:**  
 8.9 ↑                      10.1 →                      10.4 \*                      9.0 ↓                      9.4 ↓  
 10.0 ↗                      10.0 ↓                      10.2 ↘                      9.7 ↗                      10.7 \*  
 beste Teiler: 188.3 (20.), 462.4 (13.), 565.1 (18.)  
 Trefferlage: 4.14 mm rechts, 1.68 mm tief  
 Streuwert: 6.76, horizontal: 3.22, vertikal: 9.00

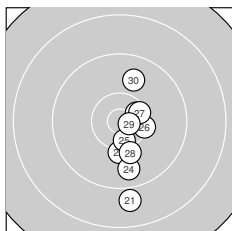

**Serie 3:**  
 8.9 ↓                      10.5 \*                      10.2 ↓                      9.7 ↓                      10.4 \*  
 10.3 →                      10.4 \*                      10.1 ↓                      10.7 \*                      9.8 ↑  
 beste Teiler: 201.1 (29.), 380.5 (22.), 403.5 (25.)  
 Trefferlage: 2.44 mm rechts, 3.26 mm tief  
 Streuwert: 4.99, horizontal: 1.50, vertikal: 6.89



Ergebnis: **296.5** (285)  
 Serien: 97.0 97.3 102.2  
 Zähler: 18 9 3 0 0 0 0 0 0  
 Innenzehner: 7  
 Weitester: 2381 (20.), 1834 (2.), 1632 (7.)  
 beste Teiler: 124.1 (9.), 195.5 (23.), 231.0 (12.)  
 Trefferlage: 1.56 mm links, 1.83 mm hoch  
 Streuwert: 6.96, horizontal: 6.30, vertikal: 7.57

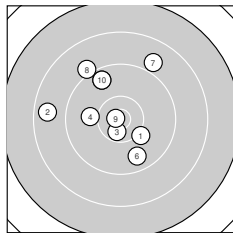
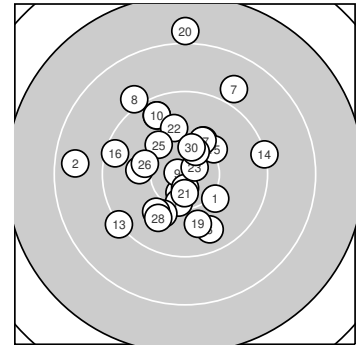

**Serie 1:**

10.1 ↘	8.7 ←	10.5 *	10.0 ←	9.6 ↖
9.7 ↘	8.9 ↗	9.1 ↘	10.8 *	9.6 ↖

beste Teiler: 124.1 (9.), 321.4 (3.), 647.8 (1.)  
 Trefferlage: 2.84 mm links, 3.24 mm hoch  
 Streuwert: 7.79, horizontal: 7.72, vertikal: 7.85

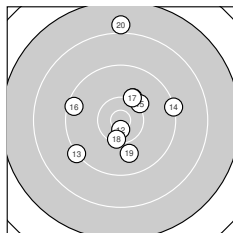

**Serie 2:**

10.2 ↗	10.7 *	9.2 ↙	9.2 →	10.2 ↗
9.4 ↖	10.2 ↗	10.3 ↓	9.9 ↓	8.0 ↑

beste Teiler: 231.0 (12.), 484.8 (18.), 630.2 (17.)  
 Trefferlage: 0.26 mm rechts, 2.22 mm hoch  
 Streuwert: 8.38, horizontal: 7.28, vertikal: 9.35

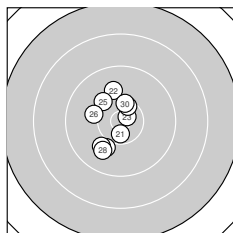

**Serie 3:**

10.6 *	10.0 ↑	10.7 *	10.0 ✓	10.1 ↘
10.1 ↖	10.0 ✓	9.9 ✓	10.4 *	10.4 *

beste Teiler: 195.5 (23.), 317.0 (21.), 411.9 (29.)  
 Trefferlage: 2.12 mm links, 0.02 mm hoch  
 Streuwert: 4.41, horizontal: 3.06, vertikal: 5.44



Ergebnis: **288.2** (275)  
 Serien: 93.6 96.3 98.3  
 Zähler: 12 15 1 0 2 0 0 0 0 0  
 Innenzehner: 5  
 Weitester: 3380 (1.), 3215 (15.), 1727 (19.)  
 beste Teiler: 180.9 (17.), 184.5 (12.), 258.3 (24.)  
 Trefferlage: 0.76 mm links, 1.38 mm hoch  
 Streuwert: 9.25, horizontal: 8.17, vertikal: 10.22

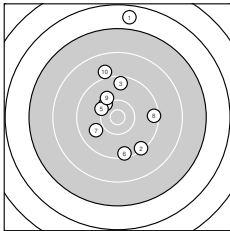
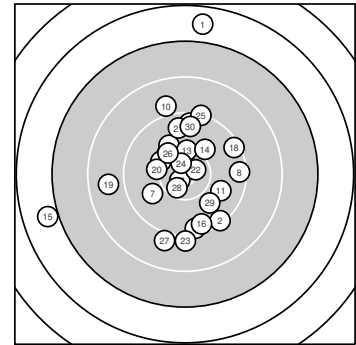

**Serie 1:**

6.7 ↑	9.3 ↘	9.5 ↑	10.2 ↖	10.2 ↖
9.4 ↓	9.9 ↗	9.4 →	10.0 ↗	9.0 ↑

beste Teiler: 599.0 (4.), 610.5 (5.), 738.0 (9.)  
 Trefferlage: 0.28 mm rechts, 4.75 mm hoch  
 Streuwert: 10.46, horizontal: 6.34, vertikal: 13.36

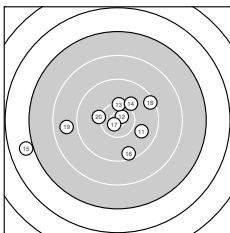

**Serie 2:**

9.8 ↘	10.7 *	10.3 ↑	10.1 ↗	6.9 ←
9.5 ↓	10.7 *	9.4 ↗	8.8 ←	10.1 ←

beste Teiler: 180.9 (17.), 184.5 (12.), 537.6 (13.)  
 Trefferlage: 2.62 mm links, 0.88 mm tief  
 Streuwert: 9.87, horizontal: 12.61, vertikal: 6.01

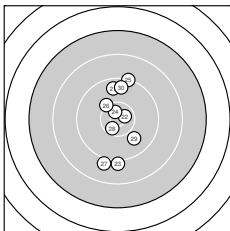

**Serie 3:**

9.6 ↑	10.6 *	9.1 ↓	10.6 *	9.2 ↑
10.2 ↖	9.0 ↓	10.5 *	9.9 ↘	9.6 ↑

beste Teiler: 258.3 (24.), 259.2 (22.), 353.6 (28.)  
 Trefferlage: 0.03 mm rechts, 0.29 mm hoch  
 Streuwert: 7.49, horizontal: 3.20, vertikal: 10.10



Ergebnis: **282.6** (267)  
 Serien: 94.2 95.9 92.5  
 Zähler: 10 9 9 2 0 0 0 0 0 0  
 Innenzehner: 7  
 Weitest: 2922 (21.), 2501 (29.), 2207 (13.)  
 beste Teiler: 164.2 (30.), 255.9 (4.), 321.3 (18.)  
 Trefferlage: 2.69 mm links, 1.91 mm tief  
 Streuwert: 10.02, horizontal: 7.53, vertikal: 12.00

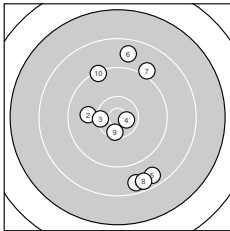
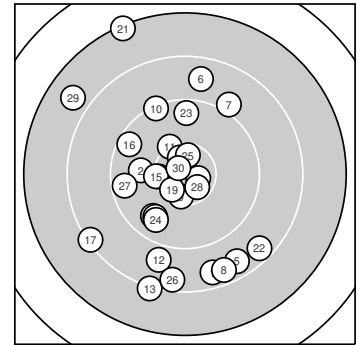

**Serie 1:**  
 8.6 ↓                      9.9 ←                      10.4 ←                      10.6 \*                      8.6 ↘  
 8.7 ↑                      9.1 ↗                      8.6 ↓                      10.4 \*                      9.3 ↖  
 beste Teiler: 255.9 (4.), 419.5 (9.), 479.2 (3.)  
 Trefferlage: 1.63 mm rechts, 1.40 mm tief  
 Streuwert: 10.16, horizontal: 6.16, vertikal: 12.99

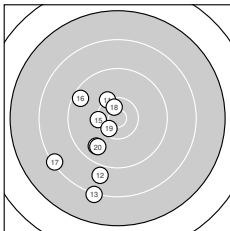

**Serie 2:**  
 10.2 ↘                      8.9 ↓                      8.2 ↓                      9.7 ✓                      10.3 ←  
 9.5 ↖                      8.3 ↙                      10.5 \*                      10.5 \*                      9.8 ✓  
 beste Teiler: 321.3 (18.), 372.7 (19.), 536.4 (15.)  
 Trefferlage: 6.19 mm links, 5.42 mm tief  
 Streuwert: 7.24, horizontal: 4.71, vertikal: 9.08

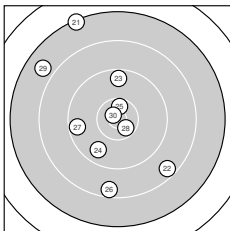

**Serie 3:**  
 7.3 ↖                      8.5 ↘                      9.5 ↑                      9.7 ✓                      10.5 \*  
 8.5 ↓                      9.5 ←                      10.5 \*                      7.8 ↖                      10.7 \*  
 beste Teiler: 164.2 (30.), 328.9 (28.), 354.1 (25.)  
 Trefferlage: 3.53 mm links, 1.07 mm hoch  
 Streuwert: 11.75, horizontal: 9.35, vertikal: 13.74



Ergebnis: **293.4** (279)  
 Serien: 94.9 98.1 100.4  
 Zähler: 12 15 3 0 0 0 0 0 0 0  
 Innenzehner: 4  
 Weitestе: 1721 (4.), 1674 (5.), 1638 (7.)  
 beste Teiler: 358.2 (22.), 406.1 (24.), 432.9 (29.)  
 Trefferlage: 1.30 mm rechts, 4.39 mm tief  
 Streuwert: 6.62, horizontal: 5.81, vertikal: 7.33

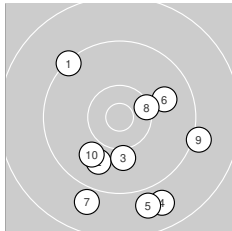
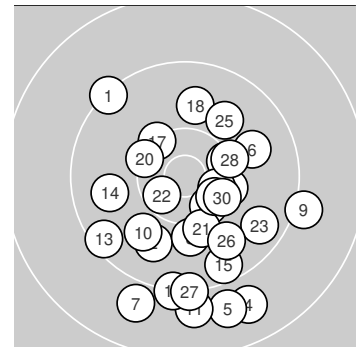

**Serie 1:**

9.3 ↘	9.8 ↙	10.0 ↓	8.8 ↓	8.9 ↓
9.9 →	8.9 ↙	10.3 →	9.1 →	9.9 ↙

beste Teiler: 518.2 (8.), 737.7 (3.), 840.8 (10.)  
 Trefferlage: 1.67 mm rechts, 5.80 mm tief  
 Streuwert: 8.12, horizontal: 7.53, vertikal: 8.67

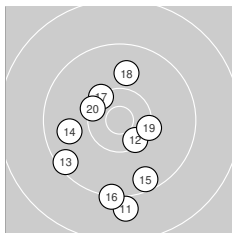

**Serie 2:**

9.0 ↓	10.4 *	9.4 ↙	9.8 ←	9.5 ↓
9.2 ↓	10.3 ↘	9.9 ↑	10.3 →	10.3 ↘

beste Teiler: 454.9 (12.), 528.9 (20.), 539.4 (17.)  
 Trefferlage: 1.33 mm links, 4.01 mm tief  
 Streuwert: 6.77, horizontal: 5.34, vertikal: 7.95

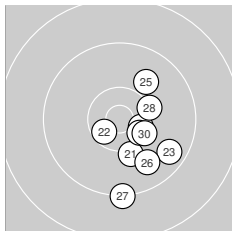

**Serie 3:**

10.1 ↓	10.5 *	9.6 ↘	10.4 *	9.9 ↗
9.8 ↘	9.2 ↓	10.2 →	10.4 *	10.3 ↘

beste Teiler: 358.2 (22.), 406.1 (24.), 432.9 (29.)  
 Trefferlage: 3.58 mm rechts, 3.36 mm tief  
 Streuwert: 4.54, horizontal: 3.14, vertikal: 5.61





**Ergebnis: 268.0** (255)  
**Serien:** 85.3 88.7 94.0  
**Zähler:** 4 13 10 1 1 1 0 0 0 0  
**Innenzehner:** 2  
**Weiteste:** 4125 (3.), 3397 (1.), 2556 (2.)  
**beste Teiler:** 173.1 (21.), 464.4 (8.), 585.8 (26.)  
**Trefferlage:** 6.97 mm rechts, 9.50 mm hoch  
**Streuwert:** 9.82, horizontal: 6.31, vertikal: 12.36

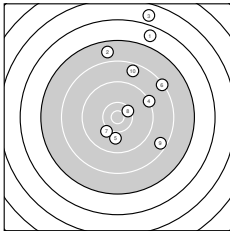
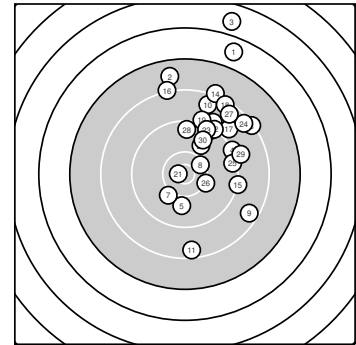

**Serie 1:**  
 6.7 ↗                      7.8 ↑                      5.8 ↑                      9.2 ↗                      9.9 ↓  
 8.3 ↘                      10.1 ↙                      10.4 \*                      8.5 ↘                      8.6 ↑  
**beste Teiler:** 464.4 (8.), 694.8 (7.), 818.2 (5.)  
**Trefferlage:** 7.15 mm rechts, 11.17 mm hoch  
**Streuwert:** 13.46, horizontal: 8.17, vertikal: 17.20

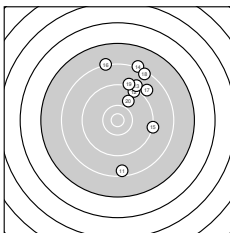

**Serie 2:**  
 8.5 ↓                      9.3 ↗                      9.0 ↗                      8.2 ↗                      9.2 →  
 8.2 ↑                      8.9 ↗                      8.4 ↗                      9.1 ↗                      9.9 ↗  
**beste Teiler:** 848.8 (20.), 1282.1 (12.), 1394.5 (15.)  
**Trefferlage:** 6.24 mm rechts, 9.56 mm hoch  
**Streuwert:** 9.54, horizontal: 5.26, vertikal: 12.42

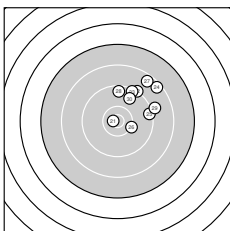

**Serie 3:**  
 10.7 \*                      9.2 ↗                      9.4 ↗                      8.4 ↗                      9.4 →  
 10.2 ↘                      8.5 ↗                      9.5 ↑                      9.0 →                      9.7 ↗  
**beste Teiler:** 173.1 (21.), 585.8 (26.), 997.0 (30.)  
**Trefferlage:** 7.53 mm rechts, 7.77 mm hoch  
**Streuwert:** 5.88, horizontal: 5.75, vertikal: 6.00



Ergebnis: **290.6** (278)  
 Serien: 95.1 95.7 99.8  
 Zähler: 15 9 5 1 0 0 0 0 0 0  
 Innenzehner: 6  
 Weitesten: 2887 (19.), 2211 (8.), 2042 (11.)  
 beste Teiler: 223.6 (9.), 280.9 (25.), 288.5 (24.)  
 Trefferlage: 2.26 mm links, 4.08 mm hoch  
 Streuwert: 8.00, horizontal: 7.37, vertikal: 8.57

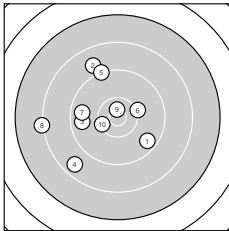
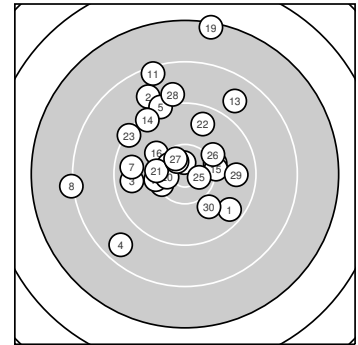

**Serie 1:**

9.6 ↘	8.9 ↘	9.7 ←	8.6 ↙	9.2 ↑
10.2 →	9.7 ←	8.2 ←	10.7 *	10.3 ←

beste Teiler: 223.6 (9.), 490.9 (10.), 621.5 (6.)  
 Trefferlage: 5.69 mm links, 0.75 mm hoch  
 Streuwert: 8.73, horizontal: 8.99, vertikal: 8.47

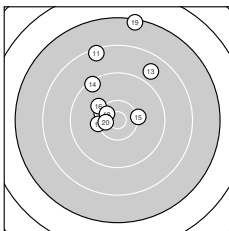

**Serie 2:**

8.4 ↑	10.3 ↘	8.8 ↗	9.4 ↘	10.2 →
10.1 ↘	10.2 ←	10.5 *	7.3 ↑	10.5 *

beste Teiler: 350.8 (20.), 361.1 (18.), 502.2 (12.)  
 Trefferlage: 1.51 mm links, 7.97 mm hoch  
 Streuwert: 8.22, horizontal: 6.04, vertikal: 9.93

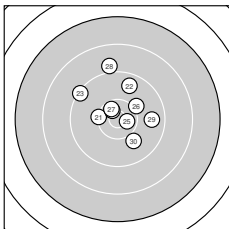

**Serie 3:**

10.3 ←	9.7 ↑	9.3 ↘	10.6 *	10.6 *
10.1 ↗	10.5 *	9.0 ↑	9.7 →	10.0 ↘

beste Teiler: 280.9 (25.), 288.5 (24.), 346.1 (27.)  
 Trefferlage: 0.41 mm rechts, 3.54 mm hoch  
 Streuwert: 6.05, horizontal: 6.02, vertikal: 6.08



**Ergebnis: 283.5 (270)**  
**Serien: 92.1 93.7 97.7**  
**Zähler: 7 16 7 0 0 0 0 0 0 0**  
**Innenzehner: 2**  
**Weiteste: 2234 (12.), 2132 (15.), 2038 (20.)**  
**beste Teiler: 323.0 (28.), 452.0 (25.), 479.3 (22.)**  
**Trefferlage: 4.02 mm rechts, 2.98 mm tief**  
**Streuwert: 8.77, horizontal: 8.28, vertikal: 9.23**

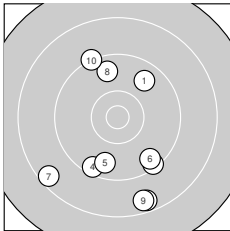
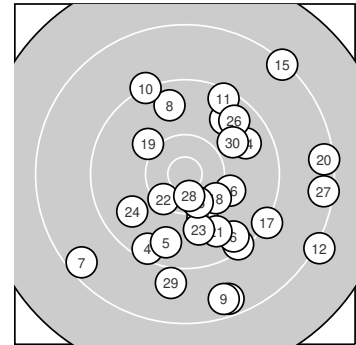

**Serie 1:**

9.7 ↗	8.5 ↘	9.3 ↘	9.4 ↙	9.7 ↙
9.5 ↘	8.5 ↗	9.7 ↑	8.6 ↘	9.2 ↗

**beste Teiler: 989.4 (1.), 1026.9 (8.), 1030.6 (5.)**  
**Trefferlage: 0.14 mm rechts, 5.86 mm tief**  
**Streuwert: 9.78, horizontal: 7.59, vertikal: 11.57**

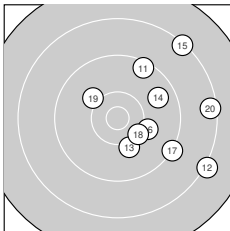

**Serie 2:**

9.4 ↗	8.2 ↘	10.1 ↘	9.7 ↗	8.3 ↗
10.1 ↘	9.2 ↘	10.2 ↘	10.1 ↘	8.4 →

**beste Teiler: 569.9 (18.), 682.9 (13.), 695.0 (19.)**  
**Trefferlage: 8.86 mm rechts, 0.78 mm hoch**  
**Streuwert: 8.16, horizontal: 7.89, vertikal: 8.42**

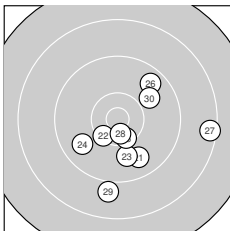

**Serie 3:**

9.8 ↘	10.4 ↗	9.9 ↘	9.8 ↗	10.4 *
9.6 ↗	8.4 →	10.5 *	9.0 ↓	9.9 ↗

**beste Teiler: 323.0 (28.), 452.0 (25.), 479.3 (22.)**  
**Trefferlage: 3.05 mm rechts, 3.86 mm tief**  
**Streuwert: 7.11, horizontal: 7.58, vertikal: 6.62**



**Ergebnis:** **262.9** (249)  
**Serien:** 88.4 87.5 87.0  
**Zähler:** 4 12 7 5 0 2 0 0 0 0  
**Innenzehner:** 2  
**Weiteste:** 4599 (17.), 4012 (26.), 3014 (29.)  
**beste Teiler:** 329.6 (20.), 432.0 (4.), 507.0 (24.)  
**Trefferlage:** 2.63 mm rechts, 4.26 mm tief  
**Streuwert:** 13.91, horizontal: 12.29, vertikal: 15.36

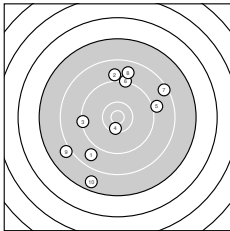
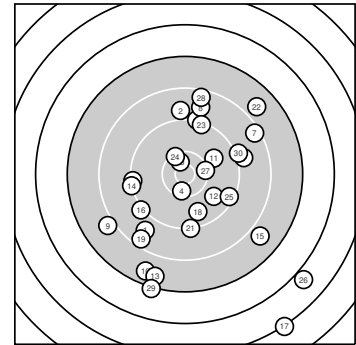

**Serie 1:**

8.8 ↙	8.9 ↑	9.3 ←	10.4 *	9.0 →
9.2 ↑	8.4 ↗	8.8 ↑	8.0 ↙	7.6 ↓

**beste Teiler:** 432.0 (4.), 1328.1 (3.), 1400.8 (6.)  
**Trefferlage:** 1.52 mm links, 0.36 mm hoch  
**Streuwert:** 13.20, horizontal: 11.97, vertikal: 14.32

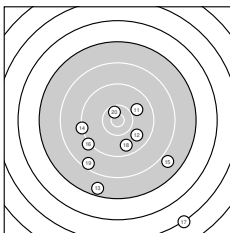

**Serie 2:**

9.9 ↗	9.8 ↘	7.6 ↓	9.2 ←	7.9 ↘
9.2 ↙	5.2 ↘	9.7 ↓	8.5 ↙	10.5 *

**beste Teiler:** 329.6 (20.), 834.7 (11.), 919.6 (12.)  
**Trefferlage:** 1.75 mm rechts, 11.63 mm tief  
**Streuwert:** 13.15, horizontal: 13.20, vertikal: 13.11

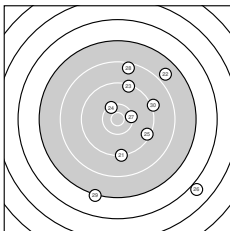

**Serie 3:**

9.2 ↓	7.8 ↗	9.3 ↑	10.3 ↖	9.4 ↘
5.9 ↘	10.3 →	8.5 ↑	7.2 ↓	9.1 →

**beste Teiler:** 507.0 (24.), 527.4 (27.), 1255.7 (25.)  
**Trefferlage:** 7.67 mm rechts, 1.53 mm tief  
**Streuwert:** 14.35, horizontal: 11.00, vertikal: 17.05



Ergebnis: **293.2** (279)  
 Serien: 95.7 97.9 99.6  
 Zähler: 15 12 0 3 0 0 0 0 0 0  
 Innenzehner: 8  
 Weitester: 2858 (10.), 2611 (7.), 2537 (11.)  
 beste Teiler: 79.8 (29.), 205.8 (30.), 236.2 (4.)  
 Trefferlage: 0.03 mm links, 0.29 mm tief  
 Streuwert: 8.47, horizontal: 3.77, vertikal: 11.37

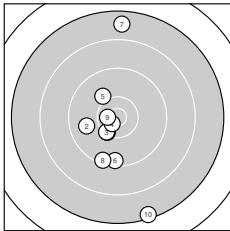
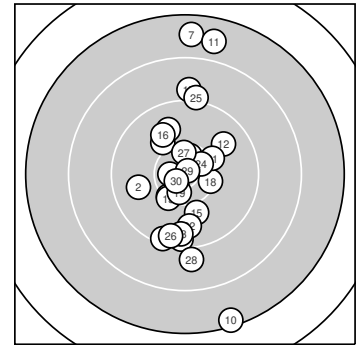

**Serie 1:**

10.3 ↘	9.8 ←	10.3 ↘	10.7 *	10.1 ↘
9.4 ↓	7.7 ↑	9.4 ↓	10.6 *	7.4 ↓

beste Teiler: 236.2 (4.), 282.0 (9.), 512.2 (1.)  
 Trefferlage: 1.82 mm links, 3.20 mm tief  
 Streuwert: 10.20, horizontal: 4.47, vertikal: 13.71

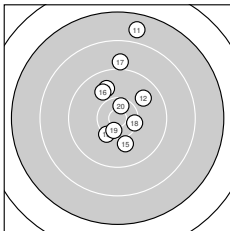

**Serie 2:**

7.8 ↑	9.8 ↗	10.3 ↘	9.8 ↖	10.0 ↓
9.9 ↘	9.0 ↑	10.3 →	10.5 *	10.5 *

beste Teiler: 357.0 (19.), 358.2 (20.), 494.9 (18.)  
 Trefferlage: 0.98 mm rechts, 4.89 mm hoch  
 Streuwert: 7.50, horizontal: 3.91, vertikal: 9.87

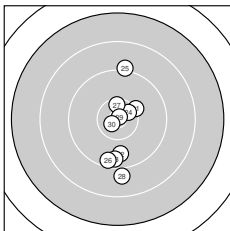

**Serie 3:**

10.2 ↗	9.7 ↓	9.6 ↓	10.5 *	9.1 ↑
9.5 ↓	10.4 *	9.0 ↓	10.9 *	10.7 *

beste Teiler: 79.8 (29.), 205.8 (30.), 358.1 (24.)  
 Trefferlage: 0.74 mm rechts, 2.57 mm tief  
 Streuwert: 6.75, horizontal: 2.28, vertikal: 9.27



Ergebnis: **281.2** (269)  
 Serien: 93.3 93.3 94.6  
 Zähler: 9 11 10 0 0 0 0 0 0 0  
 Innenzehner: 2  
 Weitester: 2368 (27.), 2153 (19.), 2147 (6.)  
 beste Teiler: 336.0 (4.), 402.3 (16.), 483.0 (20.)  
 Trefferlage: 7.46 mm links, 3.34 mm tief  
 Streuwert: 8.06, horizontal: 5.46, vertikal: 10.00

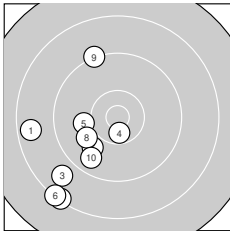
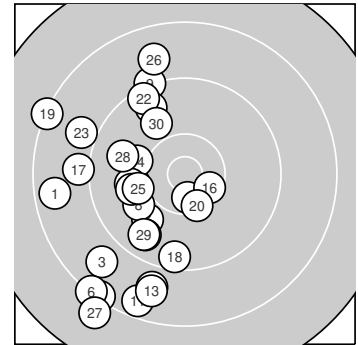

**Serie 1:**

8.6 ←	8.3 ↙	8.8 ↘	10.5 *	10.0 ←
8.3 ↘	9.9 ↘	10.0 ↘	9.2 ↗	9.7 ↘

beste Teiler: 336.0 (4.), 737.0 (5.), 792.6 (8.)  
 Trefferlage: 8.57 mm links, 6.07 mm tief  
 Streuwert: 7.33, horizontal: 5.43, vertikal: 8.83

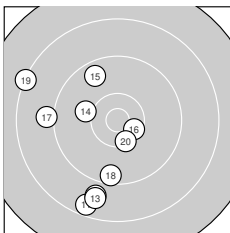

**Serie 2:**

8.5 ↓	8.8 ↓	8.8 ↓	10.1 ←	9.6 ↘
10.4 *	9.0 ←	9.5 ↓	8.3 ↖	10.3 ↓

beste Teiler: 402.3 (16.), 483.0 (20.), 711.5 (14.)  
 Trefferlage: 5.92 mm links, 4.85 mm tief  
 Streuwert: 8.88, horizontal: 7.08, vertikal: 10.37

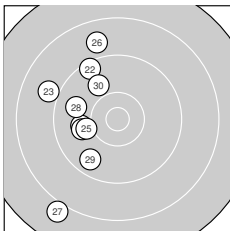

**Serie 3:**

10.0 ←	9.4 ↘	9.0 ↖	10.0 ←	10.1 ←
8.8 ↗	8.0 ↘	9.8 ↖	9.6 ↘	9.9 ↘

beste Teiler: 700.3 (25.), 794.6 (21.), 795.1 (24.)  
 Trefferlage: 7.91 mm links, 0.90 mm hoch  
 Streuwert: 7.69, horizontal: 3.50, vertikal: 10.30



Ergebnis: **295.4** (281)  
 Serien: 102.1 98.6 94.7  
 Zähler: 16 12 1 0 0 1 0 0 0 0  
 Innenzehner: 8  
 Weitestе: 4295 (30.), 2041 (28.), 1341 (15.)  
 beste Teiler: 143.3 (22.), 183.4 (25.), 281.0 (4.)  
 Trefferlage: 2.97 mm links, 2.89 mm tief  
 Streuwert: 7.84, horizontal: 8.16, vertikal: 7.51

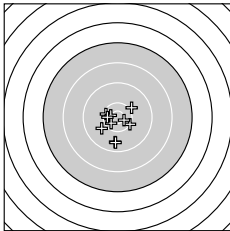
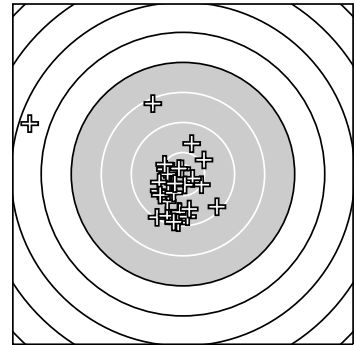

**Serie 1:**

10.3 ↖	10.2 ↘	10.0 ↙	10.6 *	10.1 ↗
9.7 ↓	9.7 ↓	10.6 *	10.5 *	10.4 *

beste Teiler: 281.0 (4.), 283.1 (8.), 351.7 (9.)  
 Trefferlage: 0.91 mm links, 2.50 mm tief  
 Streuwert: 4.33, horizontal: 4.06, vertikal: 4.59

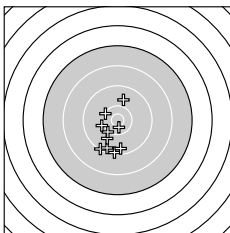

**Serie 2:**

9.9 ↑	9.3 ↓	10.3 ↖	10.6 *	9.3 ↙
9.5 ↓	9.5 ↙	9.9 ↘	10.2 ↘	10.1 ↖

beste Teiler: 290.5 (14.), 553.4 (13.), 611.5 (19.)  
 Trefferlage: 2.75 mm links, 5.31 mm tief  
 Streuwert: 5.39, horizontal: 3.24, vertikal: 6.91

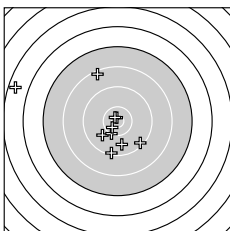

**Serie 3:**

9.4 ↘	10.8 *	9.9 ↙	9.3 ↓	10.7 *
10.3 ↙	10.5 *	8.4 ↗	9.8 ↓	5.6 ↖

beste Teiler: 143.3 (22.), 183.4 (25.), 331.1 (27.)  
 Trefferlage: 5.26 mm links, 0.86 mm tief  
 Streuwert: 11.80, horizontal: 13.30, vertikal: 10.09



Ergebnis: **271.2** (258)  
 Serien: 89.7 92.6 88.9  
 Zähler: 6 10 11 2 1 0 0 0 0 0  
 Innenzehner: 1  
 Weitesten: 3388 (7.), 2881 (20.), 2481 (28.)  
 beste Teiler: 429.2 (6.), 517.5 (12.), 538.1 (16.)  
 Trefferlage: 4.73 mm rechts, 1.86 mm tief  
 Streuwert: 11.49, horizontal: 7.17, vertikal: 14.59

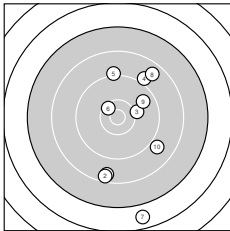
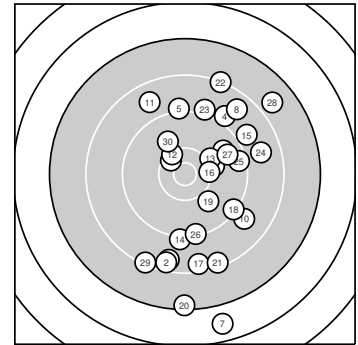

**Serie 1:**

8.6 ↓	8.5 ↓	10.1 →	9.0 ↗	9.1 ↑
10.4 *	6.7 ↓	8.7 ↗	9.7 ↗	8.9 ↘

beste Teiler: 429.2 (6.), 662.9 (3.), 987.4 (9.)  
 Trefferlage: 4.41 mm rechts, 2.94 mm tief  
 Streuwert: 12.55, horizontal: 6.69, vertikal: 16.43

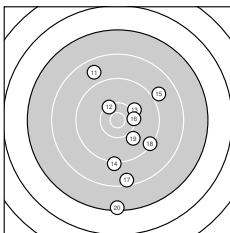

**Serie 2:**

8.7 ↘	10.3 ↘	10.1 ↗	9.2 ↓	8.9 ↗
10.3 →	8.5 ↓	9.3 ↘	10.0 ↘	7.3 ↓

beste Teiler: 517.5 (12.), 538.1 (16.), 653.4 (13.)  
 Trefferlage: 3.14 mm rechts, 4.38 mm tief  
 Streuwert: 10.66, horizontal: 6.36, vertikal: 13.68

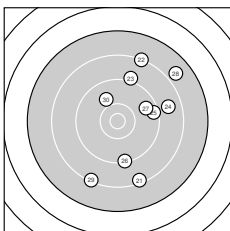

**Serie 3:**

8.4 ↓	8.2 ↗	9.1 ↑	8.8 →	9.4 →
9.3 ↓	9.7 ↗	7.8 ↗	8.3 ↓	9.9 ↘

beste Teiler: 809.1 (30.), 1028.2 (27.), 1221.6 (25.)  
 Trefferlage: 6.63 mm rechts, 1.72 mm hoch  
 Streuwert: 11.82, horizontal: 8.58, vertikal: 14.36





Ergebnis: **292.8** (279)  
 Serien: 97.1 96.3 99.4  
 Zähler: 13 13 4 0 0 0 0 0 0  
 Innenzehner: 5  
 Weitester: 2096 (19.), 1887 (25.), 1884 (4.)  
 beste Teiler: 83.1 (27.), 173.0 (22.), 194.1 (1.)  
 Trefferlage: 1.31 mm rechts, 3.76 mm tief  
 Streuwert: 7.28, horizontal: 5.10, vertikal: 8.95

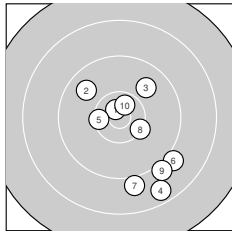
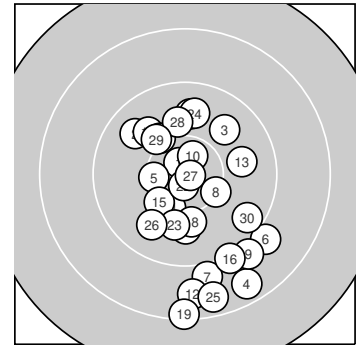

**Serie 1:**

10.7 *	9.7 ↘	9.8 ↗	8.6 ↓	10.4 *
9.0 ↘	9.0 ↓	10.3 ↘	9.0 ↓	10.6 *

beste Teiler: 194.1 (1.), 296.6 (10.), 468.4 (5.)  
 Trefferlage: 3.28 mm rechts, 3.94 mm tief  
 Streuwert: 7.62, horizontal: 6.33, vertikal: 8.73

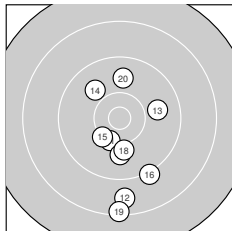

**Serie 2:**

10.3 ↙	8.7 ↓	9.9 →	9.9 ↘	10.2 ↙
9.2 ↘	9.9 ↓	10.1 ↓	8.3 ↓	9.8 ↑

beste Teiler: 547.0 (11.), 569.7 (15.), 720.5 (18.)  
 Trefferlage: 0.66 mm rechts, 5.88 mm tief  
 Streuwert: 7.54, horizontal: 4.29, vertikal: 9.77

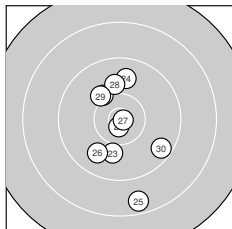

**Serie 3:**

10.1 ↘	10.7 *	10.0 ↓	9.8 ↑	8.6 ↓
9.8 ↗	10.8 *	10.0 ↑	10.1 ↘	9.5 ↘

beste Teiler: 83.1 (27.), 173.0 (22.), 652.9 (21.)  
 Trefferlage: 0.00 mm , 1.44 mm tief  
 Streuwert: 6.86, horizontal: 4.32, vertikal: 8.68



Ergebnis: **257.4** (242)  
 Serien: 84.7 88.0 84.7  
 Zähler: 2 10 10 6 0 2 0 0 0 0  
 Innenzehner: 0  
 Weitesten: 4223 (15.), 4090 (26.), 2840 (13.)  
 beste Teiler: 502.8 (20.), 612.3 (6.), 907.3 (16.)  
 Trefferlage: 10.23 mm rechts, 1.17 mm tief  
 Streuwert: 13.08, horizontal: 9.74, vertikal: 15.73

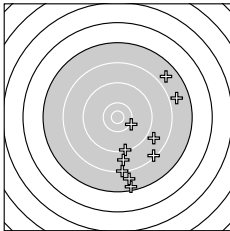
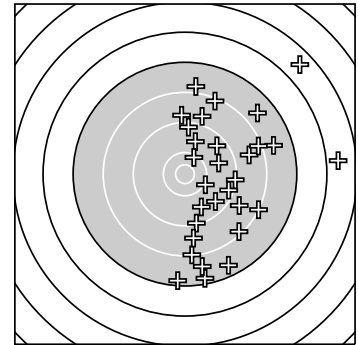

**Serie 1:**

8.3 ↓	9.3 ↓	8.9 ↘	7.4 ↓	8.3 ↘
10.2 ↘	8.8 ↓	7.8 ↓	7.8 ↗	7.9 →

beste Teiler: 612.3 (6.), 1337.9 (2.), 1668.0 (3.)  
 Trefferlage: 9.41 mm rechts, 10.64 mm tief  
 Streuwert: 11.42, horizontal: 7.84, vertikal: 14.12

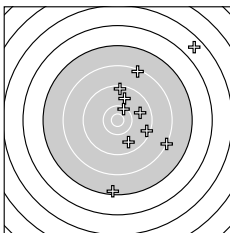

**Serie 2:**

9.4 ↘	8.2 ↘	7.4 ↓	8.3 ↗	5.7 ↗
9.8 ↗	9.4 ↑	9.7 ↓	9.8 →	10.3 ↗

beste Teiler: 502.8 (20.), 907.3 (16.), 945.2 (19.)  
 Trefferlage: 8.72 mm rechts, 2.62 mm hoch  
 Streuwert: 13.49, horizontal: 9.85, vertikal: 16.34

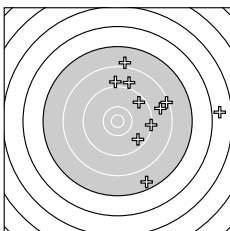

**Serie 3:**

9.3 →	9.0 ↑	8.7 →	8.9 ↗	9.6 ↘
5.8 →	9.5 ↗	8.3 →	8.0 ↑	7.6 ↓

beste Teiler: 1089.8 (25.), 1135.5 (27.), 1346.6 (21.)  
 Trefferlage: 12.55 mm rechts, 4.49 mm hoch  
 Streuwert: 12.60, horizontal: 11.74, vertikal: 13.40



Ergebnis: **291.7** (277)  
 Serien: 98.1 98.7 94.9  
 Zähler: 11 15 4 0 0 0 0 0 0 0  
 Innenzehner: 6  
 Weitester: 2278 (21.), 2012 (5.), 1903 (22.)  
 beste Teiler: 247.6 (8.), 254.4 (15.), 254.7 (16.)  
 Trefferlage: 0.22 mm rechts, 0.11 mm tief  
 Streuwert: 8.01, horizontal: 7.42, vertikal: 8.57

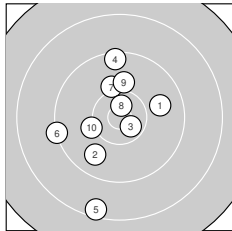
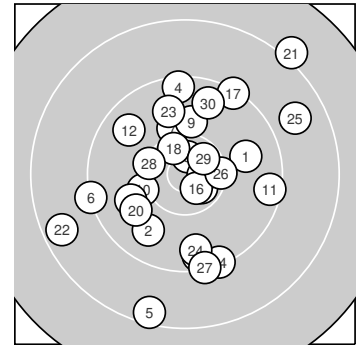

**Serie 1:**  
 9.8 →                      9.8 ↙                      10.6 \*                      9.4 ↑                      8.4 ↓  
 9.2 ←                      10.1 ↑                      10.6 \*                      10.0 ↑                      10.2 ←  
 beste Teiler: 247.6 (8.), 304.2 (3.), 633.4 (10.)  
 Trefferlage: 1.98 mm links, 0.36 mm tief  
 Streuwert: 7.56, horizontal: 5.85, vertikal: 8.94

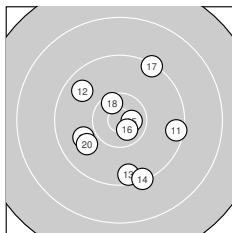

**Serie 2:**  
 9.4 →                      9.7 ↘                      9.5 ↓                      9.3 ↓                      10.6 \*  
 10.6 \*                      9.3 ↗                      10.5 \*                      9.9 ←                      9.9 ←  
 beste Teiler: 254.4 (15.), 254.7 (16.), 394.8 (18.)  
 Trefferlage: 0.55 mm rechts, 1.56 mm tief  
 Streuwert: 7.01, horizontal: 6.61, vertikal: 7.39

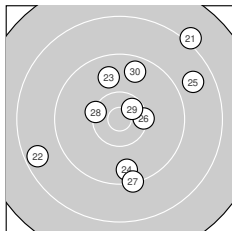

**Serie 3:**  
 8.1 ↗                      8.6 ←                      9.8 ↑                      9.6 ↓                      8.8 →  
 10.3 →                      9.3 ↓                      10.3 ←                      10.5 \*                      9.6 ↑  
 beste Teiler: 340.9 (29.), 508.2 (26.), 528.3 (28.)  
 Trefferlage: 2.11 mm rechts, 1.60 mm hoch  
 Streuwert: 9.64, horizontal: 9.48, vertikal: 9.81



Ergebnis: **308.6** (291)  
 Serien: 102.0 102.6 104.0  
 Zähler: 21 9 0 0 0 0 0 0 0 0  
 Innenzehner: 16  
 Weitestе: 1308 (6.), 1153 (19.), 1116 (23.)  
 beste Teiler: 22.8 (16.), 70.3 (26.), 91.2 (29.)  
 Trefferlage: 0.53 mm rechts, 0.39 mm hoch  
 Streuwert: 4.57, horizontal: 2.78, vertikal: 5.84

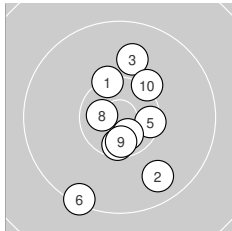
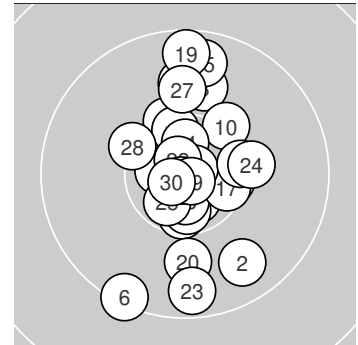

**Serie 1:**

10.3 ↗	9.7 ↘	9.9 ↗	10.5 *	10.4 *
9.3 ↘	10.6 *	10.6 *	10.5 *	10.2 ↗

beste Teiler: 253.5 (8.), 271.0 (7.), 349.6 (9.)  
 Trefferlage: 0.66 mm rechts, 1.25 mm tief  
 Streuwert: 5.00, horizontal: 3.46, vertikal: 6.17

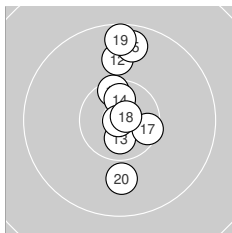

**Serie 2:**

10.4 *	9.9 ↗	10.6 *	10.6 *	9.6 ↗
10.9 *	10.4 *	10.8 *	9.5 ↗	9.9 ↘

beste Teiler: 22.8 (16.), 104.8 (18.), 257.0 (13.)  
 Trefferlage: 0.57 mm rechts, 2.62 mm hoch  
 Streuwert: 4.56, horizontal: 1.41, vertikal: 6.30

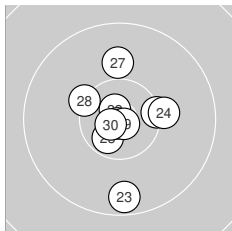

**Serie 3:**

10.3 →	10.8 *	9.6 ↘	10.1 →	10.6 *
10.9 *	9.9 ↗	10.2 ↘	10.8 *	10.8 *

beste Teiler: 70.3 (26.), 91.2 (29.), 148.3 (30.)  
 Trefferlage: 0.36 mm rechts, 0.18 mm tief  
 Streuwert: 4.13, horizontal: 3.31, vertikal: 4.81





Ergebnis: **282.4** (269)  
 Serien: 90.6 95.6 96.2  
 Zähler: 8 16 3 3 0 0 0 0 0 0  
 Innenzehner: 5  
 Weitester: 2724 (24.), 2597 (1.), 2590 (5.)  
 beste Teiler: 180.8 (13.), 417.2 (30.), 452.5 (3.)  
 Trefferlage: 2.54 mm rechts, 1.55 mm tief  
 Streuwert: 9.88, horizontal: 6.25, vertikal: 12.50

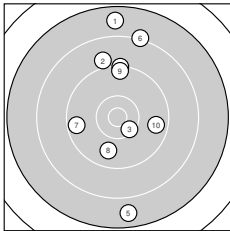
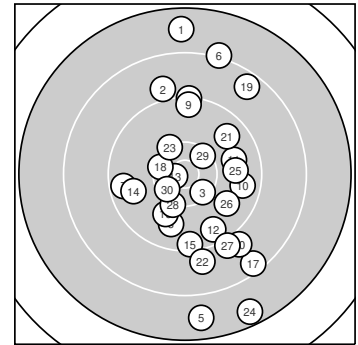

**Serie 1:**

7.7 ↑	9.0 ↑	10.4 *	9.3 ↑	7.7 ↓
8.2 ↑	9.5 ←	9.8 ↓	9.4 ↑	9.6 →

beste Teiler: 452.5 (3.), 928.0 (8.), 1052.9 (10.)  
 Trefferlage: 0.57 mm rechts, 4.64 mm hoch  
 Streuwert: 11.90, horizontal: 5.81, vertikal: 15.79

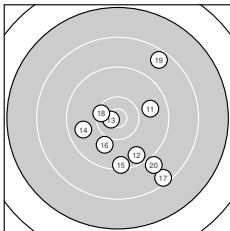

**Serie 2:**

9.8 →	9.6 ↓	10.7 *	9.7 ←	9.4 ↓
10.0 ↓	8.4 ↓	10.4 *	8.6 ↗	9.0 ↓

beste Teiler: 180.8 (13.), 458.8 (18.), 794.2 (16.)  
 Trefferlage: 2.89 mm rechts, 4.20 mm tief  
 Streuwert: 8.54, horizontal: 7.50, vertikal: 9.47

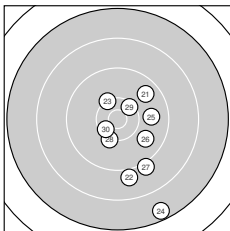

**Serie 3:**

9.7 ↗	9.0 ↓	10.3 ↘	7.5 ↓	9.8 →
9.8 ↘	9.1 ↓	10.2 ↓	10.4 *	10.4 *

beste Teiler: 417.2 (30.), 455.4 (29.), 553.4 (23.)  
 Trefferlage: 4.15 mm rechts, 5.09 mm tief  
 Streuwert: 8.02, horizontal: 5.35, vertikal: 10.00



Ergebnis: **274.4** (260)  
 Serien: 90.2 89.8 94.4  
 Zähler: 6 12 9 2 1 0 0 0 0 0  
 Innenzehner: 2  
 Weitesten: 3450 (13.), 2723 (8.), 2568 (9.)  
 beste Teiler: 294.0 (6.), 462.0 (11.), 533.4 (25.)  
 Trefferlage: 4.39 mm rechts, 0.73 mm hoch  
 Streuwert: 11.26, horizontal: 12.57, vertikal: 9.77

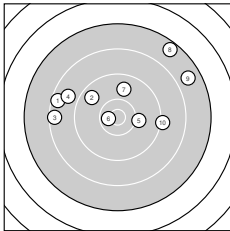
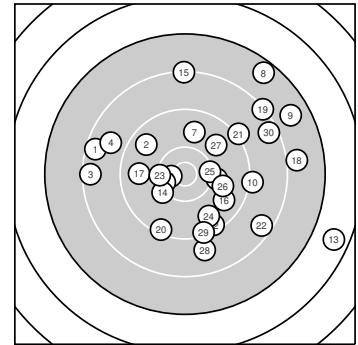

**Serie 1:**

8.5 ←	9.7 ↘	8.4 ←	8.8 ↖	10.1 →
10.6 *	9.8 ↑	7.5 ↗	7.7 ↗	9.1 →

beste Teiler: 294.0 (6.), 683.6 (5.), 914.1 (7.)  
 Trefferlage: 0.36 mm links, 5.80 mm hoch  
 Streuwert: 12.02, horizontal: 15.36, vertikal: 7.29

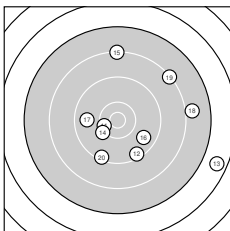

**Serie 2:**

10.4 *	9.4 ↘	6.6 ↘	10.2 ↙	8.2 ↑
9.7 ↘	9.7 ←	8.0 →	8.3 ↗	9.3 ↙

beste Teiler: 462.0 (11.), 614.4 (14.), 974.0 (17.)  
 Trefferlage: 6.21 mm rechts, 0.90 mm tief  
 Streuwert: 12.62, horizontal: 13.81, vertikal: 11.32

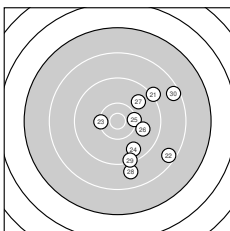

**Serie 3:**

9.2 ↗	8.5 ↘	10.3 ←	9.7 ↘	10.3 →
9.9 ↘	9.8 ↗	8.9 ↓	9.3 ↘	8.5 ↗

beste Teiler: 533.4 (25.), 534.4 (23.), 842.9 (26.)  
 Trefferlage: 7.33 mm rechts, 2.69 mm tief  
 Streuwert: 7.93, horizontal: 6.65, vertikal: 9.02



Ergebnis: **281.1** (266)  
 Serien: 92.9 94.5 93.7  
 Zähler: 7 13 9 1 0 0 0 0 0 0  
 Innenzehner: 3  
 Weitester: 2442 (10.), 2226 (20.), 1970 (25.)  
 beste Teiler: 128.9 (13.), 255.9 (14.), 469.1 (5.)  
 Trefferlage: 3.64 mm links, 3.74 mm hoch  
 Streuwert: 9.28, horizontal: 9.01, vertikal: 9.55

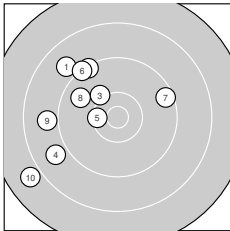
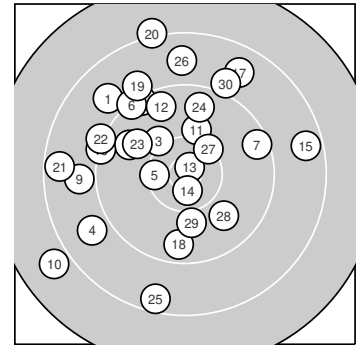

**Serie 1:**

8.9 ↘	9.3 ↘	10.1 ↘	8.9 ←	10.4 *
9.3 ↘	9.5 →	9.7 ↘	8.9 ←	7.9 ↙

beste Teiler: 469.1 (5.), 651.2 (3.), 966.1 (8.)  
 Trefferlage: 8.36 mm links, 2.45 mm hoch  
 Streuwert: 8.54, horizontal: 8.57, vertikal: 8.51

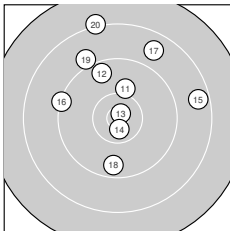

**Serie 2:**

10.1 ↑	9.6 ↘	10.8 *	10.6 *	8.6 →
9.3 ↖	8.7 ↗	9.6 ↓	9.0 ↘	8.2 ↑

beste Teiler: 128.9 (13.), 255.9 (14.), 705.8 (11.)  
 Trefferlage: 0.01 mm links, 6.40 mm hoch  
 Streuwert: 9.08, horizontal: 8.70, vertikal: 9.44

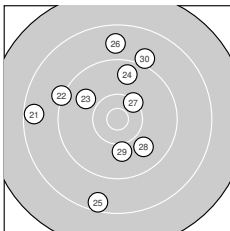

**Serie 3:**

8.5 ←	9.2 ↖	9.9 ↖	9.6 ↑	8.5 ↓
8.8 ↑	10.3 ↗	9.9 ↘	10.0 ↓	9.0 ↗

beste Teiler: 527.0 (27.), 754.7 (29.), 869.1 (23.)  
 Trefferlage: 2.54 mm links, 2.38 mm hoch  
 Streuwert: 9.79, horizontal: 8.46, vertikal: 10.97





Ergebnis: **267.6** (255)  
 Serien: 89.1 89.2 89.3  
 Zähler: 5 13 7 2 3 0 0 0 0 0  
 Innenzehner: 1  
 Weitesten: 3566 (22.), 3340 (11.), 3331 (1.)  
 beste Teiler: 420.9 (13.), 484.5 (16.), 601.7 (4.)  
 Trefferlage: 0.19 mm rechts, 2.46 mm hoch  
 Streuwert: 12.92, horizontal: 7.51, vertikal: 16.65

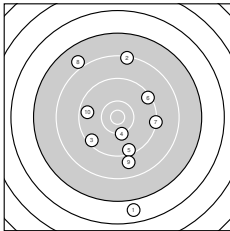
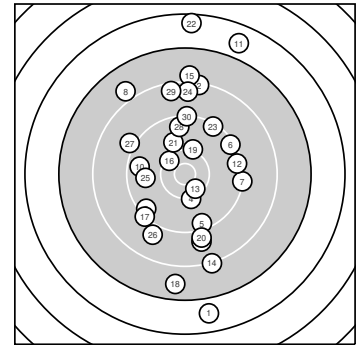

**Serie 1:**

6.8 ↓	8.3 ↑	9.4 ↙	10.2 ↓	9.4 ↓
9.4 ↗	9.2 →	7.9 ↘	8.9 ↓	9.6 ←

beste Teiler: 601.7 (4.), 1083.7 (10.), 1224.1 (5.)  
 Trefferlage: 0.87 mm rechts, 2.67 mm tief  
 Streuwert: 13.19, horizontal: 9.20, vertikal: 16.24

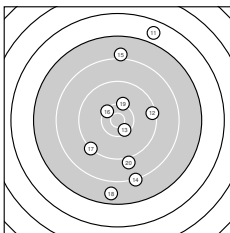

**Serie 2:**

6.8 ↗	9.4 →	10.4 *	8.2 ↓	8.0 ↑
10.3 ↘	9.2 ↙	7.7 ↓	10.2 ↑	9.0 ↓

beste Teiler: 420.9 (13.), 484.5 (16.), 613.2 (19.)  
 Trefferlage: 2.52 mm rechts, 0.97 mm tief  
 Streuwert: 13.76, horizontal: 6.87, vertikal: 18.21

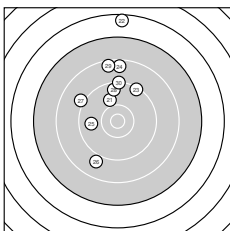

**Serie 3:**

10.0 ↖	6.5 ↑	9.3 ↗	8.5 ↑	9.8 ←
8.9 ↙	9.1 ↘	9.5 ↑	8.5 ↑	9.2 ↑

beste Teiler: 797.2 (21.), 935.1 (25.), 1122.0 (28.)  
 Trefferlage: 2.80 mm links, 11.03 mm hoch  
 Streuwert: 10.19, horizontal: 5.80, vertikal: 13.19



**Ergebnis: 277.5 (263)**  
**Serien: 92.3 90.2 95.0**  
**Zähler: 7 13 6 4 0 0 0 0 0 0**  
**Innenzehner: 0**  
**Weiteste: 2974 (11.), 2539 (27.), 2537 (4.)**  
**beste Teiler: 531.5 (30.), 536.1 (15.), 597.3 (8.)**  
**Trefferlage: 3.47 mm links, 0.54 mm tief**  
**Streuwert: 10.69, horizontal: 6.76, vertikal: 13.52**

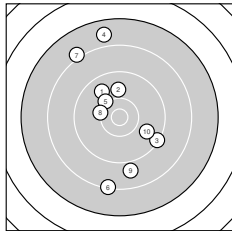
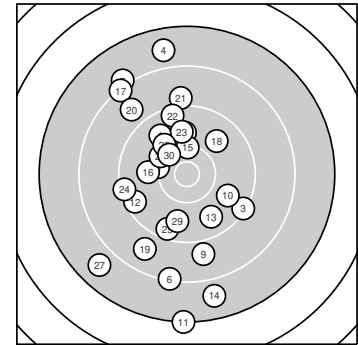

**Serie 1:**  
 9.8 ↘                      9.9 ↑                      9.3 ↘                      7.8 ↑                      10.2 ↘  
 8.3 ↓                      8.1 ↘                      10.2 ←                      8.9 ↓                      9.8 ↘  
**beste Teiler: 597.3 (8.), 640.9 (5.), 834.9 (2.)**  
**Trefferlage: 1.41 mm links, 1.76 mm hoch**  
**Streuwert: 11.40, horizontal: 7.22, vertikal: 14.42**

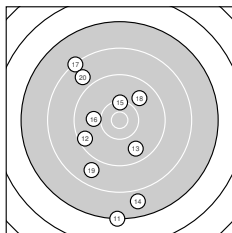

**Serie 2:**  
 7.2 ↓                      9.5 ↙                      9.7 ↘                      7.8 ↓                      10.3 ↑  
 10.0 ←                      8.3 ↘                      9.8 ↗                      8.8 ↙                      8.8 ↘  
**beste Teiler: 536.1 (15.), 783.9 (16.), 895.0 (18.)**  
**Trefferlage: 3.54 mm links, 4.11 mm tief**  
**Streuwert: 12.20, horizontal: 7.52, vertikal: 15.53**

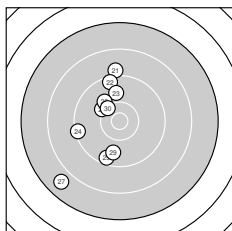

**Serie 3:**  
 9.0 ↑                      9.4 ↑                      9.9 ↑                      9.3 ←                      9.5 ↓  
 10.1 ↘                      7.8 ↙                      10.0 ↘                      9.7 ↓                      10.3 ↘  
**beste Teiler: 531.5 (30.), 642.3 (26.), 745.8 (28.)**  
**Trefferlage: 5.47 mm links, 0.72 mm hoch**  
**Streuwert: 8.57, horizontal: 5.39, vertikal: 10.85**



**Ergebnis: 279.1 (266)**  
**Serien: 90.8 96.5 91.8**  
**Zähler: 10 13 2 3 2 0 0 0 0 0**  
**Innenzehner: 4**  
**Weiteste: 3833 (2.), 3300 (8.), 3062 (13.)**  
**beste Teiler: 182.9 (5.), 198.6 (1.), 439.2 (21.)**  
**Trefferlage: 1.04 mm rechts, 4.80 mm tief**  
**Streuwert: 11.03, horizontal: 9.02, vertikal: 12.72**

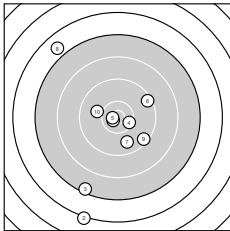
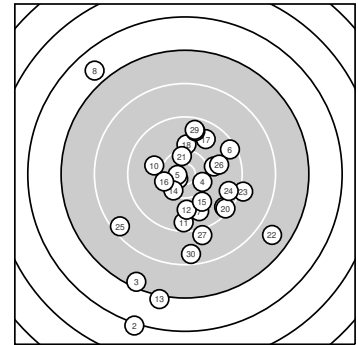

**Serie 1:**

10.7 *	6.2 ↓	7.4 ↓	10.4 *	10.7 *
9.4 ↗	9.8 ↓	6.8 ↘	9.4 ↘	10.0 ←

**beste Teiler: 182.9 (5.), 198.6 (1.), 457.9 (4.)**  
**Trefferlage: 2.85 mm links, 4.93 mm tief**  
**Streuwert: 13.98, horizontal: 10.37, vertikal: 16.84**

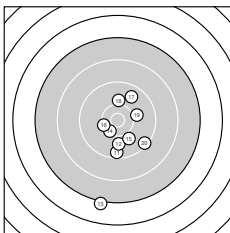

**Serie 2:**

9.5 ↓	9.9 ↓	7.1 ↓	10.4 ↙	10.0 ↘
10.3 ←	9.7 ↗	10.1 ↑	10.1 →	9.4 ↘

**beste Teiler: 480.5 (14.), 530.0 (16.), 713.9 (18.)**  
**Trefferlage: 1.23 mm rechts, 5.32 mm tief**  
**Streuwert: 8.56, horizontal: 5.16, vertikal: 10.95**

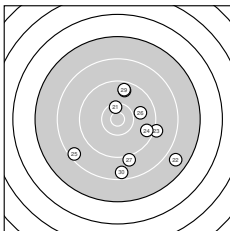

**Serie 3:**

10.4 *	7.8 ↘	9.1 ↘	9.5 ↘	8.4 ↙
9.9 →	9.0 ↓	9.6 ↑	9.6 ↑	8.5 ↓

**beste Teiler: 439.2 (21.), 852.3 (26.), 1060.6 (28.)**  
**Trefferlage: 4.77 mm rechts, 4.16 mm tief**  
**Streuwert: 10.32, horizontal: 9.77, vertikal: 10.83**



Ergebnis: **257.9** (244)  
 Serien: 89.3 87.4 81.2  
 Zähler: 4 11 7 4 1 3 0 0 0 0  
 Innenzehner: 1  
 Weitestе: 4355 (29.), 4228 (17.), 4193 (11.)  
 beste Teiler: 445.5 (26.), 491.2 (16.), 537.4 (7.)  
 Trefferlage: 6.56 mm links, 6.95 mm tief  
 Streuwert: 14.03, horizontal: 12.34, vertikal: 15.54

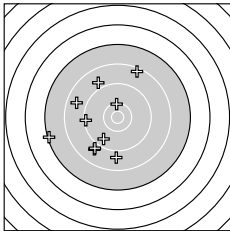
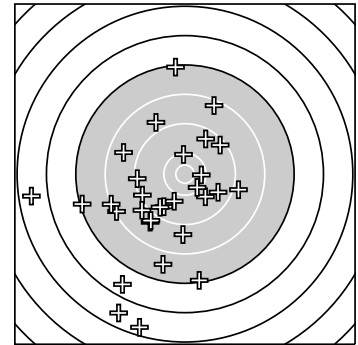

**Serie 1:**

8.9 ↙	8.4 ↗	9.0 ↘	7.3 ←	8.9 ↓
8.7 ↖	10.3 ↑	8.9 ↘	9.3 ←	9.6 ↙

beste Teiler: 537.4 (7.), 1057.3 (10.), 1306.9 (9.)  
 Trefferlage: 8.32 mm links, 1.64 mm tief  
 Streuwert: 11.08, horizontal: 9.87, vertikal: 12.18

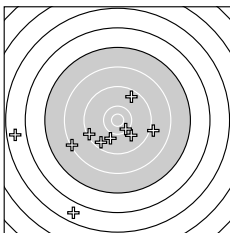

**Serie 2:**

5.7 ↙	9.9 ↘	9.5 ↘	9.1 →	8.3 ←
10.3 ↘	5.7 ←	10.0 ↘	9.6 ↗	9.3 ←

beste Teiler: 491.2 (16.), 795.3 (18.), 829.8 (12.)  
 Trefferlage: 7.08 mm links, 8.05 mm tief  
 Streuwert: 14.25, horizontal: 16.33, vertikal: 11.79

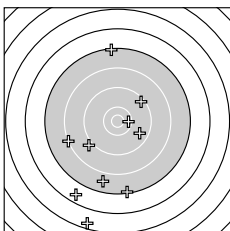

**Serie 3:**

7.3 ↓	9.4 ↗	7.3 ↑	8.2 ←	9.7 →
10.4 *	9.0 ↘	6.6 ↘	5.5 ↓	7.8 ↓

beste Teiler: 445.5 (26.), 1027.5 (25.), 1242.9 (22.)  
 Trefferlage: 4.29 mm links, 11.14 mm tief  
 Streuwert: 16.67, horizontal: 10.81, vertikal: 20.94



Ergebnis: **265.6** (251)  
 Serien: 88.4 94.4 82.8  
 Zähler: 7 11 4 3 4 1 0 0 0 0  
 Innenzehner: 2  
 Weitesten: 4211 (5.), 3624 (27.), 3420 (6.)  
 beste Teiler: 369.6 (26.), 369.8 (12.), 476.3 (19.)  
 Trefferlage: 2.50 mm links, 1.93 mm tief  
 Streuwert: 14.21, horizontal: 12.14, vertikal: 16.01

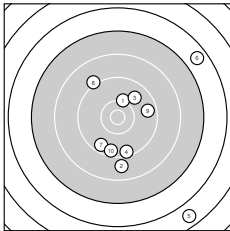
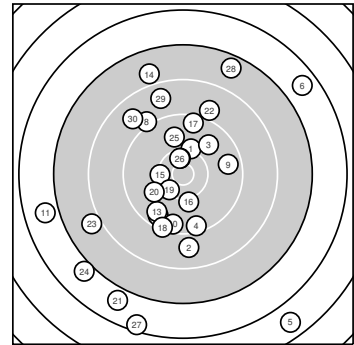

**Serie 1:**

10.2 ↑	8.8 ↓	9.8 ↗	9.4 ↓	5.7 ↘
6.7 ↗	9.6 ↘	9.1 ↘	9.6 →	9.5 ↓

beste Teiler: 610.6 (1.), 896.6 (3.), 1065.4 (9.)  
 Trefferlage: 5.83 mm rechts, 3.65 mm tief  
 Streuwert: 14.17, horizontal: 11.97, vertikal: 16.07

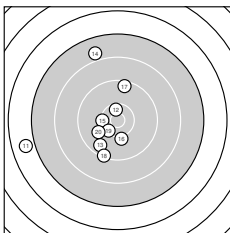

**Serie 2:**

6.8 ←	10.5 *	9.6 ↘	7.9 ↑	10.3 ←
10.1 ↓	9.5 ↑	9.3 ↘	10.4 ↘	10.0 ←

beste Teiler: 369.8 (12.), 476.3 (19.), 528.0 (15.)  
 Trefferlage: 6.20 mm links, 0.54 mm tief  
 Streuwert: 10.22, horizontal: 9.58, vertikal: 10.82

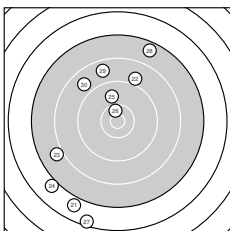

**Serie 3:**

6.9 ↘	9.0 ↑	8.0 ←	7.0 ↘	9.9 ↑
10.5 *	6.4 ↓	7.6 ↑	8.7 ↑	8.8 ↘

beste Teiler: 369.6 (26.), 875.6 (25.), 1587.4 (22.)  
 Trefferlage: 7.16 mm links, 1.61 mm tief  
 Streuwert: 16.86, horizontal: 11.09, vertikal: 21.10



Ergebnis: **292.6** (279)  
 Serien: 100.9 96.2 95.5  
 Zähler: 15 11 2 2 0 0 0 0 0 0  
 Innenzehner: 5  
 Weitester: 2994 (6.), 2482 (26.), 1862 (21.)  
 beste Teiler: 16.0 (22.), 58.4 (3.), 77.2 (7.)  
 Trefferlage: 0.51 mm rechts, 2.02 mm hoch  
 Streuwert: 8.23, horizontal: 4.03, vertikal: 10.93

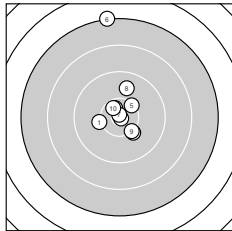
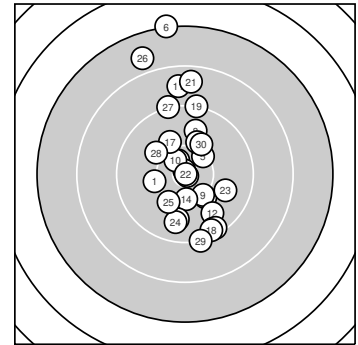

**Serie 1:**

10.2 ←	10.6 *	10.9 *	10.2 ↘	10.3 ↗
7.2 ↑	10.9 *	9.8 ↑	10.3 ↘	10.5 *

beste Teiler: 58.4 (3.), 77.2 (7.), 307.2 (2.)  
 Trefferlage: 0.06 mm rechts, 3.77 mm hoch  
 Streuwert: 7.42, horizontal: 3.42, vertikal: 9.93

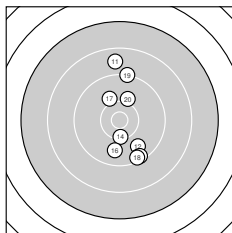

**Serie 2:**

8.7 ↑	9.8 ↘	9.4 ↘	10.3 ↓	9.4 ↘
9.8 ↓	10.1 ↖	9.4 ↘	9.2 ↑	10.1 ↑

beste Teiler: 503.6 (14.), 687.1 (20.), 714.9 (17.)  
 Trefferlage: 2.17 mm rechts, 1.07 mm tief  
 Streuwert: 8.20, horizontal: 3.41, vertikal: 11.08

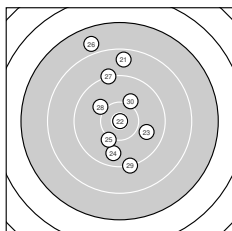

**Serie 3:**

8.6 ↑	10.9 *	9.9 ↘	9.7 ↓	10.1 ↗
7.8 ↖	9.2 ↑	10.0 ↖	9.2 ↓	10.1 ↗

beste Teiler: 16.0 (22.), 649.1 (25.), 684.7 (30.)  
 Trefferlage: 0.69 mm links, 3.38 mm hoch  
 Streuwert: 9.26, horizontal: 4.90, vertikal: 12.14



**Ergebnis: 278.1 (265)**  
**Serien: 94.2 91.4 92.5**  
**Zähler: 8 12 8 1 1 0 0 0 0 0**  
**Innenzehner: 3**  
**Weiteste: 3209 (18.), 2782 (25.), 2341 (11.)**  
**beste Teiler: 170.5 (14.), 326.7 (27.), 372.2 (10.)**  
**Trefferlage: 3.40 mm links, 4.22 mm hoch**  
**Streuwert: 10.19, horizontal: 9.19, vertikal: 11.10**

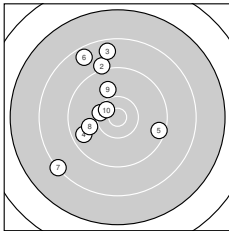
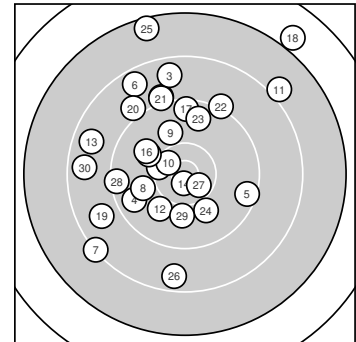

**Serie 1:**

10.3 ←	9.1 ↑	8.6 ↑	9.6 ←	9.4 →
8.6 ↘	8.3 ↙	9.9 ←	9.9 ↑	10.5 *

**beste Teiler: 372.2 (10.), 498.9 (1.), 811.8 (9.)**  
**Trefferlage: 4.92 mm links, 3.51 mm hoch**  
**Streuwert: 8.98, horizontal: 7.17, vertikal: 10.49**

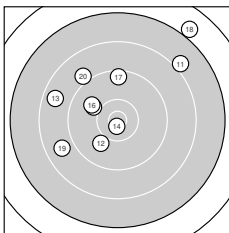

**Serie 2:**

8.0 ↗	10.0 ↙	8.7 ↖	10.7 *	10.0 ↖
9.9 ↘	9.4 ↑	6.9 ↗	8.8 ←	9.0 ↘

**beste Teiler: 170.5 (14.), 759.3 (15.), 791.0 (12.)**  
**Trefferlage: 2.33 mm links, 6.30 mm hoch**  
**Streuwert: 11.39, horizontal: 12.42, vertikal: 10.24**

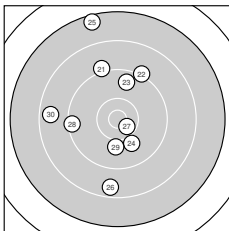

**Serie 3:**

9.1 ↑	9.2 ↗	9.6 ↑	10.0 ↘	7.5 ↑
8.6 ↓	10.5 *	9.4 ←	10.0 ↓	8.6 ←

**beste Teiler: 326.7 (27.), 768.8 (29.), 775.2 (24.)**  
**Trefferlage: 2.96 mm links, 2.84 mm hoch**  
**Streuwert: 10.87, horizontal: 7.90, vertikal: 13.20**



Ergebnis: **259.2** (247)  
 Serien: 89.5 83.1 86.6  
 Zähler: 1 12 10 7 0 0 0 0 0 0  
 Innenzehner: 0  
 Weitesten: 3081 (12.), 2995 (16.), 2974 (30.)  
 beste Teiler: 701.5 (17.), 829.5 (21.), 945.7 (18.)  
 Trefferlage: 1.11 mm links, 9.20 mm tief  
 Streuwert: 12.57, horizontal: 11.51, vertikal: 13.54

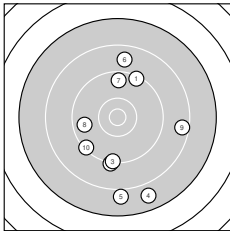
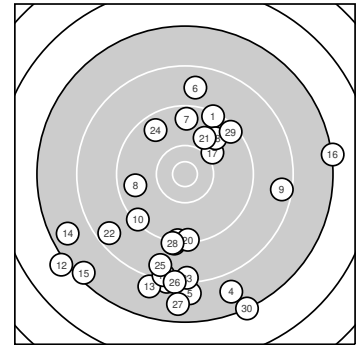

**Serie 1:**

9.3 ↗	9.2 ↓	9.3 ↓	7.8 ↓	8.0 ↓
8.8 ↑	9.6 ↑	9.7 ↖	8.5 →	9.3 ↙

beste Teiler: 1021.8 (8.), 1113.4 (7.), 1292.9 (1.)  
 Trefferlage: 1.47 mm rechts, 4.90 mm tief  
 Streuwert: 12.01, horizontal: 8.67, vertikal: 14.61

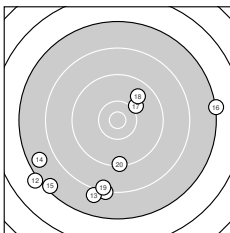

**Serie 2:**

8.2 ↓	7.1 ↖	8.0 ↓	7.6 ↖	7.4 ↙
7.2 →	10.1 ↗	9.8 ↗	8.4 ↓	9.3 ↓

beste Teiler: 701.5 (17.), 945.7 (18.), 1321.2 (20.)  
 Trefferlage: 4.20 mm links, 11.21 mm tief  
 Streuwert: 14.34, horizontal: 16.48, vertikal: 11.82

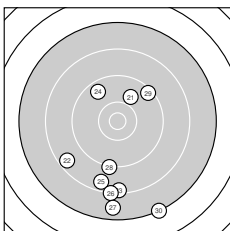

**Serie 3:**

9.9 ↗	8.5 ↖	8.3 ↓	9.6 ↘	8.6 ↓
8.2 ↓	7.7 ↓	9.2 ↓	9.4 ↗	7.2 ↘

beste Teiler: 829.5 (21.), 1065.0 (24.), 1252.5 (29.)  
 Trefferlage: 0.60 mm links, 11.48 mm tief  
 Streuwert: 11.59, horizontal: 7.86, vertikal: 14.39





Ergebnis: **283.7** (272)  
 Serien: 95.4 93.5 94.8  
 Zähler: 11 11 7 1 0 0 0 0 0 0  
 Innenzehner: 2  
 Weitestе: 2492 (22.), 2280 (19.), 2039 (27.)  
 beste Teiler: 118.8 (5.), 391.6 (14.), 503.0 (3.)  
 Trefferlage: 2.23 mm rechts, 0.73 mm tief  
 Streuwert: 9.41, horizontal: 7.35, vertikal: 11.09

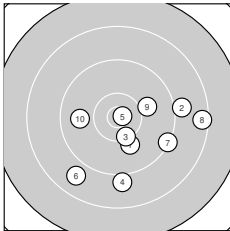
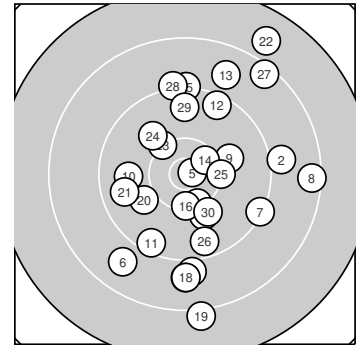

**Serie 1:**

10.0 ↘	9.0 →	10.3 ↘	9.0 ↓	10.8 *
8.8 ↗	9.3 ↘	8.4 →	10.0 →	9.8 ←

beste Teiler: 118.8 (5.), 503.0 (3.), 724.0 (1.)  
 Trefferlage: 4.31 mm rechts, 4.26 mm tief  
 Streuwert: 8.24, horizontal: 9.73, vertikal: 6.41

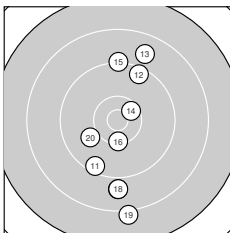

**Serie 2:**

9.4 ↘	9.4 ↗	8.8 ↗	10.5 *	9.2 ↑
10.3 ↓	8.9 ↓	8.9 ↓	8.1 ↓	10.0 ↙

beste Teiler: 391.6 (14.), 507.1 (16.), 772.9 (20.)  
 Trefferlage: 0.60 mm rechts, 3.27 mm tief  
 Streuwert: 10.11, horizontal: 4.14, vertikal: 13.69

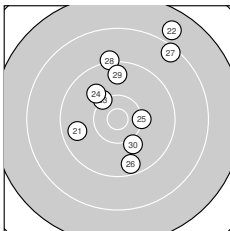

**Serie 3:**

9.7 ←	7.8 ↗	10.2 ↘	10.0 ↘	10.2 →
9.6 ↓	8.4 ↗	9.2 ↑	9.6 ↑	10.1 ↘

beste Teiler: 576.0 (25.), 586.6 (23.), 705.5 (30.)  
 Trefferlage: 1.79 mm rechts, 5.32 mm hoch  
 Streuwert: 8.96, horizontal: 7.38, vertikal: 10.30





**Ergebnis:** **308.4** (295)  
**Serien:** 103.5 101.7 103.2  
**Zähler:** 25 5 0 0 0 0 0 0 0  
**Innenzehner:** 21  
**Weiteste:** 387 (24.), 364 (25.), 294 (5.)  
**beste Teiler:** 38.0 (28.), 57.7 (22.), 78.4 (8.)  
**Trefferlage:** 0.43 mm links, 0.53 mm tief  
**Streuwert:** 1.27, horizontal: 1.25, vertikal: 1.29

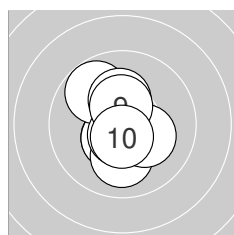
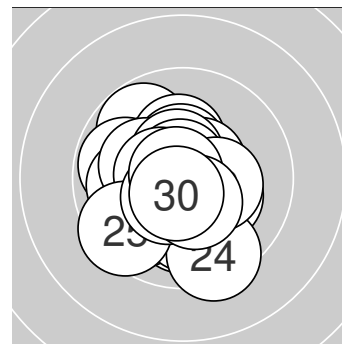

**Serie 1:**  
 10.5 \*                      10.5 \*                      10.6 \*  
 10.3 \*                      10.2 \*                      10.6 \*  
**beste Teiler:** 78.4 (8.), 89.1 (10.), 95.5 (3.)  
**Trefferlage:** 0.22 mm links, 0.23 mm tief  
**Streuwert:** 1.20, horizontal: 0.86, vertikal: 1.46

10.0 ↓                      9.8 ↘  
 10.4 \*                      10.6 \*

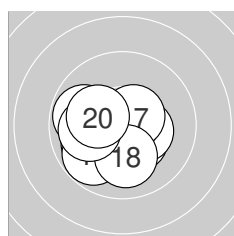

**Serie 2:**  
 9.8 ←                      10.4 \*                      10.4 \*  
 9.8 ↙                      10.6 \*                      10.1 ↓  
**beste Teiler:** 100.1 (17.), 144.3 (12.), 144.9 (15.)  
**Trefferlage:** 0.86 mm links, 0.65 mm tief  
**Streuwert:** 1.34, horizontal: 1.56, vertikal: 1.06

10.0 ↙                      10.4 \*  
 10.0 ←                      10.2 \*

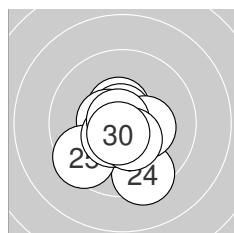

**Serie 3:**  
 10.5 \*                      10.7 \*                      10.5 \*  
 10.3 \*                      10.5 \*                      10.8 \*  
**beste Teiler:** 38.0 (28.), 57.7 (22.), 79.3 (30.)  
**Trefferlage:** 0.19 mm links, 0.71 mm tief  
**Streuwert:** 1.33, horizontal: 1.24, vertikal: 1.40

9.4 ↓                      9.5 ↙  
 10.4 \*                      10.6 \*



**Ergebnis:** 307.9 (294)  
**Serien:** 102.9 101.8 103.2  
**Zähler:** 24 6 0 0 0 0 0 0 0  
**Innenzehner:** 19  
**Weiteste:** 346 (7.), 288 (20.), 285 (15.)  
**beste Teiler:** 52.2 (2.), 55.3 (4.), 56.3 (24.)  
**Trefferlage:** 0.39 mm links, 0.29 mm tief  
**Streuwert:** 1.33, horizontal: 1.22, vertikal: 1.43

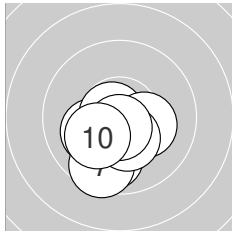
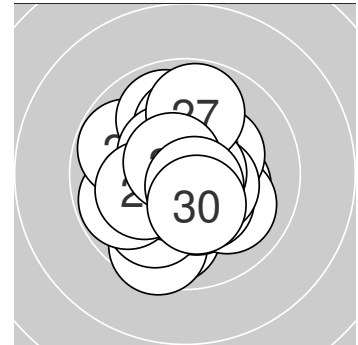

**Serie 1:**

10.5 *	10.7 *	10.1 ↙	10.7 *	9.8 ↓
10.3 *	9.6 ↓	10.3 *	10.7 *	10.2 *

**beste Teiler:** 52.2 (2.), 55.3 (4.), 70.0 (9.)  
**Trefferlage:** 0.41 mm links, 1.19 mm tief  
**Streuwert:** 1.04, horizontal: 1.04, vertikal: 1.05

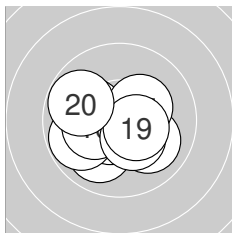

**Serie 2:**

10.1 ↖	10.0 ↘	10.0 ↙	10.6 *	9.8 ↙
10.3 *	10.3 *	10.4 *	10.5 *	9.8 ↖

**beste Teiler:** 100.8 (14.), 123.9 (19.), 149.0 (18.)  
**Trefferlage:** 0.55 mm links, 0.47 mm tief  
**Streuwert:** 1.44, horizontal: 1.74, vertikal: 1.05

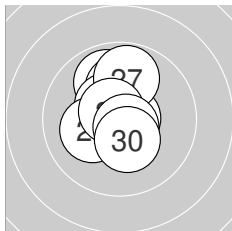

**Serie 3:**

9.9 ↖	10.3 *	10.1 ↑	10.7 *	10.5 *
10.2 *	9.8 ↑	10.6 *	10.7 *	10.4 *

**beste Teiler:** 56.3 (24.), 69.0 (29.), 77.7 (28.)  
**Trefferlage:** 0.23 mm links, 0.79 mm hoch  
**Streuwert:** 1.17, horizontal: 0.79, vertikal: 1.45



Ergebnis: **303.5** (291)  
 Serien: 100.8 100.6 102.1  
 Zähler: 21 9 0 0 0 0 0 0 0 0  
 Innenzehner: 14  
 Weitester: 439 (13.), 406 (6.), 344 (24.)  
 beste Teiler: 49.6 (26.), 79.8 (27.), 83.7 (30.)  
 Trefferlage: 0.64 mm links, 0.49 mm tief  
 Streuwert: 1.55, horizontal: 1.85, vertikal: 1.18

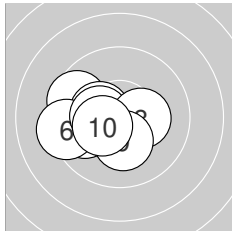
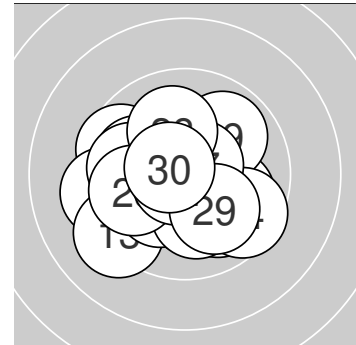

**Serie 1:**

9.9 ←	9.8 ←	10.5 *	9.6 ←	10.3 *
9.3 ←	10.4 *	10.3 *	10.3 *	10.4 *

beste Teiler: 111.4 (3.), 143.1 (10.), 148.2 (7.)  
 Trefferlage: 1.54 mm links, 0.28 mm tief  
 Streuwert: 1.36, horizontal: 1.69, vertikal: 0.90

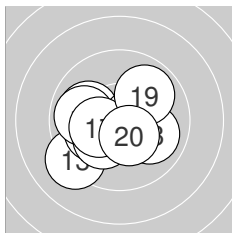

**Serie 2:**

10.0 ←	10.6 *	9.2 ↙	10.1 ←	9.9 ←
10.2 *	10.3 *	10.0 ↘	9.9 ↗	10.4 *

beste Teiler: 93.0 (12.), 135.1 (20.), 161.5 (17.)  
 Trefferlage: 0.71 mm links, 0.49 mm tief  
 Streuwert: 1.68, horizontal: 1.98, vertikal: 1.30

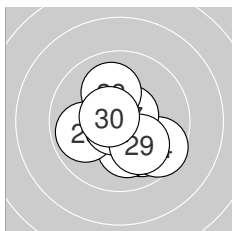

**Serie 3:**

10.0 ↘	10.4 *	10.1 ↓	9.6 ↘	9.9 ←
10.8 *	10.6 *	10.1 ↑	10.0 ↘	10.6 *

beste Teiler: 49.6 (26.), 79.8 (27.), 83.7 (30.)  
 Trefferlage: 0.33 mm rechts, 0.70 mm tief  
 Streuwert: 1.44, horizontal: 1.51, vertikal: 1.36



Ergebnis: **305.6** (293)  
 Serien: 102.0 101.5 102.1  
 Zähler: 23 7 0 0 0 0 0 0 0 0  
 Innenzehner: 16  
 Weitestе: 386 (15.), 327 (23.), 323 (3.)  
 beste Teiler: 38.8 (13.), 45.1 (24.), 98.0 (6.)  
 Trefferlage: 0.36 mm rechts, 0.45 mm tief  
 Streuwert: 1.44, horizontal: 1.52, vertikal: 1.36

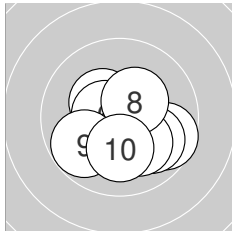
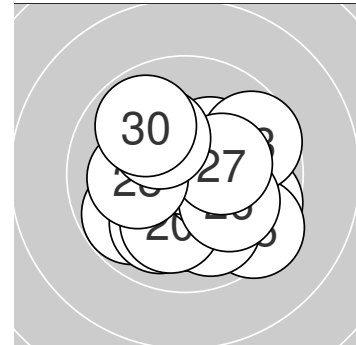

**Serie 1:**

10.5 *	10.5 *	9.7 ↘	10.4 *	9.9 ↘
10.6 *	10.1 ↘	10.4 *	9.8 ↙	10.1 ↓

beste Teiler: 98.0 (6.), 107.7 (1.), 113.7 (2.)  
 Trefferlage: 0.29 mm rechts, 0.81 mm tief  
 Streuwert: 1.39, horizontal: 1.59, vertikal: 1.15

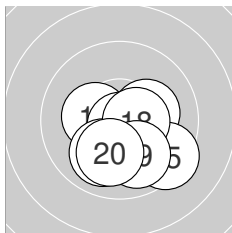

**Serie 2:**

10.3 *	10.2 *	10.8 *	10.0 ✓	9.4 ↘
10.1 ↘	10.2 *	10.5 *	9.9 ↘	10.1 ↓

beste Teiler: 38.8 (13.), 110.2 (18.), 164.0 (11.)  
 Trefferlage: 0.49 mm rechts, 1.24 mm tief  
 Streuwert: 1.29, horizontal: 1.40, vertikal: 1.17

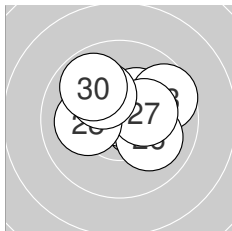

**Serie 3:**

10.5 *	10.3 *	9.6 ↗	10.8 *	10.4 *
10.0 ↘	10.3 *	10.1 ←	10.2 *	9.9 ↘

beste Teiler: 45.1 (24.), 116.5 (21.), 149.1 (25.)  
 Trefferlage: 0.29 mm rechts, 0.68 mm hoch  
 Streuwert: 1.41, horizontal: 1.72, vertikal: 1.00



**Ergebnis:** **310.8** (299)  
**Serien:** 102.0 104.4 104.4  
**Zähler:** 29 1 0 0 0 0 0 0 0 0  
**Innenzehner:** 23  
**Weiteste:** 297 (7.), 236 (9.), 230 (20.)  
**beste Teiler:** 24.1 (27.), 31.0 (28.), 48.7 (30.)  
**Trefferlage:** 0.46 mm rechts, 0.13 mm hoch  
**Streuwert:** 1.13, horizontal: 1.34, vertikal: 0.87

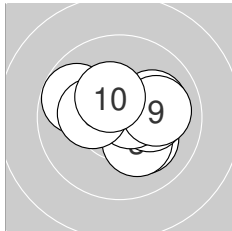
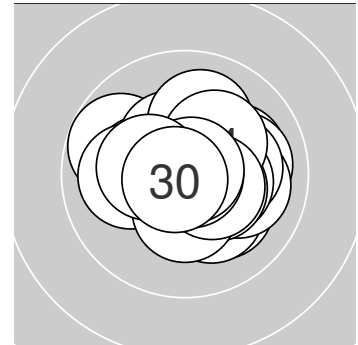

**Serie 1:**

10.1 ↘	10.2 *	10.2 *	10.2 *	10.1 →
10.7 *	9.8 ↙	10.3 *	10.0 →	10.4 *

**beste Teiler:** 74.0 (6.), 142.6 (10.), 173.8 (8.)  
**Trefferlage:** 0.64 mm rechts, 0.13 mm hoch  
**Streuwert:** 1.40, horizontal: 1.75, vertikal: 0.94

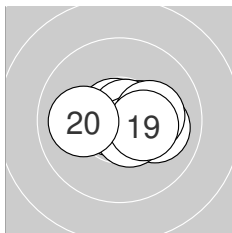

**Serie 2:**

10.7 *	10.5 *	10.7 *	10.0 →	10.7 *
10.7 *	10.6 *	10.2 *	10.3 *	10.0 ←

**beste Teiler:** 51.6 (16.), 53.0 (11.), 54.6 (15.)  
**Trefferlage:** 0.41 mm rechts, 0.00 mm  
**Streuwert:** 1.02, horizontal: 1.39, vertikal: 0.39

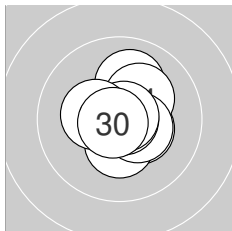

**Serie 3:**

10.4 *	10.2 *	10.0 ↑	10.2 *	10.4 *
10.4 *	10.9 *	10.8 *	10.3 *	10.8 *

**beste Teiler:** 24.1 (27.), 31.0 (28.), 48.7 (30.)  
**Trefferlage:** 0.35 mm rechts, 0.29 mm hoch  
**Streuwert:** 1.02, horizontal: 0.86, vertikal: 1.16



**Ergebnis:** **306.0** (295)  
**Serien:** 100.8 102.7 102.5  
**Zähler:** 25 5 0 0 0 0 0 0 0  
**Innenzehner:** 21  
**Weiteste:** 427 (4.), 406 (26.), 403 (8.)  
**beste Teiler:** 54.5 (21.), 61.6 (14.), 84.1 (16.)  
**Trefferlage:** 0.54 mm links, 0.42 mm tief  
**Streuwert:** 1.43, horizontal: 1.68, vertikal: 1.13

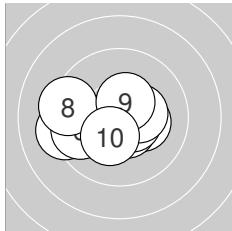
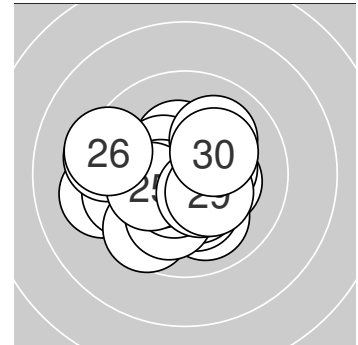

**Serie 1:**

10.1 ←	10.3 *	10.5 *	9.2 ←	10.5 *
9.7 ←	10.4 *	9.3 ←	10.5 *	10.3 *

**beste Teiler:** 101.6 (5.), 103.2 (3.), 124.4 (9.)  
**Trefferlage:** 0.89 mm links, 0.33 mm tief  
**Streuwert:** 1.70, horizontal: 2.24, vertikal: 0.85

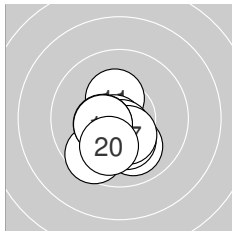

**Serie 2:**

10.3 *	10.0 ↘	9.6 ↙	10.7 *	10.3 *
10.6 *	10.4 *	10.4 *	10.4 *	10.0 ↙

**beste Teiler:** 61.6 (14.), 84.1 (16.), 135.4 (19.)  
**Trefferlage:** 0.37 mm links, 1.06 mm tief  
**Streuwert:** 1.10, horizontal: 0.96, vertikal: 1.22

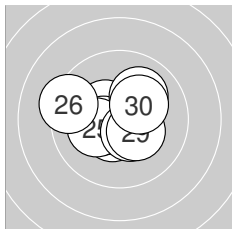

**Serie 3:**

10.7 *	10.4 *	10.5 *	10.4 *	10.2 *
9.3 ←	10.0 ↗	10.5 *	10.3 *	10.2 *

**beste Teiler:** 54.5 (21.), 113.6 (23.), 125.0 (28.)  
**Trefferlage:** 0.36 mm links, 0.13 mm hoch  
**Streuwert:** 1.42, horizontal: 1.71, vertikal: 1.04





**Ergebnis:** **304.7** (290)  
**Serien:** 101.3 101.2 102.2  
**Zähler:** 20 10 0 0 0 0 0 0 0  
**Innenzehner:** 18  
**Weiteste:** 395 (6.), 358 (25.), 351 (8.)  
**beste Teiler:** 57.8 (26.), 63.5 (14.), 72.0 (9.)  
**Trefferlage:** 0.67 mm links, 0.76 mm tief  
**Streuwert:** 1.44, horizontal: 1.57, vertikal: 1.30

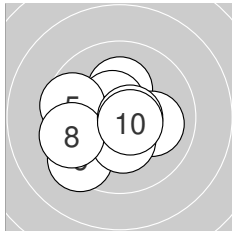
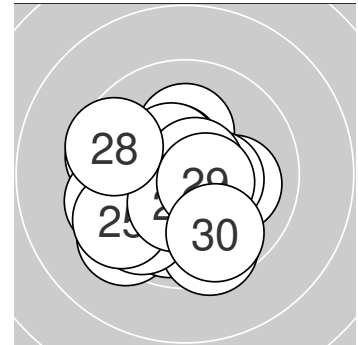

**Serie 1:**

10.2 *	10.5 *	10.1 →	10.4 *	9.6 ←
9.4 ↙	10.3 *	9.5 ↖	10.7 *	10.6 *

**beste Teiler:** 72.0 (9.), 80.9 (10.), 109.1 (2.)  
**Trefferlage:** 0.70 mm links, 0.36 mm tief  
**Streuwert:** 1.65, horizontal: 1.87, vertikal: 1.38

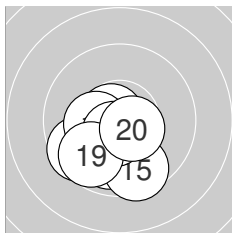

**Serie 2:**

10.1 ↙	10.3 *	9.9 ↓	10.7 *	9.6 ↓
9.6 ↙	10.3 *	10.5 *	9.7 ↙	10.5 *

**beste Teiler:** 63.5 (14.), 101.9 (18.), 103.7 (20.)  
**Trefferlage:** 0.90 mm links, 1.40 mm tief  
**Streuwert:** 1.17, horizontal: 1.23, vertikal: 1.12

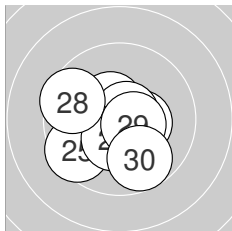

**Serie 3:**

10.6 *	10.5 *	10.4 *	10.3 *	9.5 ↙
10.7 *	10.4 *	9.6 ↖	10.5 *	9.7 ↓

**beste Teiler:** 57.8 (26.), 82.8 (21.), 101.5 (29.)  
**Trefferlage:** 0.41 mm links, 0.53 mm tief  
**Streuwert:** 1.48, horizontal: 1.66, vertikal: 1.26



**Ergebnis:** **302.6** (290)  
**Serien:** 99.2 101.8 101.6  
**Zähler:** 20 10 0 0 0 0 0 0 0 0  
**Innenzehner:** 16  
**Weiteste:** 458 (8.), 406 (10.), 381 (4.)  
**beste Teiler:** 45.0 (20.), 67.6 (2.), 74.0 (5.)  
**Trefferlage:** 0.04 mm links, 0.03 mm hoch  
**Streuwert:** 1.74, horizontal: 1.55, vertikal: 1.90

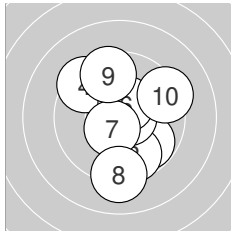
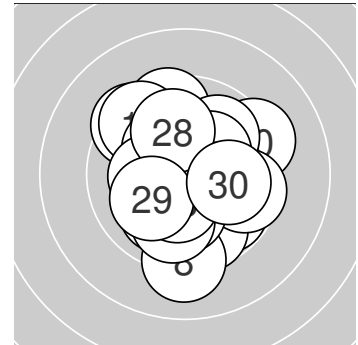

**Serie 1:**

9.8 ↘	10.7 *	9.7 ↓	9.4 ↘	10.7 *
10.5 *	10.5 *	9.1 ↓	9.5 ↑	9.3 ↗

**beste Teiler:** 67.6 (2.), 74.0 (5.), 108.1 (7.)  
**Trefferlage:** 0.35 mm rechts, 0.09 mm tief  
**Streuwert:** 2.18, horizontal: 1.76, vertikal: 2.52

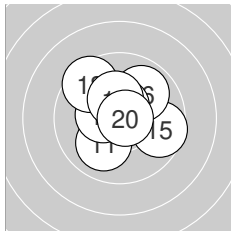

**Serie 2:**

10.0 ↙	10.4 *	10.3 *	10.4 *	9.6 →
9.9 ↗	10.6 *	9.5 ↘	10.3 *	10.8 *

**beste Teiler:** 45.0 (20.), 97.0 (17.), 130.3 (12.)  
**Trefferlage:** 0.17 mm links, 0.68 mm hoch  
**Streuwert:** 1.51, horizontal: 1.64, vertikal: 1.38

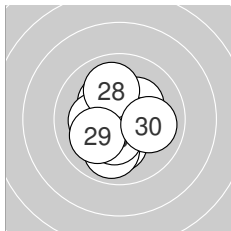

**Serie 3:**

10.3 *	10.2 *	10.2 *	9.9 ↓	10.2 *
10.4 *	10.3 *	10.0 ↑	10.1 ↙	10.0 →

**beste Teiler:** 146.8 (26.), 172.3 (27.), 174.5 (21.)  
**Trefferlage:** 0.33 mm links, 0.48 mm tief  
**Streuwert:** 1.47, horizontal: 1.30, vertikal: 1.62



**Ergebnis:** **303.5** (292)  
**Serien:** 102.6 100.2 100.7  
**Zähler:** 23 6 1 0 0 0 0 0 0 0  
**Innenzehner:** 16  
**Weiteste:** 531 (18.), 475 (27.), 433 (30.)  
**beste Teiler:** 22.8 (11.), 42.8 (14.), 57.2 (7.)  
**Trefferlage:** 0.26 mm rechts, 0.25 mm tief  
**Streuwert:** 1.72, horizontal: 2.14, vertikal: 1.16

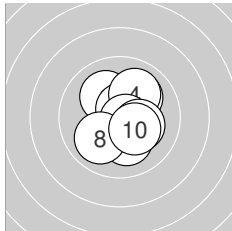
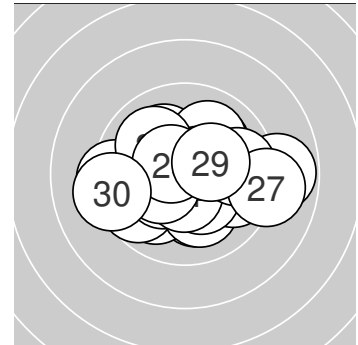

**Serie 1:**

10.0 ↗	10.1 ↘	10.7 *	10.0 ↗	10.5 *
10.1 ↘	10.7 *	10.0 ↗	10.2 *	10.3 *

**beste Teiler:** 57.2 (7.), 75.1 (3.), 107.5 (5.)  
**Trefferlage:** 0.43 mm rechts, 0.05 mm tief  
**Streuwert:** 1.32, horizontal: 1.13, vertikal: 1.50

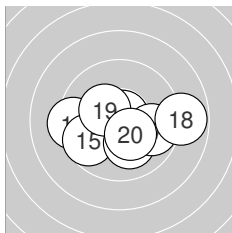

**Serie 2:**

10.9 *	9.3 ←	10.2 *	10.8 *	9.7 ↙
10.1 ↘	9.8 →	8.8 →	10.3 *	10.3 *

**beste Teiler:** 22.8 (11.), 42.8 (14.), 154.0 (20.)  
**Trefferlage:** 0.31 mm rechts, 0.65 mm tief  
**Streuwert:** 1.98, horizontal: 2.63, vertikal: 0.97

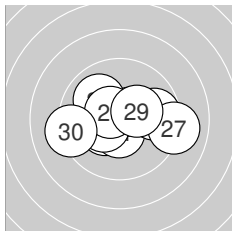

**Serie 3:**

10.3 *	10.6 *	10.0 ↘	10.5 *	9.7 →
10.4 *	9.1 →	10.6 *	10.3 *	9.2 ←

**beste Teiler:** 94.8 (22.), 99.4 (28.), 110.1 (24.)  
**Trefferlage:** 0.05 mm rechts, 0.05 mm tief  
**Streuwert:** 1.93, horizontal: 2.55, vertikal: 0.94



**Ergebnis:** 311.7 (299)  
**Serien:** 104.1 103.9 103.7  
**Zähler:** 29 1 0 0 0 0 0 0 0 0  
**Innenzehner:** 24  
**Weiteste:** 276 (12.), 242 (22.), 237 (7.)  
**beste Teiler:** 46.0 (18.), 48.3 (1.), 56.6 (19.)  
**Trefferlage:** 0.29 mm links, 0.06 mm tief  
**Streuwert:** 1.09, horizontal: 1.04, vertikal: 1.13

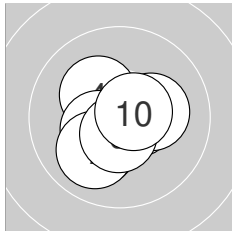
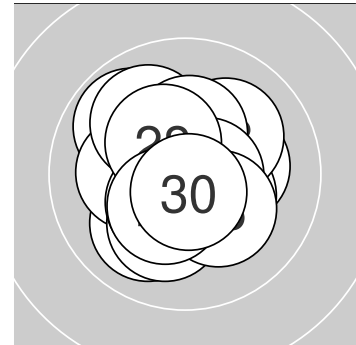

**Serie 1:**

10.8 *	10.6 *	10.1 ↙	10.2 *	10.6 *
10.4 *	10.0 ↘	10.2 *	10.6 *	10.6 *

**beste Teiler:** 48.3 (1.), 87.0 (10.), 91.0 (2.)  
**Trefferlage:** 0.28 mm links, 0.27 mm tief  
**Streuwert:** 1.07, horizontal: 1.13, vertikal: 1.02

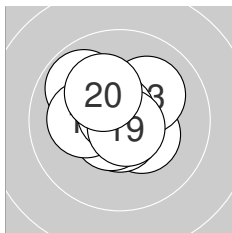

**Serie 2:**

10.3 *	9.8 ↘	10.1 ↗	10.6 *	10.6 *
10.6 *	10.2 *	10.8 *	10.7 *	10.2 *

**beste Teiler:** 46.0 (18.), 56.6 (19.), 76.0 (14.)  
**Trefferlage:** 0.33 mm links, 0.30 mm hoch  
**Streuwert:** 1.12, horizontal: 1.22, vertikal: 1.02

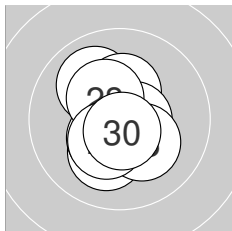

**Serie 3:**

10.1 ↙	10.0 ↘	10.3 *	10.4 *	10.6 *
10.2 *	10.6 *	10.4 *	10.4 *	10.7 *

**beste Teiler:** 70.4 (30.), 80.2 (25.), 89.1 (27.)  
**Trefferlage:** 0.26 mm links, 0.23 mm tief  
**Streuwert:** 1.13, horizontal: 0.84, vertikal: 1.35



Ergebnis: **308.6** (298)  
 Serien: 103.0 103.1 102.5  
 Zähler: 28 2 0 0 0 0 0 0 0  
 Innenzehner: 19  
 Weitesten: 321 (29.), 279 (26.), 246 (19.)  
 beste Teiler: 29.5 (20.), 47.0 (3.), 71.1 (2.)  
 Trefferlage: 0.05 mm links, 0.33 mm hoch  
 Streuwert: 1.28, horizontal: 1.42, vertikal: 1.12

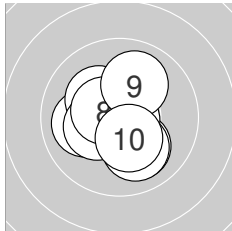
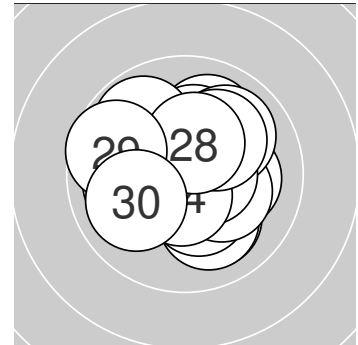

**Serie 1:**

10.1 ↘	10.7 *	10.8 *	10.1 ↘	10.0 ←
10.2 *	10.3 *	10.5 *	10.0 ↗	10.3 *

beste Teiler: 47.0 (3.), 71.1 (2.), 110.1 (8.)  
 Trefferlage: 0.26 mm links, 0.25 mm tief  
 Streuwert: 1.29, horizontal: 1.26, vertikal: 1.32

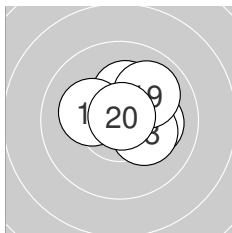

**Serie 2:**

10.5 *	10.4 *	10.5 *	10.2 *	10.2 *
10.1 →	10.2 *	10.2 *	10.0 ↗	10.8 *

beste Teiler: 29.5 (20.), 104.6 (11.), 120.9 (13.)  
 Trefferlage: 0.85 mm rechts, 0.62 mm hoch  
 Streuwert: 0.96, horizontal: 1.12, vertikal: 0.76

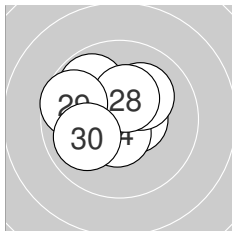

**Serie 3:**

10.6 *	10.7 *	10.6 *	10.6 *	10.0 ↘
9.8 ↘	10.1 ↗	10.4 *	9.7 ↖	10.0 ←

beste Teiler: 75.6 (22.), 95.1 (24.), 97.0 (23.)  
 Trefferlage: 0.76 mm links, 0.62 mm hoch  
 Streuwert: 1.28, horizontal: 1.46, vertikal: 1.06



**Ergebnis: 309.2 (299)**  
**Serien: 102.0 103.7 103.5**  
**Zähler: 29 1 0 0 0 0 0 0 0 0**  
**Innenzehner: 23**  
**Weiteste: 257 (25.), 250 (3.), 242 (1.)**  
**beste Teiler: 56.8 (24.), 92.6 (18.), 95.7 (29.)**  
**Trefferlage: 0.15 mm links, 0.44 mm tief**  
**Streuwert: 1.18, horizontal: 1.16, vertikal: 1.20**

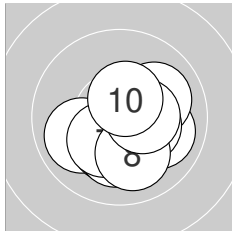
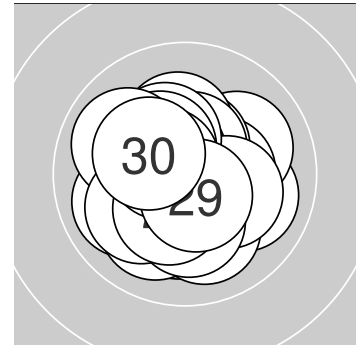

**Serie 1:**

10.0 ↗	10.0 ↗	10.0 ↖	10.3 *	10.2 *
10.3 *	10.3 *	10.0 ↓	10.4 *	10.5 *

**beste Teiler: 115.1 (10.), 137.1 (9.), 153.0 (6.)**  
**Trefferlage: 0.42 mm rechts, 0.72 mm tief**  
**Streuwert: 1.31, horizontal: 1.44, vertikal: 1.15**

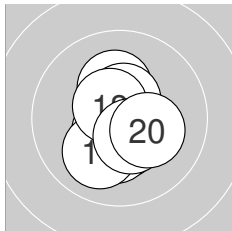

**Serie 2:**

10.5 *	10.4 *	10.2 *	10.6 *	10.5 *
10.3 *	10.0 ↙	10.6 *	10.4 *	10.2 *

**beste Teiler: 92.6 (18.), 97.4 (14.), 106.5 (15.)**  
**Trefferlage: 0.04 mm links, 0.51 mm tief**  
**Streuwert: 1.05, horizontal: 0.79, vertikal: 1.26**

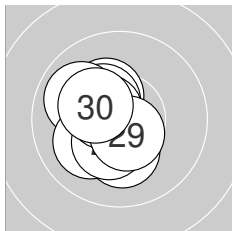

**Serie 3:**

10.3 *	10.2 *	10.4 *	10.7 *	9.9 ↖
10.1 ↙	10.4 *	10.6 *	10.6 *	10.3 *

**beste Teiler: 56.8 (24.), 95.7 (29.), 96.1 (28.)**  
**Trefferlage: 0.85 mm links, 0.08 mm tief**  
**Streuwert: 1.04, horizontal: 0.82, vertikal: 1.21**



Ergebnis: **300.5** (288)  
 Serien: 99.4 101.6 99.5  
 Zähler: 18 12 0 0 0 0 0 0 0  
 Innenzehner: 14  
 Weitest: 457 (8.), 427 (24.), 425 (25.)  
 beste Teiler: 27.4 (17.), 57.3 (15.), 58.4 (23.)  
 Trefferlage: 1.51 mm links, 0.21 mm tief  
 Streuwert: 1.55, horizontal: 1.86, vertikal: 1.17

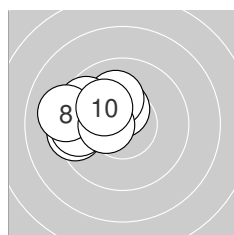
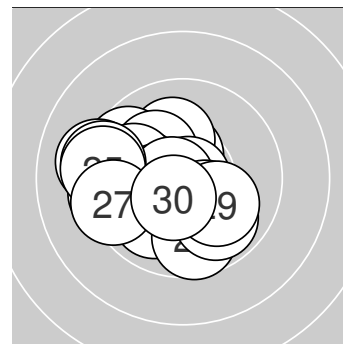

**Serie 1:**  
 10.5 \*                      10.2 \*                      10.3 \*                      9.4 ←                      10.1 ↑  
 9.6 ←                      9.6 ↖                      9.1 ←                      10.4 \*                      10.2 \*  
 beste Teiler: 119.4 (1.), 129.1 (9.), 170.6 (3.)  
 Trefferlage: 2.11 mm links, 0.75 mm hoch  
 Streuwert: 1.19, horizontal: 1.46, vertikal: 0.85

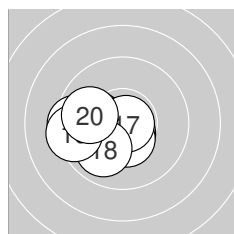

**Serie 2:**  
 9.5 ←                      10.6 \*                      10.1 ←                      10.2 \*                      10.7 \*  
 10.4 \*                      10.8 \*                      10.0 ↗                      9.4 ←                      9.9 ←  
 beste Teiler: 27.4 (17.), 57.3 (15.), 88.1 (12.)  
 Trefferlage: 1.50 mm links, 0.47 mm tief  
 Streuwert: 1.25, horizontal: 1.60, vertikal: 0.77

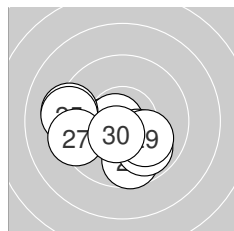

**Serie 3:**  
 9.7 ↓                      10.4 \*                      10.7 \*                      9.2 ←                      9.3 ←  
 10.3 \*                      9.4 ←                      9.9 ↘                      10.1 ↘                      10.5 \*  
 beste Teiler: 58.4 (23.), 115.3 (30.), 135.3 (22.)  
 Trefferlage: 0.92 mm links, 0.93 mm tief  
 Streuwert: 1.88, horizontal: 2.38, vertikal: 1.18



Ergebnis: **305.1** (290)  
 Serien: 101.0 102.2 101.9  
 Zähler: 20 10 0 0 0 0 0 0 0 0  
 Innenzehner: 15  
 Weitesten: 425 (7.), 372 (30.), 371 (27.)  
 beste Teiler: 25.9 (14.), 34.6 (29.), 46.5 (5.)  
 Trefferlage: 0.04 mm rechts, 0.78 mm hoch  
 Streuwert: 1.50, horizontal: 1.67, vertikal: 1.31

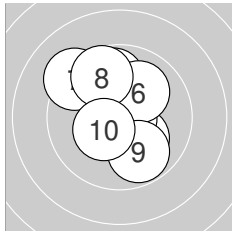
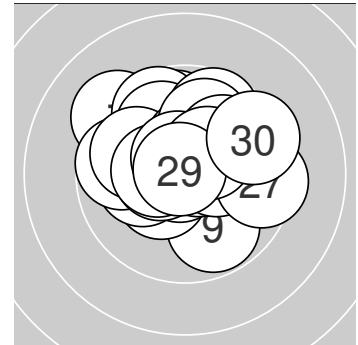

**Serie 1:**

9.8 ↑	10.4 *	10.1 ↘	10.7 *	10.8 *
10.0 ↗	9.3 ↙	9.7 ↘	9.8 ↘	10.4 *

beste Teiler: 46.5 (5.), 70.7 (4.), 138.1 (2.)  
 Trefferlage: 0.27 mm links, 0.69 mm hoch  
 Streuwert: 1.71, horizontal: 1.47, vertikal: 1.92

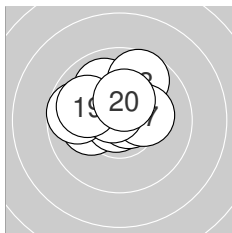

**Serie 2:**

10.1 ←	10.0 ↘	9.7 ↗	10.9 *	10.7 *
9.7 ←	10.2 *	10.6 *	9.9 ↙	10.4 *

beste Teiler: 25.9 (14.), 67.0 (15.), 78.8 (18.)  
 Trefferlage: 0.52 mm links, 0.89 mm hoch  
 Streuwert: 1.34, horizontal: 1.60, vertikal: 1.02

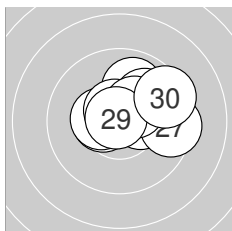

**Serie 3:**

10.3 *	10.5 *	10.4 *	9.9 ↗	10.6 *
10.0 ↗	9.5 →	10.4 *	10.8 *	9.5 ↗

beste Teiler: 34.6 (29.), 86.8 (25.), 119.0 (22.)  
 Trefferlage: 0.92 mm rechts, 0.77 mm hoch  
 Streuwert: 1.37, horizontal: 1.73, vertikal: 0.88





**Ergebnis:** **309.8** (300)  
**Serien:** 103.1 103.4 103.3  
**Zähler:** 30 0 0 0 0 0 0 0 0  
**Innenzehner:** 28  
**Weiteste:** 222 (15.), 212 (19.), 198 (22.)  
**beste Teiler:** 82.0 (3.), 95.2 (27.), 97.0 (2.)  
**Trefferlage:** 0.21 mm rechts, 0.01 mm tief  
**Streuwert:** 1.15, horizontal: 1.20, vertikal: 1.10

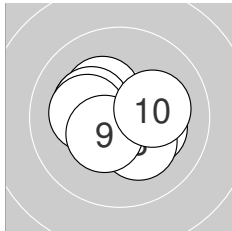
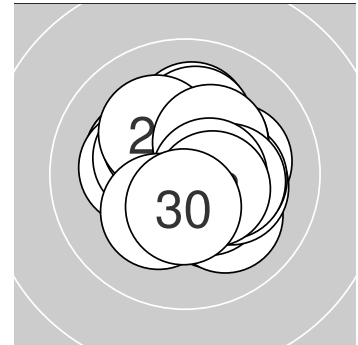

**Serie 1:**

10.3 *	10.6 *	10.6 *	10.2 *	10.2 *
10.2 *	10.2 *	10.2 *	10.4 *	10.2 *

**beste Teiler:** 82.0 (3.), 97.0 (2.), 130.9 (9.)  
**Trefferlage:** 0.32 mm links, 0.11 mm tief  
**Streuwert:** 1.18, horizontal: 1.41, vertikal: 0.90

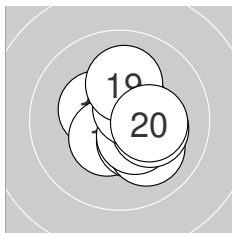

**Serie 2:**

10.4 *	10.5 *	10.4 *	10.4 *	10.1 ↘
10.4 *	10.2 *	10.6 *	10.1 ↑	10.3 *

**beste Teiler:** 99.0 (18.), 124.0 (12.), 127.9 (16.)  
**Trefferlage:** 0.67 mm rechts, 0.28 mm tief  
**Streuwert:** 1.08, horizontal: 1.02, vertikal: 1.13

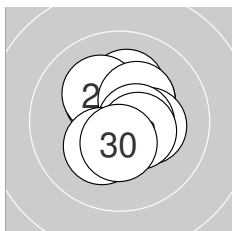

**Serie 3:**

10.3 *	10.2 *	10.2 *	10.3 *	10.3 *
10.3 *	10.6 *	10.5 *	10.2 *	10.4 *

**beste Teiler:** 95.2 (27.), 121.2 (28.), 127.1 (30.)  
**Trefferlage:** 0.29 mm rechts, 0.36 mm hoch  
**Streuwert:** 1.13, horizontal: 1.02, vertikal: 1.23



**Ergebnis:** **308.0** (295)  
**Serien:** 103.1 101.9 103.0  
**Zähler:** 25 5 0 0 0 0 0 0 0 0  
**Innenzehner:** 18  
**Weiteste:** 446 (2.), 370 (15.), 351 (18.)  
**beste Teiler:** 27.4 (16.), 40.0 (1.), 47.2 (6.)  
**Trefferlage:** 0.56 mm rechts, 0.38 mm tief  
**Streuwert:** 1.33, horizontal: 1.62, vertikal: 0.96

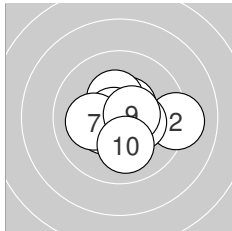
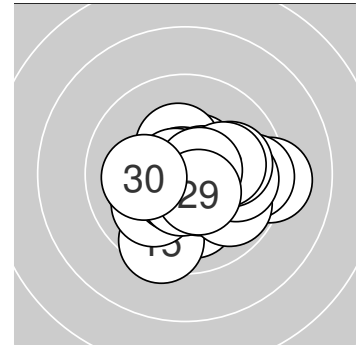

**Serie 1:**

10.8 *	9.2 →	10.5 *	10.3 *	10.4 *
10.8 *	10.1 ←	10.3 *	10.6 *	10.1 ↓

**beste Teiler:** 40.0 (1.), 47.2 (6.), 98.7 (9.)  
**Trefferlage:** 0.40 mm rechts, 0.15 mm tief  
**Streuwert:** 1.42, horizontal: 1.75, vertikal: 0.97

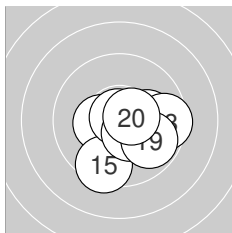

**Serie 2:**

10.4 *	10.4 *	10.1 →	10.4 *	9.5 ↓
10.8 *	10.4 *	9.5 →	9.8 ↘	10.6 *

**beste Teiler:** 27.4 (16.), 97.4 (20.), 127.2 (17.)  
**Trefferlage:** 0.92 mm rechts, 0.66 mm tief  
**Streuwert:** 1.37, horizontal: 1.56, vertikal: 1.16

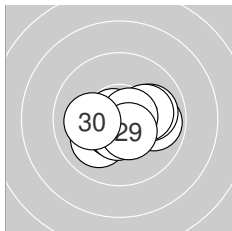

**Serie 3:**

9.9 →	10.0 →	10.7 *	10.0 ✓	10.6 *
10.1 →	10.5 *	10.6 *	10.5 *	10.1 ←

**beste Teiler:** 52.4 (23.), 79.8 (28.), 92.4 (25.)  
**Trefferlage:** 0.36 mm rechts, 0.33 mm tief  
**Streuwert:** 1.27, horizontal: 1.65, vertikal: 0.71



Ergebnis: **250.5** (237)  
 Serien: 84.6 83.6 84.3 0.0<sup>DSB 0.11.4.1</sup>  
 Zähler: 3 9 10 6 0 1 0 0 0 1  
 Innenzehner: 1  
 Weitester: 7616 (20.), 4603 (5.), 3194 (8.)  
 beste Teiler: 299.3 (4.), 688.0 (11.), 799.7 (27.)  
 Trefferlage: 9.04 mm links, 1.69 mm hoch  
 Streuwert: 16.34, horizontal: 18.78, vertikal: 13.46

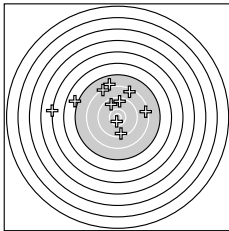
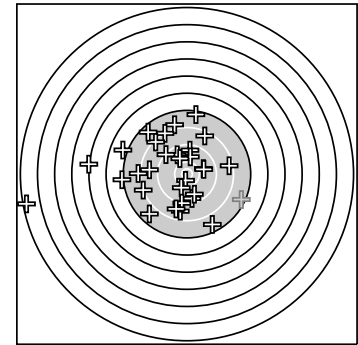

**Serie 1:**  
 9.5 ↑                      8.0 ↑                      9.5 ↓                      10.6 \*                      5.2 ←  
 8.5 ↗                      9.7 ↘                      7.0 ↖                      8.2 ↘                      8.4 →  
 beste Teiler: 299.3 (4.), 1011.5 (7.), 1126.6 (1.)  
 Trefferlage: 6.52 mm links, 8.56 mm hoch  
 Streuwert: 15.23, horizontal: 18.83, vertikal: 10.47

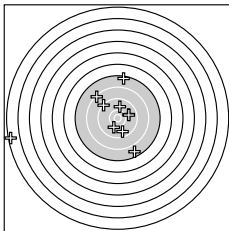

**Serie 2:**  
 10.1 ↘                      9.9 →                      7.4 ↑                      9.9 →                      7.7 ↓  
 8.3 ↘                      9.3 ↘                      9.9 ↑                      9.7 ↓                      1.4 ←  
 beste Teiler: 688.0 (11.), 809.2 (12.), 815.5 (14.)  
 Trefferlage: 6.54 mm links, 1.16 mm hoch  
 Streuwert: 20.82, horizontal: 25.36, vertikal: 14.97

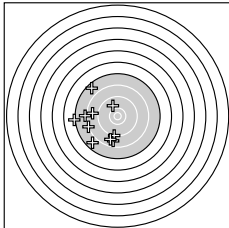

**Serie 3:**  
 7.1 ←                      8.2 ←                      8.8 ↓                      7.6 ↘                      8.1 ←  
 9.2 ↓                      10.0 ↘                      7.8 ↙                      8.8 ↓                      8.7 ←  
 beste Teiler: 799.7 (27.), 1375.2 (26.), 1701.3 (29.)  
 Trefferlage: 14.06 mm links, 4.65 mm tief  
 Streuwert: 11.18, horizontal: 9.85, vertikal: 12.37

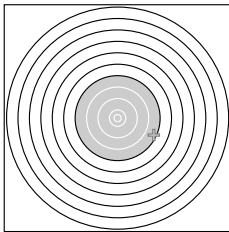

**Serie 4:**  
 0.0+ ↘<sup>AST, NSC</sup>  
 beste Teiler:  
 Trefferlage: 0.00 mm , 0.00 mm  
 Streuwert: 0.00, horizontal: 0.00, vertikal: 0.00

AST – Treffer wurde nach Ende der Schießzeit abgegeben  
 DSB 0.11.4.1 – Zu viele Schüsse im Wettkampf (-2)  
 NSC – Treffer wurde vermessen, geht aber nicht in die Wertung ein



Ergebnis: **260.7** (247)  
 Serien: 88.9 85.4 86.4  
 Zähler: 5 9 7 6 3 0 0 0 0 0  
 Innenzehner: 1  
 Weitesten: 3936 (12.), 3724 (1.), 3304 (25.)  
 beste Teiler: 95.1 (5.), 553.2 (10.), 593.6 (13.)  
 Trefferlage: 2.86 mm links, 3.90 mm hoch  
 Streuwert: 14.38, horizontal: 11.35, vertikal: 16.88

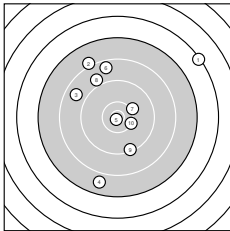
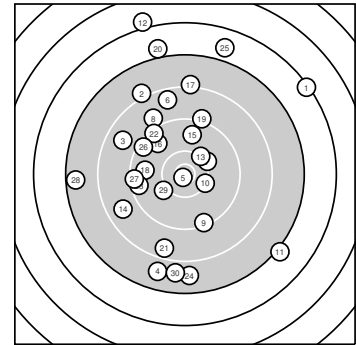

**Serie 1:**

6.3 ↗	8.1 ↘	8.7 ↘	7.8 ↓	10.8 *
8.6 ↑	10.1 ↗	8.9 ↘	9.3 ↓	10.3 ↘

beste Teiler: 95.1 (5.), 553.2 (10.), 642.7 (7.)  
 Trefferlage: 0.02 mm links, 4.65 mm hoch  
 Streuwert: 13.94, horizontal: 12.83, vertikal: 14.97

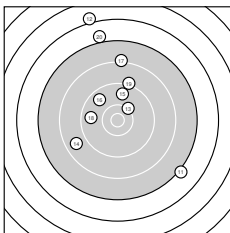

**Serie 2:**

7.1 ↘	6.0 ↑	10.2 ↗	8.7 ↖	9.7 ↑
9.7 ↘	8.2 ↑	9.7 ←	9.1 ↑	7.0 ↑

beste Teiler: 593.6 (13.), 998.3 (15.), 1000.8 (18.)  
 Trefferlage: 1.44 mm links, 10.01 mm hoch  
 Streuwert: 14.62, horizontal: 11.15, vertikal: 17.41

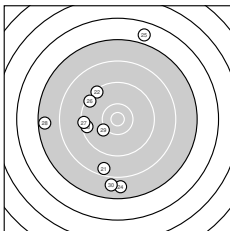

**Serie 3:**

8.6 ↓	9.4 ↘	9.5 ←	7.8 ↓	6.8 ↑
9.4 ↘	9.4 ←	7.5 ←	10.1 ↖	7.9 ↓

beste Teiler: 670.4 (29.), 1179.7 (23.), 1237.0 (26.)  
 Trefferlage: 7.12 mm links, 2.94 mm tief  
 Streuwert: 13.99, horizontal: 9.74, vertikal: 17.21



Ergebnis: **296.7** (284)  
 Serien: 102.1 97.7 96.9  
 Zähler: 17 10 3 0 0 0 0 0 0 0  
 Innenzehner: 11  
 Weitestе: 2274 (23.), 1934 (19.), 1879 (20.)  
 beste Teiler: 139.7 (6.), 197.2 (27.), 223.6 (15.)  
 Trefferlage: 0.59 mm rechts, 0.91 mm tief  
 Streuwert: 7.27, horizontal: 3.42, vertikal: 9.69

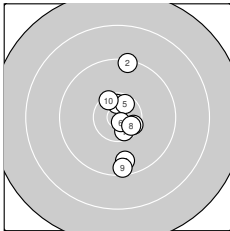
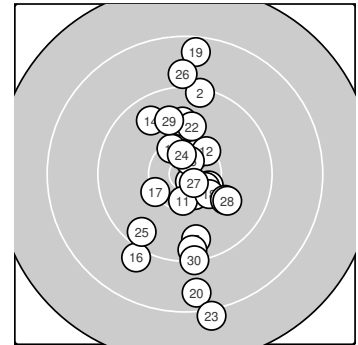

**Serie 1:**

10.5 *	9.3 ↑	10.4 *	10.6 *	10.5 *
10.8 *	9.6 ↓	10.5 *	9.5 ↓	10.4 *

beste Teiler: 139.7 (6.), 317.5 (4.), 358.0 (5.)  
 Trefferlage: 1.39 mm rechts, 0.73 mm tief  
 Streuwert: 5.21, horizontal: 1.68, vertikal: 7.18

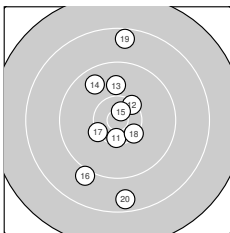

**Serie 2:**

10.4 *	10.3 ↗	9.9 ↑	9.7 ↘	10.7 *
9.0 ↙	10.3 ↖	10.3 ↘	8.5 ↑	8.6 ↓

beste Teiler: 223.6 (15.), 422.1 (11.), 494.6 (12.)  
 Trefferlage: 0.69 mm links, 0.02 mm tief  
 Streuwert: 8.26, horizontal: 3.93, vertikal: 11.00

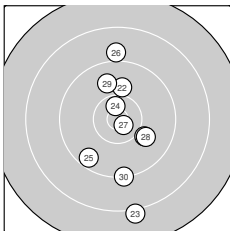

**Serie 3:**

10.0 ↘	10.0 ↑	8.1 ↓	10.6 *	9.5 ↙
9.0 ↑	10.7 *	10.0 ↘	9.8 ↑	9.2 ↓

beste Teiler: 197.2 (27.), 313.0 (24.), 749.7 (21.)  
 Trefferlage: 1.09 mm rechts, 1.97 mm tief  
 Streuwert: 8.50, horizontal: 4.06, vertikal: 11.31



**Ergebnis: 296.0 (283)**  
**Serien: 98.9 101.7 95.4**  
**Zähler: 15 13 2 0 0 0 0 0 0 0**  
**Innenzehner: 8**  
**Weiteste: 2089 (1.), 1690 (23.), 1413 (29.)**  
**beste Teiler: 95.8 (5.), 300.5 (17.), 304.1 (11.)**  
**Trefferlage: 1.51 mm links, 2.33 mm hoch**  
**Streuwert: 6.77, horizontal: 6.51, vertikal: 7.01**

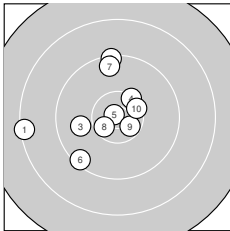
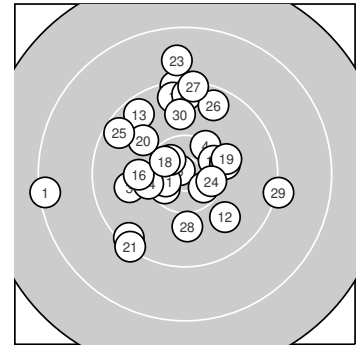

**Serie 1:**

8.3 ←                      9.3 ↑                      9.9 ←  
 9.4 ↙                      9.5 ↑                      10.5 \*

10.3 ↗                      10.8 \*  
 10.5 \*                      10.4 \*

**beste Teiler: 95.8 (5.), 339.6 (9.), 367.1 (8.)**  
**Trefferlage: 3.41 mm links, 1.29 mm hoch**  
**Streuwert: 7.12, horizontal: 7.45, vertikal: 6.78**

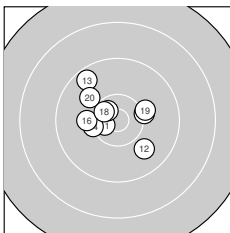

**Serie 2:**

10.6 \*                      9.9 ↘                      9.5 ↘  
 10.1 ←                      10.6 \*                      10.5 \*

10.2 ←                      10.2 →  
 10.1 →                      10.0 ↘

**beste Teiler: 300.5 (17.), 304.1 (11.), 353.1 (18.)**  
**Trefferlage: 1.52 mm links, 1.26 mm hoch**  
**Streuwert: 4.80, horizontal: 5.45, vertikal: 4.05**

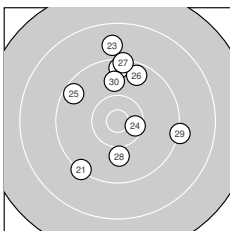

**Serie 3:**

9.3 ↙                      9.5 ↑                      8.8 ↑  
 9.6 ↗                      9.3 ↑                      10.0 ↓

10.4 \*                      9.5 ↘  
 9.2 →                      9.8 ↑

**beste Teiler: 404.8 (24.), 777.7 (28.), 889.9 (30.)**  
**Trefferlage: 0.40 mm rechts, 4.45 mm hoch**  
**Streuwert: 8.12, horizontal: 6.57, vertikal: 9.42**



**Ergebnis: 291.0 (278)**  
**Serien: 95.1 97.6 98.3**  
**Zähler: 13 12 5 0 0 0 0 0 0 0**  
**Innenzehner: 5**  
**Weiteste: 2305 (13.), 2209 (2.), 1830 (7.)**  
**beste Teiler: 246.0 (19.), 343.9 (15.), 360.1 (8.)**  
**Trefferlage: 0.39 mm links, 1.15 mm hoch**  
**Streuwert: 8.10, horizontal: 7.44, vertikal: 8.72**

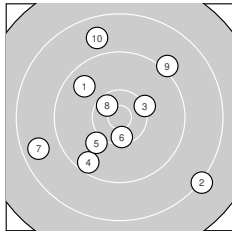
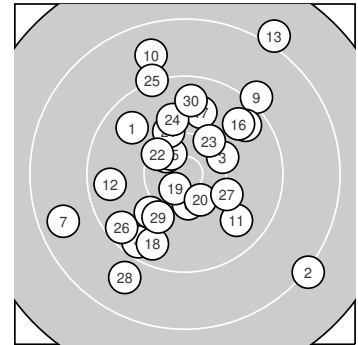

**Serie 1:**

9.7 ↘	8.2 ↘	10.2 ↗	9.5 ↙	10.0 ↙
10.4 *	8.7 ←	10.5 *	9.1 ↗	8.8 ↑

**beste Teiler: 360.1 (8.), 418.5 (6.), 579.6 (3.)**  
**Trefferlage: 1.02 mm links, 0.05 mm tief**  
**Streuwert: 9.65, horizontal: 9.78, vertikal: 9.53**

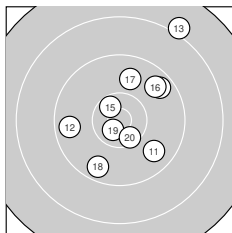

**Serie 2:**

9.7 ↘	9.6 ←	8.1 ↗	9.6 ↗	10.5 *
9.7 ↗	9.8 ↑	9.6 ↙	10.6 *	10.4 *

**beste Teiler: 246.0 (19.), 343.9 (15.), 421.2 (20.)**  
**Trefferlage: 2.17 mm rechts, 2.14 mm hoch**  
**Streuwert: 7.82, horizontal: 6.97, vertikal: 8.60**

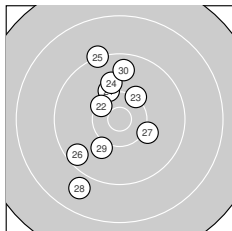

**Serie 3:**

10.2 ↑	10.4 ↘	10.2 ↗	10.0 ↑	9.2 ↑
9.5 ↙	10.1 ↘	8.9 ↙	10.1 ↙	9.7 ↑

**beste Teiler: 476.2 (22.), 578.2 (23.), 638.1 (21.)**  
**Trefferlage: 2.34 mm links, 1.37 mm hoch**  
**Streuwert: 7.05, horizontal: 4.72, vertikal: 8.79**



**Ergebnis: 289.9 (276)**  
**Serien: 90.6 100.6 98.7**  
**Zähler: 14 10 5 0 1 0 0 0 0 0**  
**Innenzehner: 5**  
**Weiteste: 3395 (4.), 2290 (6.), 1842 (1.)**  
**beste Teiler: 74.3 (16.), 237.7 (9.), 246.6 (10.)**  
**Trefferlage: 4.99 mm links, 0.51 mm hoch**  
**Streuwert: 8.20, horizontal: 6.25, vertikal: 9.76**

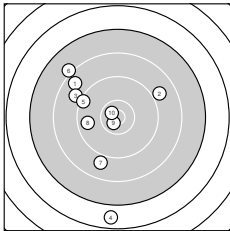
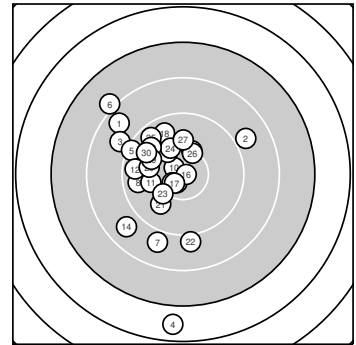

**Serie 1:**

8.6 ↘	8.9 ↗	9.0 ↖	6.7 ↓	9.4 ↖
8.1 ↘	8.9 ↓	9.7 ←	10.7 *	10.6 *

**beste Teiler: 237.7 (9.), 246.6 (10.), 1029.4 (8.)**  
**Trefferlage: 6.40 mm links, 0.34 mm tief**  
**Streuwert: 12.20, horizontal: 9.15, vertikal: 14.62**

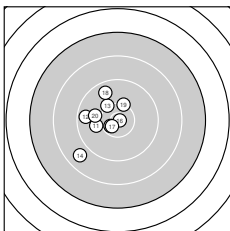

**Serie 2:**

10.0 ←	9.6 ←	10.2 ↘	8.8 ↗	10.6 *
10.9 *	10.6 *	9.7 ↗	10.2 ↑	10.0 ←

**beste Teiler: 74.3 (16.), 278.7 (17.), 309.5 (15.)**  
**Trefferlage: 4.76 mm links, 0.44 mm hoch**  
**Streuwert: 5.26, horizontal: 4.79, vertikal: 5.70**

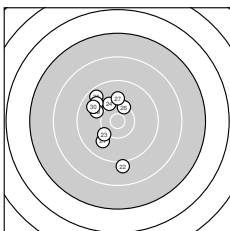

**Serie 3:**

9.9 ↗	9.0 ↓	10.2 ↗	10.1 ↗	9.6 ↘
10.3 ↑	10.0 ↑	9.8 ↘	10.0 ↖	9.8 ↘

**beste Teiler: 517.3 (26.), 633.6 (23.), 650.3 (24.)**  
**Trefferlage: 3.81 mm links, 1.43 mm hoch**  
**Streuwert: 6.10, horizontal: 3.91, vertikal: 7.69**





# LP Auflage 30 – Wertung –Senioren II männl.

StandNr: 68

Wetter, Roger #833

StartNr: 1044

7. Mai 2022 12:05

6000 KUS Kreuztal e.V.

Ergebnis: **294.1** (281)  
 Serien: 100.4 96.4 97.3  
 Zähler: 14 13 3 0 0 0 0 0 0  
 Innenzehner: 6  
 Weitester: 1953 (30.), 1802 (14.), 1795 (20.)  
 beste Teiler: 213.6 (24.), 314.9 (8.), 419.0 (1.)  
 Trefferlage: 0.38 mm links, 0.90 mm tief  
 Streuwert: 7.34, horizontal: 6.06, vertikal: 8.43

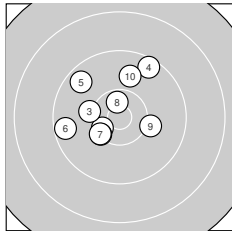
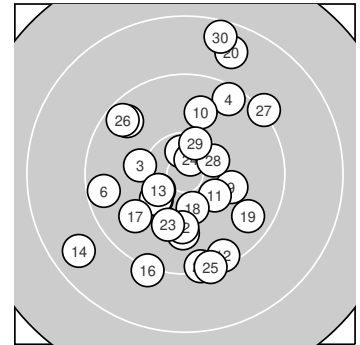

### Serie 1:

10.4 *	10.3 ↙	10.2 ←	9.5 ↗	9.6 ↘
9.5 ←	10.3 ↘	10.6 *	10.1 →	9.9 ↑

beste Teiler: 314.9 (8.), 419.0 (1.), 524.6 (2.)  
 Trefferlage: 2.27 mm links, 1.71 mm hoch  
 Streuwert: 5.54, horizontal: 5.78, vertikal: 5.28

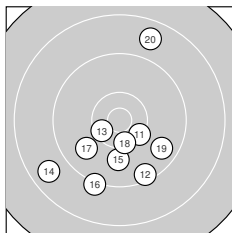

### Serie 2:

10.3 ↘	9.4 ↘	10.4 *	8.7 ↙	9.9 ↓
9.2 ↓	9.8 ↙	10.4 ↓	9.6 ↘	8.7 ↑

beste Teiler: 426.3 (13.), 476.7 (18.), 505.3 (11.)  
 Trefferlage: 0.50 mm links, 4.76 mm tief  
 Streuwert: 7.80, horizontal: 7.15, vertikal: 8.40

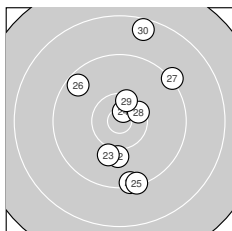

### Serie 3:

9.3 ↓	10.0 ↓	10.0 ↓	10.7 *	9.3 ↓
9.5 ↘	9.2 ↗	10.4 *	10.4 *	8.5 ↑

beste Teiler: 213.6 (24.), 430.7 (28.), 446.1 (29.)  
 Trefferlage: 1.62 mm rechts, 0.35 mm hoch  
 Streuwert: 8.07, horizontal: 5.05, vertikal: 10.23



Ergebnis: **262.7** (249)  
 Serien: 83.1 87.5 92.1  
 Zähler: 5 10 7 6 1 1 0 0 0 0  
 Innenzehner: 3  
 Weitest: 4612 (7.), 3964 (2.), 3019 (13.)  
 beste Teiler: 344.2 (18.), 393.7 (8.), 416.3 (25.)  
 Trefferlage: 5.91 mm links, 5.58 mm tief  
 Streuwert: 13.51, horizontal: 12.74, vertikal: 14.24

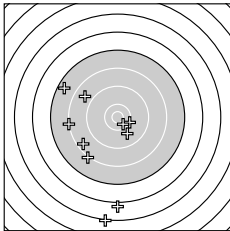
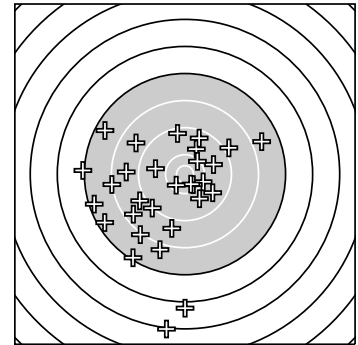

**Serie 1:**

7.6 ↖	6.0 ↓	10.2 ↘	9.9 ↘	8.2 ←
8.2 ↙	5.2 ↓	10.5 *	8.8 ↖	8.5 ↙

beste Teiler: 393.7 (8.), 584.7 (3.), 844.6 (4.)  
 Trefferlage: 8.15 mm links, 10.87 mm tief  
 Streuwert: 15.52, horizontal: 10.86, vertikal: 19.08

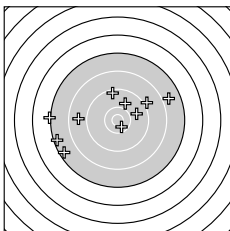

**Serie 2:**

9.4 ↑	7.9 →	7.2 ←	9.1 →	9.9 ↗
7.4 ←	7.5 ↙	10.5 *	8.8 ←	9.8 →

beste Teiler: 344.2 (18.), 812.2 (15.), 891.1 (20.)  
 Trefferlage: 5.10 mm links, 1.51 mm hoch  
 Streuwert: 14.22, horizontal: 18.28, vertikal: 8.37

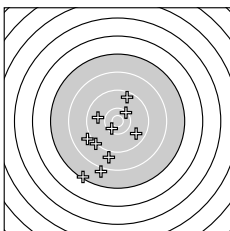

**Serie 3:**

8.9 ↓	8.0 ↓	9.7 ↘	9.8 ←	10.4 *
9.2 ↙	7.3 ↙	9.0 ↙	9.5 ↗	10.3 ↗

beste Teiler: 416.3 (25.), 528.2 (30.), 885.7 (24.)  
 Trefferlage: 4.48 mm links, 7.38 mm tief  
 Streuwert: 9.76, horizontal: 7.87, vertikal: 11.34



**Ergebnis: 276.0 (264)**  
**Serien: 93.2 90.3 92.5**  
**Zähler: 8 13 7 0 1 1 0 0 0 0**  
**Innenzehner: 6**  
**Weiteste: 4187 (15.), 3619 (5.), 2350 (26.)**  
**beste Teiler: 168.0 (13.), 223.1 (22.), 224.9 (6.)**  
**Trefferlage: 0.07 mm rechts, 0.30 mm hoch**  
**Streuwert: 12.06, horizontal: 13.75, vertikal: 10.11**

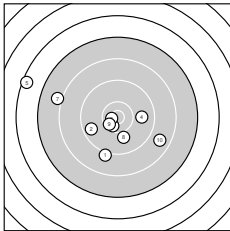
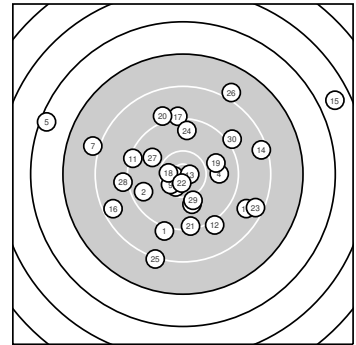

**Serie 1:**

9.1 ↓	9.6 ←	10.5 *	9.8 →	6.4 ←
10.7 *	8.0 ←	10.0 ↓	10.4 *	8.7 ↘

**beste Teiler: 224.9 (6.), 365.3 (3.), 401.1 (9.)**  
**Trefferlage: 5.06 mm links, 2.06 mm tief**  
**Streuwert: 11.52, horizontal: 14.34, vertikal: 7.72**

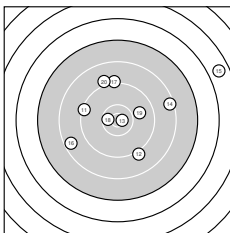

**Serie 2:**

9.3 ←	9.1 ↓	10.7 *	8.4 →	5.7 →
8.5 ←	9.2 ↑	10.5 *	9.9 →	9.0 ↑

**beste Teiler: 168.0 (13.), 361.3 (18.), 862.3 (19.)**  
**Trefferlage: 3.51 mm rechts, 3.88 mm hoch**  
**Streuwert: 13.31, horizontal: 15.98, vertikal: 9.94**

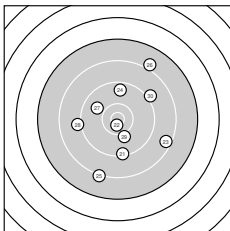

**Serie 3:**

9.3 ↓	10.7 *	8.5 ↘	9.6 ↑	8.2 ↓
8.0 ↗	9.9 ←	9.1 ←	10.1 ↓	9.1 ↗

**beste Teiler: 223.1 (22.), 694.5 (29.), 864.5 (27.)**  
**Trefferlage: 1.78 mm rechts, 0.90 mm tief**  
**Streuwert: 11.20, horizontal: 10.11, vertikal: 12.19**



Ergebnis: **287.4** (277)  
 Serien: 95.8 93.4 98.2  
 Zähler: 13 12 4 1 0 0 0 0 0 0  
 Innenzehner: 5  
 Weitestе: 2480 (20.), 2259 (16.), 2125 (10.)  
 beste Teiler: 249.6 (12.), 269.5 (13.), 280.4 (7.)  
 Trefferlage: 0.72 mm rechts, 1.12 mm hoch  
 Streuwert: 8.98, horizontal: 6.57, vertikal: 10.87

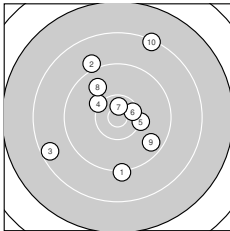
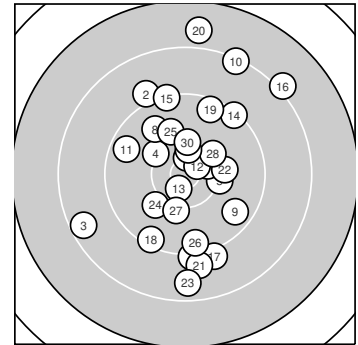

**Serie 1:**

9.2 ↓	9.0 ↖	8.5 ↙	10.2 ↖	10.2 →
10.4 *	10.6 *	9.8 ↖	9.6 ↘	8.3 ↗

beste Teiler: 280.4 (7.), 414.1 (6.), 606.8 (5.)  
 Trefferlage: 0.56 mm links, 1.81 mm hoch  
 Streuwert: 9.23, horizontal: 8.15, vertikal: 10.20

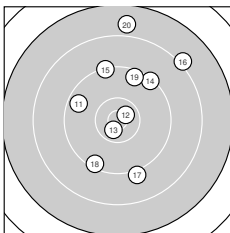

**Serie 2:**

9.6 ↖	10.6 *	10.6 *	9.3 ↗	9.3 ↑
8.1 ↗	9.1 ↓	9.4 ↙	9.5 ↗	7.9 ↑

beste Teiler: 249.6 (12.), 269.5 (13.), 1091.2 (11.)  
 Trefferlage: 1.89 mm rechts, 5.20 mm hoch  
 Streuwert: 10.09, horizontal: 7.58, vertikal: 12.09

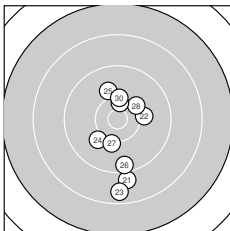

**Serie 3:**

9.0 ↓	10.1 →	8.6 ↓	10.0 ↙	10.0 ↖
9.5 ↓	10.1 ↓	10.2 ↗	10.4 *	10.3 ↑

beste Teiler: 421.1 (29.), 551.6 (30.), 594.4 (28.)  
 Trefferlage: 0.83 mm rechts, 3.63 mm tief  
 Streuwert: 7.02, horizontal: 3.44, vertikal: 9.31



Ergebnis: **297.9** (284)  
 Serien: 101.0 100.0 96.9  
 Zähler: 17 10 3 0 0 0 0 0 0  
 Innenzehner: 10  
 Weitester: 2069 (24.), 1803 (28.), 1745 (25.)  
 beste Teiler: 118.0 (22.), 177.7 (20.), 211.4 (8.)  
 Trefferlage: 0.18 mm rechts, 1.20 mm tief  
 Streuwert: 6.85, horizontal: 4.14, vertikal: 8.75

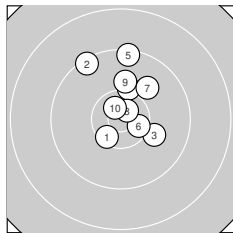
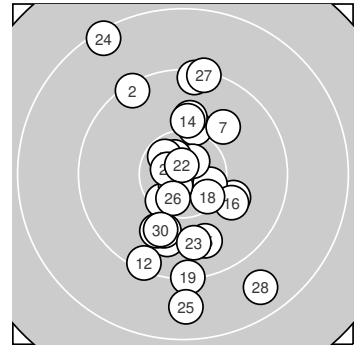

**Serie 1:**  
 10.4 \*                      9.3 ↘                      10.0 ↘                      10.2 ↑                      9.4 ↑  
 10.5 \*                      9.9 ↗                      10.7 \*                      10.0 ↑                      10.6 \*  
 beste Teiler: 211.4 (8.), 252.2 (10.), 379.6 (6.)  
 Trefferlage: 1.03 mm rechts, 3.94 mm hoch  
 Streuwert: 4.84, horizontal: 3.86, vertikal: 5.66

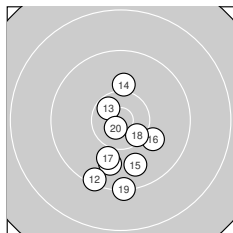

**Serie 2:**  
 9.8 ↓                      9.4 ↓                      10.5 \*                      10.1 ↑                      9.8 ↓  
 10.0 ↘                      10.0 ↓                      10.4 \*                      9.3 ↓                      10.7 \*  
 beste Teiler: 177.7 (20.), 334.4 (13.), 437.4 (18.)  
 Trefferlage: 0.07 mm rechts, 4.89 mm tief  
 Streuwert: 5.12, horizontal: 3.40, vertikal: 6.39

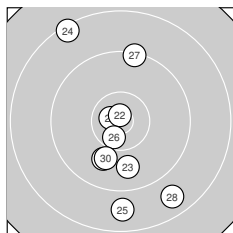

**Serie 3:**  
 10.7 \*                      10.8 \*                      9.8 ↓                      8.4 ↘                      8.8 ↓  
 10.5 \*                      9.3 ↑                      8.7 ↘                      9.9 ↓                      10.0 ↓  
 beste Teiler: 118.0 (22.), 212.5 (21.), 343.9 (26.)  
 Trefferlage: 0.55 mm links, 2.65 mm tief  
 Streuwert: 8.79, horizontal: 5.23, vertikal: 11.28



Ergebnis: **286.6** (278)  
 Serien: 95.6 97.1 93.9  
 Zähler: 12 15 2 1 0 0 0 0 0 0  
 Innenzehner: 3  
 Weitester: 2825 (29.), 2143 (5.), 2117 (7.)  
 beste Teiler: 316.5 (15.), 450.0 (9.), 472.9 (8.)  
 Trefferlage: 2.03 mm links, 0.53 mm tief  
 Streuwert: 8.79, horizontal: 5.53, vertikal: 11.13

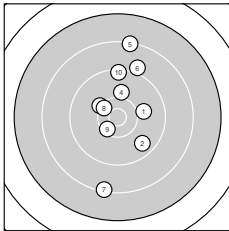
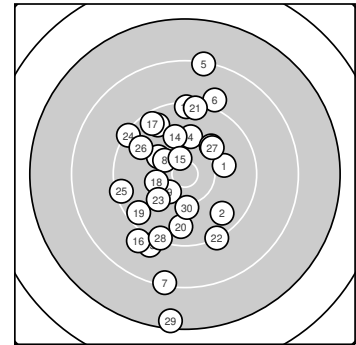

**Serie 1:**

10.0 →	9.7 ↘	10.2 ↘	10.0 ↑	8.3 ↑
9.0 ↑	8.3 ↓	10.4 *	10.4 *	9.3 ↑

beste Teiler: 450.0 (9.), 472.9 (8.), 611.3 (3.)  
 Trefferlage: 0.93 mm rechts, 3.14 mm hoch  
 Streuwert: 9.13, horizontal: 4.83, vertikal: 11.97

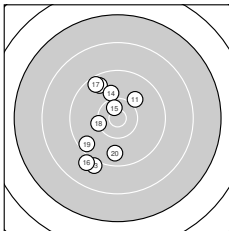

**Serie 2:**

10.0 ↗	9.6 ↘	9.0 ↓	10.0 ↑	10.6 *
9.0 ↘	9.5 ↘	10.2 ←	9.5 ↘	9.7 ↓

beste Teiler: 316.5 (15.), 566.6 (18.), 738.7 (11.)  
 Trefferlage: 4.01 mm links, 1.05 mm tief  
 Streuwert: 7.22, horizontal: 4.35, vertikal: 9.24

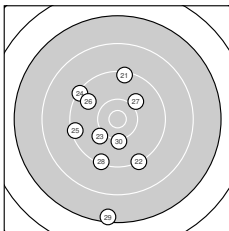

**Serie 3:**

9.3 ↑	9.2 ↓	10.1 ↙	9.3 ↘	9.4 ←
9.7 ↘	10.0 ↗	9.3 ↓	7.4 ↓	10.2 ↓

beste Teiler: 639.0 (30.), 705.9 (23.), 729.1 (27.)  
 Trefferlage: 3.04 mm links, 3.68 mm tief  
 Streuwert: 9.63, horizontal: 6.41, vertikal: 12.01



# LP Auflage 30 – Wertung –Senioren II männl.

StandNr: 92

Bohrmann, Thomas #643

StartNr: 1053

7. Mai 2022 12:00

WF Wehringhauser SGi e.V.

Ergebnis: **298.9** (286)  
 Serien: 99.9 99.2 99.8  
 Zähler: 17 12 1 0 0 0 0 0 0 0  
 Innenzehner: 6  
 Weitester: 1822 (5.), 1570 (14.), 1536 (24.)  
 beste Teiler: 242.0 (22.), 285.1 (10.), 314.6 (26.)  
 Trefferlage: 0.59 mm links, 1.72 mm tief  
 Streuwert: 6.24, horizontal: 4.93, vertikal: 7.31

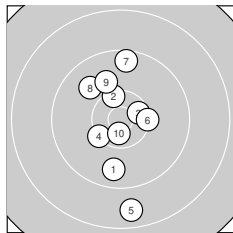
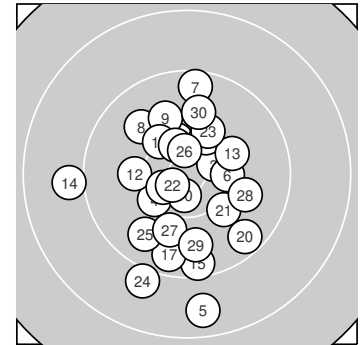

**Serie 1:**  
 9.7 ↓                      10.4 ↑                      10.5 \*                      10.3 ↙                      8.7 ↓  
 10.3 →                      9.5 ↑                      9.9 ↘                      10.0 ↑                      10.6 \*  
 beste Teiler: 285.1 (10.), 379.5 (3.), 479.2 (2.)  
 Trefferlage: 0.42 mm links, 0.31 mm tief  
 Streuwert: 6.72, horizontal: 3.55, vertikal: 8.81

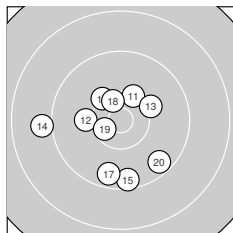

**Serie 2:**  
 10.3 ↗                      10.1 ←                      10.1 ↘                      9.0 ←                      9.5 ↓  
 10.2 ↘                      9.6 ↓                      10.4 \*                      10.5 \*                      9.5 ↘  
 beste Teiler: 362.0 (19.), 413.3 (18.), 543.9 (11.)  
 Trefferlage: 1.56 mm links, 1.79 mm tief  
 Streuwert: 6.51, horizontal: 6.70, vertikal: 6.32

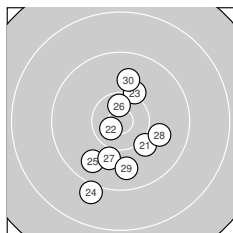

**Serie 3:**  
 10.1 ↘                      10.6 \*                      10.2 ↑                      9.0 ↓                      9.7 ↙  
 10.6 \*                      10.0 ↓                      9.9 →                      9.8 ↓                      9.9 ↑  
 beste Teiler: 242.0 (22.), 314.6 (26.), 635.0 (23.)  
 Trefferlage: 0.21 mm rechts, 3.08 mm tief  
 Streuwert: 5.89, horizontal: 4.35, vertikal: 7.11



# LP Auflage 30 – Wertung –Senioren II weibl.

StandNr: 90

**Böttcher, Heike** #622

**StartNr: 1061**

7. Mai 2022 12:06

WF SV Lennetal e.V.

**Ergebnis: 302.9** (289)  
**Serien:** 98.1 102.8 102.0  
**Zähler:** 19 11 0 0 0 0 0 0 0 0  
**Innenzehner:** 12  
**Weiteste:** 1532 (27.), 1481 (9.), 1317 (5.)  
**beste Teiler:** 218.2 (13.), 226.6 (21.), 242.7 (12.)  
**Trefferlage:** 1.07 mm rechts, 0.95 mm tief  
**Streuwert:** 5.55, horizontal: 3.77, vertikal: 6.89

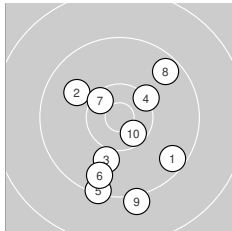
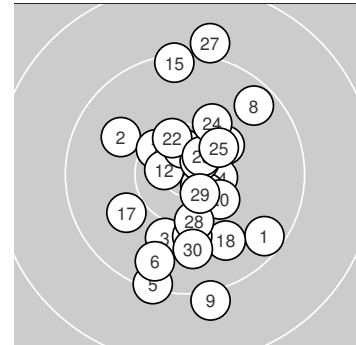

**Serie 1:**

9.5 ↘	9.9 ↘	10.0 ↓	10.2 ↗	9.3 ↓
9.6 ↓	10.4 *	9.6 ↗	9.1 ↓	10.5 *

**beste Teiler:** 363.9 (10.), 439.7 (7.), 564.8 (4.)  
**Trefferlage:** 0.67 mm rechts, 3.60 mm tief  
**Streuwert:** 6.77, horizontal: 5.51, vertikal: 7.83

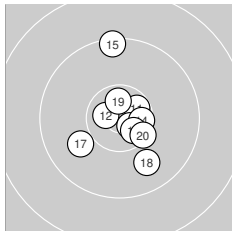

**Serie 2:**

10.5 *	10.6 *	10.7 *	10.5 *	9.3 ↑
10.6 *	9.9 ↙	9.8 ↘	10.6 *	10.3 ↘

**beste Teiler:** 218.2 (13.), 242.7 (12.), 295.9 (19.)  
**Trefferlage:** 0.90 mm rechts, 0.08 mm tief  
**Streuwert:** 4.61, horizontal: 3.57, vertikal: 5.46

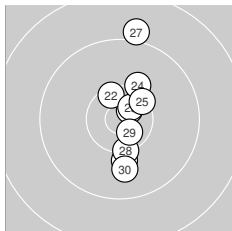

**Serie 3:**

10.7 *	10.4 *	10.6 *	10.1 ↗	10.3 ↗
10.1 ↓	9.0 ↑	10.3 ↓	10.6 *	9.9 ↓

**beste Teiler:** 226.6 (21.), 281.6 (29.), 282.9 (23.)  
**Trefferlage:** 1.65 mm rechts, 0.82 mm hoch  
**Streuwert:** 5.09, horizontal: 1.50, vertikal: 7.04





Ergebnis: **298.0** (282)  
 Serien: 99.9 101.4 96.7  
 Zähler: 15 12 3 0 0 0 0 0 0 0  
 Innenzehner: 9  
 Weitester: 1883 (27.), 1749 (28.), 1603 (23.)  
 beste Teiler: 71.5 (25.), 234.0 (8.), 284.4 (15.)  
 Trefferlage: 1.27 mm rechts, 1.06 mm tief  
 Streuwert: 6.58, horizontal: 4.30, vertikal: 8.25

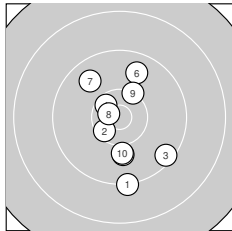
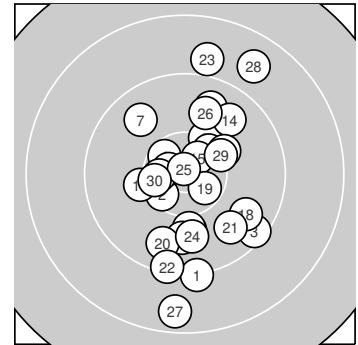

**Serie 1:**  
 9.2 ↓                      10.4 \*                      9.4 ↘                      10.5 \*                      10.0 ↓  
 9.7 ↗                      9.8 ↖                      10.7 \*                      10.2 ↗                      10.0 ↓  
 beste Teiler: 234.0 (8.), 374.0 (4.), 417.2 (2.)  
 Trefferlage: 0.44 mm rechts, 1.47 mm tief  
 Streuwert: 6.20, horizontal: 4.36, vertikal: 7.61

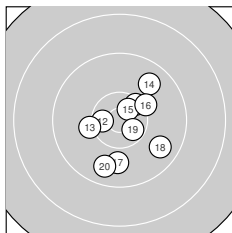

**Serie 2:**  
 10.4 \*                      10.5 \*                      10.2 ←                      9.7 ↗                      10.6 \*  
 10.2 ↗                      9.9 ↓                      9.7 ↘                      10.5 \*                      9.7 ↓  
 beste Teiler: 284.4 (15.), 332.9 (19.), 352.4 (12.)  
 Trefferlage: 1.44 mm rechts, 1.11 mm tief  
 Streuwert: 5.08, horizontal: 4.66, vertikal: 5.48

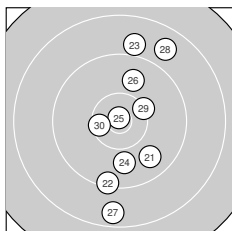

**Serie 3:**  
 9.8 ↘                      9.3 ↓                      8.9 ↑                      9.9 ↓                      10.9 \*  
 9.8 ↗                      8.6 ↓                      8.8 ↗                      10.3 ↗                      10.4 \*  
 beste Teiler: 71.5 (25.), 424.0 (30.), 556.0 (29.)  
 Trefferlage: 1.93 mm rechts, 0.59 mm tief  
 Streuwert: 8.62, horizontal: 4.19, vertikal: 11.45



**Ergebnis: 279.7 (267)**  
**Serien: 89.3 90.9 99.5**  
**Zähler: 10 12 5 2 0 1 0 0 0 0**  
**Innenzehner: 3**  
**Weiteste: 4122 (4.), 3071 (17.), 2850 (10.)**  
**beste Teiler: 128.3 (25.), 298.0 (22.), 355.2 (29.)**  
**Trefferlage: 0.26 mm links, 5.08 mm hoch**  
**Streuwert: 10.57, horizontal: 10.53, vertikal: 10.62**

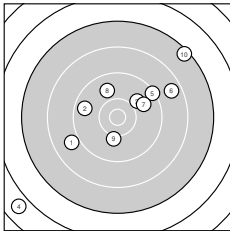
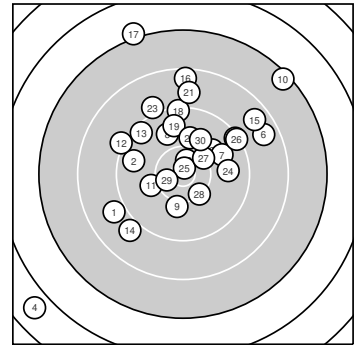

**Serie 1:**  
 8.9 ↙                      9.6 ↖                      10.0 ↗                      5.8 ↘                      9.3 ↗  
 8.6 ↗                      9.8 ↗                      9.8 ↘                      10.1 ↓                      7.4 ↗  
**beste Teiler: 680.2 (9.), 784.7 (3.), 886.5 (8.)**  
**Trefferlage: 0.27 mm rechts, 1.32 mm hoch**  
**Streuwert: 14.25, horizontal: 15.56, vertikal: 12.80**

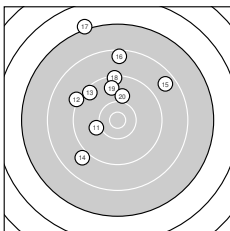

**Serie 2:**  
 10.1 ↙                      9.2 ↖                      9.4 ↖                      9.0 ↘                      8.6 ↗  
 8.5 ↑                      7.1 ↘                      9.3 ↑                      9.7 ↑                      10.0 ↑  
**beste Teiler: 698.9 (11.), 764.0 (20.), 1016.9 (19.)**  
**Trefferlage: 3.51 mm links, 9.17 mm hoch**  
**Streuwert: 9.74, horizontal: 8.21, vertikal: 11.06**

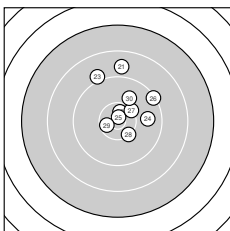

**Serie 3:**  
 8.8 ↑                      10.6 \*                      9.1 ↘                      9.8 →                      10.8 \*  
 9.3 ↗                      10.3 ↗                      10.3 ↘                      10.5 \*                      10.0 ↗  
**beste Teiler: 128.3 (25.), 298.0 (22.), 355.2 (29.)**  
**Trefferlage: 2.43 mm rechts, 4.77 mm hoch**  
**Streuwert: 5.93, horizontal: 5.23, vertikal: 6.56**



**Ergebnis: 300.5 (288)**  
**Serien: 100.6 100.2 99.7**  
**Zähler: 19 10 1 0 0 0 0 0 0 0**  
**Innenzehner: 10**  
**Weiteste: 1863 (22.), 1356 (15.), 1247 (19.)**  
**beste Teiler: 111.7 (11.), 242.1 (4.), 283.2 (8.)**  
**Trefferlage: 3.06 mm links, 1.68 mm tief**  
**Streuwert: 5.61, horizontal: 5.36, vertikal: 5.85**

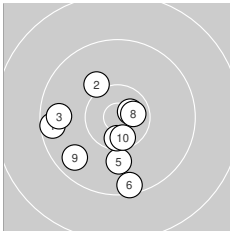
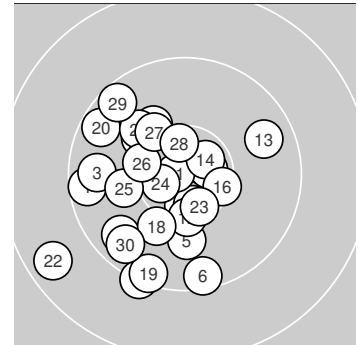

**Serie 1:**

9.5 ←	10.1 ↘	9.7 ←	10.6 *	10.0 ↓
9.4 ↓	10.5 *	10.6 *	9.7 ↙	10.5 *

**beste Teiler: 242.1 (4.), 283.2 (8.), 371.2 (7.)**  
**Trefferlage: 2.51 mm links, 2.81 mm tief**  
**Streuwert: 5.31, horizontal: 5.44, vertikal: 5.17**

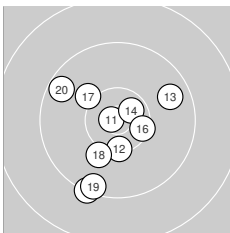

**Serie 2:**

10.8 *	10.3 ↓	9.7 →	10.6 *	9.3 ↓
10.4 *	10.1 ↘	10.1 ↙	9.4 ↓	9.5 ↘

**beste Teiler: 111.7 (11.), 296.8 (14.), 463.9 (16.)**  
**Trefferlage: 1.29 mm links, 2.10 mm tief**  
**Streuwert: 6.07, horizontal: 5.59, vertikal: 6.51**

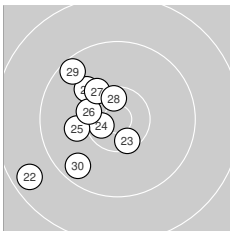

**Serie 3:**

10.0 ↘	8.6 ↙	10.4 *	10.6 *	10.0 ←
10.3 ↖	10.2 ↘	10.5 *	9.5 ↘	9.6 ↙

**beste Teiler: 307.7 (24.), 375.0 (28.), 420.3 (23.)**  
**Trefferlage: 5.37 mm links, 0.13 mm tief**  
**Streuwert: 5.42, horizontal: 4.70, vertikal: 6.06**



**Ergebnis:** **263.3** (249)  
**Serien:** 83.1 87.7 92.5  
**Zähler:** 6 6 13 3 1 0 1 0 0 0  
**Innenzehner:** 4  
**Weiteste:** 5503 (2.), 3527 (8.), 3166 (16.)  
**beste Teiler:** 182.0 (15.), 224.5 (3.), 251.6 (21.)  
**Trefferlage:** 1.88 mm rechts, 8.71 mm hoch  
**Streuwert:** 13.33, horizontal: 7.93, vertikal: 17.09

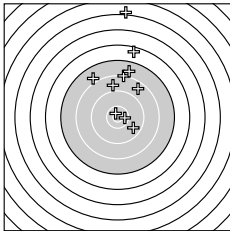
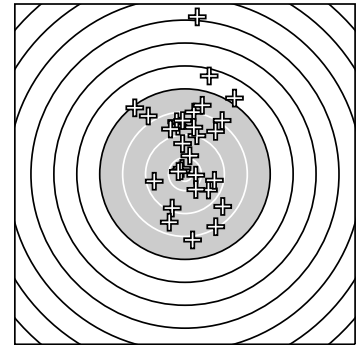

**Serie 1:**

8.7 ↗	4.1 ↑	10.7 *	10.5 *	8.2 ↑
8.8 ↑	7.9 ↑	6.5 ↑	9.7 ↘	8.0 ↘

**beste Teiler:** 224.5 (3.), 377.7 (4.), 990.1 (9.)  
**Trefferlage:** 2.82 mm rechts, 18.27 mm hoch  
**Streuwert:** 13.46, horizontal: 6.85, vertikal: 17.75

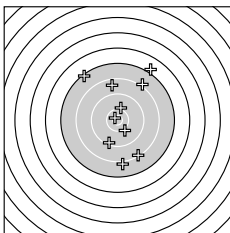

**Serie 2:**

7.3 ↘	8.1 ↗	10.1 ↑	10.1 ↘	10.7 *
7.0 ↗	8.3 ↘	8.6 ↑	8.1 ↓	9.4 ↙

**beste Teiler:** 182.0 (15.), 658.0 (14.), 662.9 (13.)  
**Trefferlage:** 2.28 mm rechts, 3.56 mm hoch  
**Streuwert:** 14.46, horizontal: 9.95, vertikal: 17.86

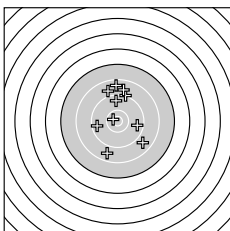

**Serie 3:**

10.6 *	8.9 ↑	9.2 ↑	8.8 ↘	8.6 ↑
9.6 ←	9.6 →	9.6 ↑	8.9 ↑	8.7 ↙

**beste Teiler:** 251.6 (21.), 1050.2 (27.), 1068.3 (28.)  
**Trefferlage:** 0.54 mm rechts, 4.30 mm hoch  
**Streuwert:** 10.20, horizontal: 7.31, vertikal: 12.44



Ergebnis: **255.7** (241)  
 Serien: 79.0 89.4 87.3  
 Zähler: 5 9 8 1 4 3 0 0 0 0  
 Innenzehner: 4  
 Weitest: 4386 (25.), 4183 (6.), 4111 (28.)  
 beste Teiler: 270.4 (12.), 287.9 (1.), 360.6 (30.)  
 Trefferlage: 13.31 mm links, 1.10 mm hoch  
 Streuwert: 13.40, horizontal: 15.51, vertikal: 10.88

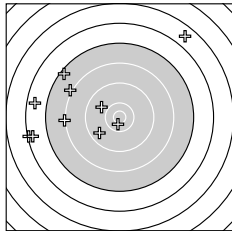
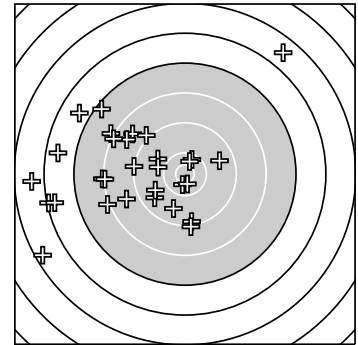

**Serie 1:**

10.6 *	9.9 ↘	7.4 ↘	8.2 ←	8.1 ↘
5.7 ↗	6.6 ←	9.7 ↗	6.3 ←	6.5 ←

beste Teiler: 287.9 (1.), 831.8 (2.), 1027.3 (8.)  
 Trefferlage: 15.95 mm links, 4.48 mm hoch  
 Streuwert: 16.42, horizontal: 19.32, vertikal: 12.89

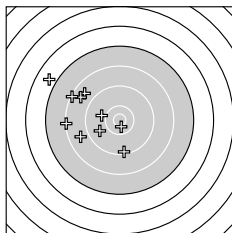

**Serie 2:**

6.9 ↘	10.6 *	9.3 ↓	8.8 ←	9.8 ←
8.7 ↘	8.7 ↘	8.3 ↘	10.0 ←	8.3 ←

beste Teiler: 270.4 (12.), 745.1 (19.), 902.8 (15.)  
 Trefferlage: 12.69 mm links, 2.01 mm hoch  
 Streuwert: 9.35, horizontal: 9.54, vertikal: 9.16

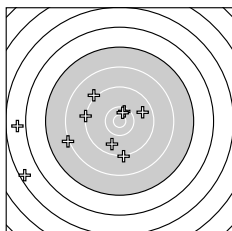

**Serie 3:**

10.4 *	8.2 ←	9.2 ←	9.7 ↓	5.5 ←
9.1 ↘	9.7 →	5.8 ←	9.2 ↓	10.5 *

beste Teiler: 360.6 (30.), 434.3 (21.), 971.1 (24.)  
 Trefferlage: 11.31 mm links, 3.16 mm tief  
 Streuwert: 14.07, horizontal: 17.28, vertikal: 9.86



**Ergebnis: 278.6 (264)**  
**Serien: 83.7 96.8 98.1**  
**Zähler: 11 9 6 1 3 0 0 0 0 0**  
**Innenzehner: 3**  
**Weiteste: 3821 (5.), 3354 (4.), 3240 (1.)**  
**beste Teiler: 226.8 (19.), 362.4 (30.), 372.3 (29.)**  
**Trefferlage: 0.85 mm rechts, 1.20 mm hoch**  
**Streuwert: 11.70, horizontal: 8.48, vertikal: 14.21**

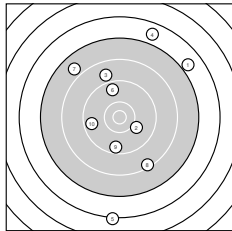
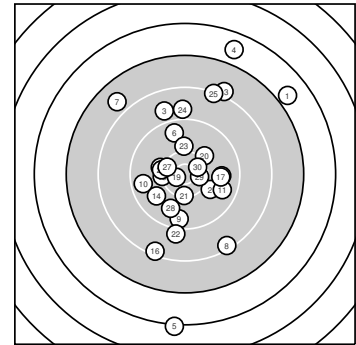

**Serie 1:**

6.9 ↗	10.0 ↘	8.9 ↑	6.8 ↗	6.2 ↓
9.6 ↑	7.8 ↘	8.4 ↘	9.5 ↓	9.6 ←

**beste Teiler: 739.8 (2.), 1066.9 (6.), 1072.9 (10.)**  
**Trefferlage: 1.54 mm rechts, 2.17 mm hoch**  
**Streuwert: 17.16, horizontal: 12.39, vertikal: 20.87**

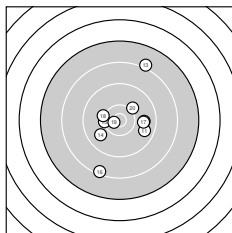

**Serie 2:**

9.7 ↘	9.8 →	8.1 ↗	9.8 ↖	10.2 ←
8.4 ↓	9.8 →	10.2 ←	10.7 *	10.1 ↗

**beste Teiler: 226.8 (19.), 572.9 (15.), 640.9 (18.)**  
**Trefferlage: 1.36 mm rechts, 0.41 mm tief**  
**Streuwert: 8.84, horizontal: 7.72, vertikal: 9.83**

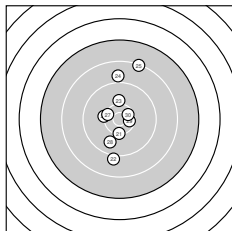

**Serie 3:**

10.3 ↓	9.1 ↓	10.1 ↑	8.9 ↑	8.3 ↗
10.2 ←	10.4 ←	9.8 ↓	10.5 *	10.5 *

**beste Teiler: 362.4 (30.), 372.3 (29.), 480.7 (27.)**  
**Trefferlage: 0.32 mm links, 1.85 mm hoch**  
**Streuwert: 8.06, horizontal: 4.05, vertikal: 10.66**



Ergebnis: **282.5** (270)  
 Serien: 95.9 90.2 96.4  
 Zähler: 8 16 4 2 0 0 0 0 0 0  
 Innenzehner: 1  
 Weitesten: 3017 (12.), 2843 (20.), 1711 (3.)  
 beste Teiler: 359.4 (29.), 510.1 (27.), 589.1 (16.)  
 Trefferlage: 3.05 mm rechts, 1.86 mm tief  
 Streuwert: 9.44, horizontal: 8.20, vertikal: 10.54

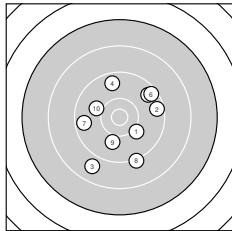
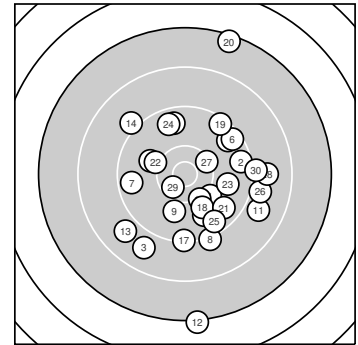

**Serie 1:**

10.1 ↘	9.5 →	8.8 ↙	9.6 ↑	9.6 ↗
9.5 ↗	9.6 ←	9.2 ↘	10.0 ↓	10.0 ↖

beste Teiler: 674.6 (1.), 756.2 (10.), 785.2 (9.)  
 Trefferlage: 0.93 mm rechts, 1.22 mm tief  
 Streuwert: 8.40, horizontal: 8.09, vertikal: 8.70

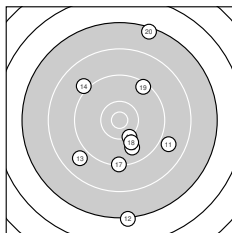

**Serie 2:**

8.9 ↘	7.2 ↓	8.9 ↙	9.1 ↖	9.8 ↘
10.2 ↘	9.3 ↓	10.0 ↘	9.4 ↗	7.4 ↑

beste Teiler: 589.1 (16.), 761.2 (18.), 916.4 (15.)  
 Trefferlage: 2.06 mm rechts, 3.50 mm tief  
 Streuwert: 12.59, horizontal: 8.30, vertikal: 15.75

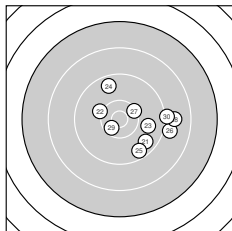

**Serie 3:**

9.6 ↘	10.1 ↖	9.8 →	9.6 ↑	9.5 ↘
9.0 →	10.3 ↗	8.9 →	10.5 *	9.1 →

beste Teiler: 359.4 (29.), 510.1 (27.), 646.2 (22.)  
 Trefferlage: 6.17 mm rechts, 0.87 mm tief  
 Streuwert: 6.91, horizontal: 8.08, vertikal: 5.48







Ergebnis: **289.5** (277)  
 Serien: 98.0 95.6 95.9  
 Zähler: 12 14 3 1 0 0 0 0 0 0  
 Innenzehner: 3  
 Weitester: 2541 (16.), 2028 (3.), 1901 (28.)  
 beste Teiler: 102.8 (22.), 218.9 (18.), 456.5 (10.)  
 Trefferlage: 0.38 mm links, 3.31 mm tief  
 Streuwert: 8.04, horizontal: 7.74, vertikal: 8.33

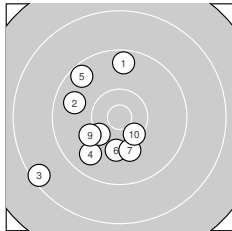
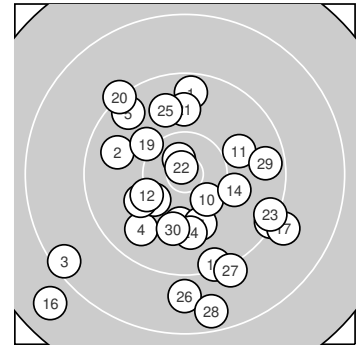

**Serie 1:**

9.6 ↑	9.7 ↖	8.4 ↙	9.8 ↙	9.5 ↖
10.1 ↓	10.1 ↓	10.3 ↙	10.1 ↙	10.4 *

beste Teiler: 456.5 (10.), 543.9 (8.), 676.6 (6.)  
 Trefferlage: 4.43 mm links, 2.09 mm tief  
 Streuwert: 6.69, horizontal: 5.98, vertikal: 7.33

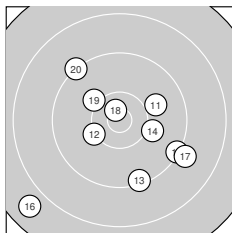

**Serie 2:**

9.9 →	10.2 ↖	9.3 ↓	10.1 →	9.3 →
7.8 ↙	9.0 →	10.7 *	10.1 ↖	9.2 ↖

beste Teiler: 218.9 (18.), 593.8 (12.), 663.7 (19.)  
 Trefferlage: 0.47 mm rechts, 2.89 mm tief  
 Streuwert: 9.22, horizontal: 10.01, vertikal: 8.34

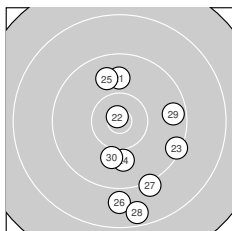

**Serie 3:**

9.8 ↑	10.8 *	9.3 →	10.0 ↓	9.8 ↑
8.9 ↓	9.1 ↓	8.6 ↓	9.6 →	10.0 ↓

beste Teiler: 102.8 (22.), 760.6 (30.), 800.5 (24.)  
 Trefferlage: 2.82 mm rechts, 4.93 mm tief  
 Streuwert: 7.80, horizontal: 5.14, vertikal: 9.76



Ergebnis: **277.3** (264)  
 Serien: 93.0 94.7 89.6  
 Zähler: 8 12 7 2 1 0 0 0 0 0  
 Innenzehner: 6  
 Weitester: 3516 (10.), 3012 (22.), 2572 (18.)  
 beste Teiler: 204.2 (19.), 250.4 (11.), 281.4 (16.)  
 Trefferlage: 1.37 mm rechts, 4.20 mm tief  
 Streuwert: 11.13, horizontal: 6.37, vertikal: 14.39

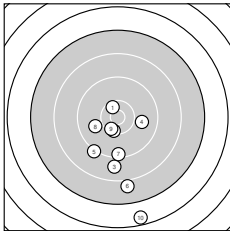
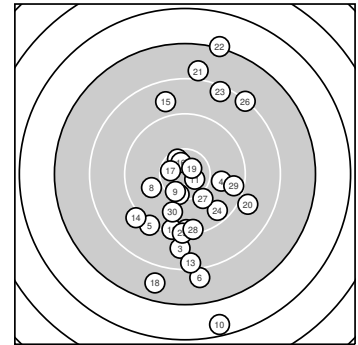

**Serie 1:**

10.5 *	10.3 ↓	8.8 ↓	9.9 →	9.2 ↙
8.0 ↓	9.4 ↓	9.9 ↖	10.4 *	6.6 ↓

beste Teiler: 382.8 (1.), 451.1 (9.), 481.7 (2.)  
 Trefferlage: 0.21 mm links, 10.88 mm tief  
 Streuwert: 9.02, horizontal: 5.54, vertikal: 11.49

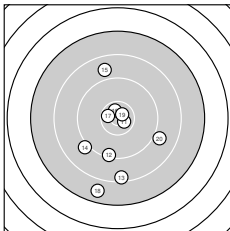

**Serie 2:**

10.6 *	9.3 ↓	8.4 ↓	9.1 ↙	8.8 ↑
10.6 *	10.5 *	7.7 ↓	10.7 *	9.0 →

beste Teiler: 204.2 (19.), 250.4 (11.), 281.4 (16.)  
 Trefferlage: 1.02 mm links, 5.43 mm tief  
 Streuwert: 9.81, horizontal: 6.80, vertikal: 12.10

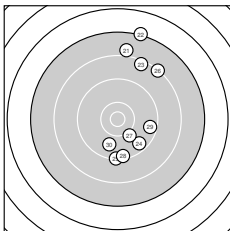

**Serie 3:**

8.0 ↑	7.2 ↑	8.4 ↑	9.6 ↘	9.3 ↓
8.3 ↗	10.1 ↘	9.4 ↓	9.5 →	9.8 ↓

beste Teiler: 689.4 (27.), 906.6 (30.), 1108.3 (24.)  
 Trefferlage: 5.36 mm rechts, 3.69 mm hoch  
 Streuwert: 12.15, horizontal: 5.20, vertikal: 16.37



Ergebnis: **292.0** (280)  
 Serien: 100.3 94.0 97.7  
 Zähler: 16 11 2 0 0 1 0 0 0 0  
 Innenzehner: 8  
 Weitesten: 4777 (18.), 2347 (19.), 2088 (24.)  
 beste Teiler: 187.1 (22.), 203.0 (10.), 269.2 (23.)  
 Trefferlage: 0.69 mm rechts, 0.80 mm hoch  
 Streuwert: 9.35, horizontal: 5.86, vertikal: 11.86

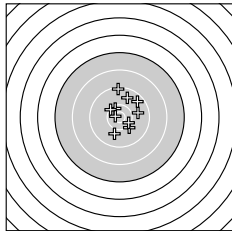
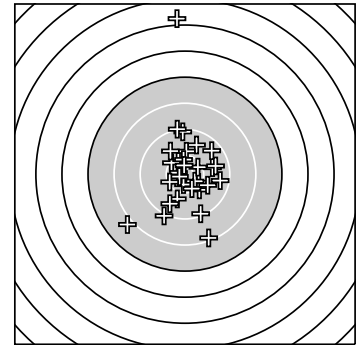

**Serie 1:**  
 10.1 ↘                      9.9 →                      10.4 \*                      9.3 ↑                      9.7 ↑  
 10.3 ↙                      9.6 ↗                      10.0 ↓                      10.3 ↘                      10.7 \*  
 beste Teiler: 203.0 (10.), 450.7 (3.), 488.2 (9.)  
 Trefferlage: 1.75 mm rechts, 2.40 mm hoch  
 Streuwert: 5.53, horizontal: 4.58, vertikal: 6.34

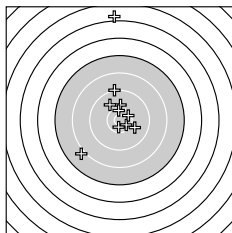

**Serie 2:**  
 10.0 ↘                      10.5 \*                      9.2 ↑                      10.4 \*                      10.1 ↑  
 10.5 \*                      9.9 ↙                      5.0 ↑                      8.0 ↙                      10.4 \*  
 beste Teiler: 322.0 (16.), 374.8 (12.), 448.0 (20.)  
 Trefferlage: 1.33 mm links, 5.79 mm hoch  
 Streuwert: 12.74, horizontal: 6.66, vertikal: 16.73

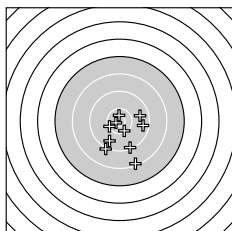

**Serie 3:**  
 9.3 ↓                      10.7 \*                      10.6 \*                      8.3 ↓                      9.7 ↓  
 10.3 ↙                      10.3 ↓                      9.7 →                      9.6 →                      9.2 ↓  
 beste Teiler: 187.1 (22.), 269.2 (23.), 493.3 (27.)  
 Trefferlage: 1.67 mm rechts, 5.80 mm tief  
 Streuwert: 6.79, horizontal: 6.19, vertikal: 7.34



Ergebnis: **281.1** (271)  
 Serien: 89.7 95.7 95.7  
 Zähler: 9 15 4 2 0 0 0 0 0 0  
 Innenzehner: 2  
 Weitesten: 2935 (6.), 2487 (3.), 2209 (28.)  
 beste Teiler: 366.1 (20.), 390.3 (16.), 621.3 (30.)  
 Trefferlage: 1.48 mm rechts, 1.16 mm tief  
 Streuwert: 10.06, horizontal: 10.79, vertikal: 9.27

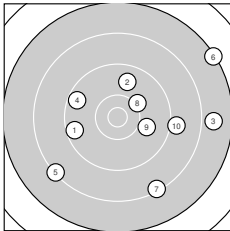
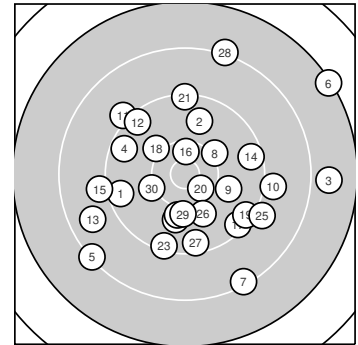

**Serie 1:**  
 9.5 ←                      9.8 ↑                      7.8 →                      9.5 ↖                      8.3 ↙  
 7.3 ↗                      8.3 ↘                      10.2 ↘                      10.0 →                      9.0 →  
 beste Teiler: 629.0 (8.), 794.6 (9.), 948.8 (2.)  
 Trefferlage: 5.25 mm rechts, 0.89 mm tief  
 Streuwert: 12.47, horizontal: 14.41, vertikal: 10.15

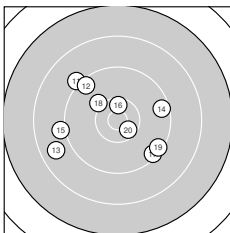

**Serie 2:**  
 9.1 ↘                      9.4 ↘                      8.7 ←                      9.5 →                      9.1 ←  
 10.5 \*                      9.4 ↘                      10.1 ↘                      9.4 ↘                      10.5 \*  
 beste Teiler: 366.1 (20.), 390.3 (16.), 666.5 (18.)  
 Trefferlage: 2.05 mm links, 0.19 mm hoch  
 Streuwert: 8.79, horizontal: 10.36, vertikal: 6.88

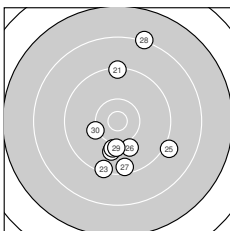

**Serie 3:**  
 9.3 ↑                      9.9 ↓                      9.3 ↓                      10.1 ↓                      9.1 ↘  
 10.0 ↓                      9.5 ↓                      8.2 ↑                      10.1 ↓                      10.2 ←  
 beste Teiler: 621.3 (30.), 686.8 (29.), 715.7 (24.)  
 Trefferlage: 1.25 mm rechts, 2.79 mm tief  
 Streuwert: 8.72, horizontal: 5.50, vertikal: 11.03



**Ergebnis: 266.4 (251)**  
**Serien: 90.5 90.7 85.2**  
**Zähler: 3 13 8 4 2 0 0 0 0 0**  
**Innenzehner: 1**  
**Weiteste: 3721 (24.), 3250 (5.), 2716 (25.)**  
**beste Teiler: 352.6 (10.), 587.6 (4.), 762.3 (9.)**  
**Trefferlage: 0.84 mm links, 5.31 mm hoch**  
**Streuwert: 12.62, horizontal: 8.18, vertikal: 15.87**

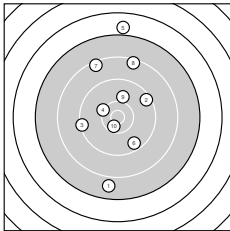
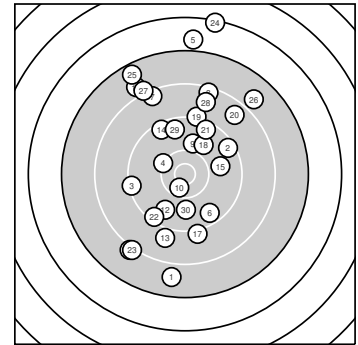

**Serie 1:**

7.8 ↓	9.4 ↗	9.3 ←	10.2 ↖	6.9 ↑
9.6 ↘	8.4 ↖	8.4 ↑	10.0 ↑	10.5 *

**beste Teiler: 352.6 (10.), 587.6 (4.), 762.3 (9.)**  
**Trefferlage: 0.46 mm links, 4.70 mm hoch**  
**Streuwert: 12.56, horizontal: 7.05, vertikal: 16.30**

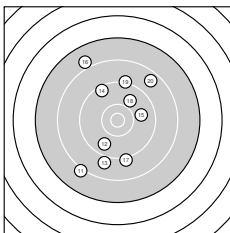

**Serie 2:**

8.1 ↖	9.7 ↙	8.9 ↓	9.4 ↘	9.9 →
7.9 ↗	9.1 ↓	9.9 ↗	9.2 ↑	8.6 ↗

**beste Teiler: 834.6 (18.), 874.8 (15.), 981.6 (12.)**  
**Trefferlage: 0.94 mm links, 1.21 mm hoch**  
**Streuwert: 11.73, horizontal: 8.43, vertikal: 14.29**

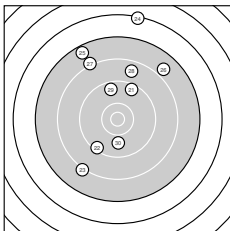

**Serie 3:**

9.5 ↗	9.4 ↙	8.2 ↙	6.3 ↑	7.6 ↘
7.9 ↗	8.1 ↘	8.7 ↑	9.6 ↑	9.9 ↓

**beste Teiler: 858.3 (30.), 1104.0 (29.), 1184.9 (21.)**  
**Trefferlage: 1.11 mm links, 10.02 mm hoch**  
**Streuwert: 14.00, horizontal: 9.74, vertikal: 17.25**



**Ergebnis:** **303.6** (291)  
**Serien:** 104.6 101.8 97.2  
**Zähler:** 23 6 0 1 0 0 0 0 0  
**Innenzehner:** 17  
**Weiteste:** 941 (29.), 407 (21.), 343 (28.)  
**beste Teiler:** 57.3 (26.), 58.6 (10.), 63.0 (3.)  
**Trefferlage:** 0.37 mm links, 0.39 mm tief  
**Streuwert:** 1.87, horizontal: 1.75, vertikal: 1.98

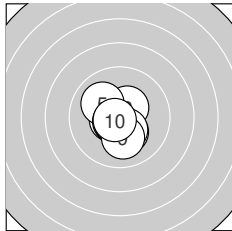
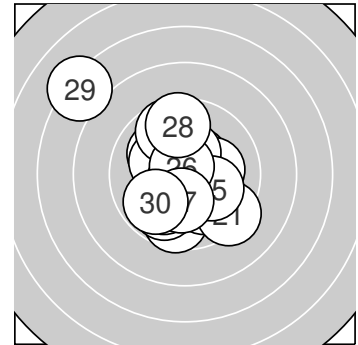

**Serie 1:**

10.3 *	10.4 *	10.7 *	10.6 *	10.0 ↘
10.7 *	10.7 *	10.4 *	10.1 ↓	10.7 *

**beste Teiler:** 58.6 (10.), 63.0 (3.), 67.3 (7.)  
**Trefferlage:** 0.19 mm links, 0.45 mm tief  
**Streuwert:** 0.96, horizontal: 0.84, vertikal: 1.07

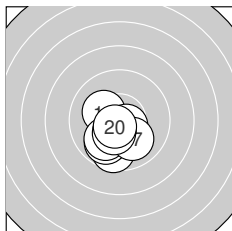

**Serie 2:**

10.2 *	10.0 ↓	9.6 ↓	10.6 *	9.9 ↙
10.0 ↗	10.0 ↘	10.5 *	10.4 *	10.6 *

**beste Teiler:** 82.2 (20.), 90.1 (14.), 110.0 (18.)  
**Trefferlage:** 0.49 mm links, 1.44 mm tief  
**Streuwert:** 1.05, horizontal: 0.94, vertikal: 1.16

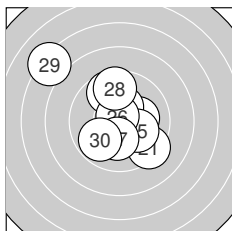

**Serie 3:**

9.3 ↘	9.7 ↗	10.2 *	10.4 *	10.1 ↘
10.7 *	10.2 *	9.6 ↑	7.2 ↘	9.8 ↙

**beste Teiler:** 57.3 (26.), 150.0 (24.), 184.6 (27.)  
**Trefferlage:** 0.44 mm links, 0.71 mm hoch  
**Streuwert:** 2.81, horizontal: 2.86, vertikal: 2.76



Ergebnis: **309.5** (295)  
 Serien: 102.7 105.1 101.7  
 Zähler: 25 5 0 0 0 0 0 0 0 0  
 Innenzehner: 21  
 Weitesten: 450 (28.), 295 (25.), 292 (21.)  
 beste Teiler: 31.6 (14.), 40.6 (24.), 49.3 (3.)  
 Trefferlage: 0.28 mm links, 0.31 mm hoch  
 Streuwert: 1.32, horizontal: 1.44, vertikal: 1.19

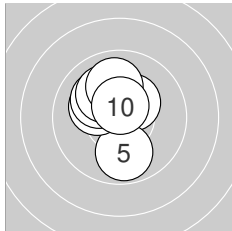
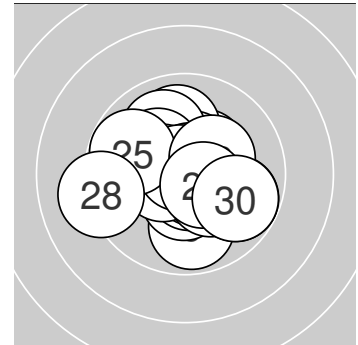

**Serie 1:**

10.4 *	10.2 *	10.8 *	10.4 *	9.9 ↓
10.2 *	10.1 ↖	10.1 ↖	10.0 ↑	10.6 *

beste Teiler: 49.3 (3.), 91.1 (10.), 142.0 (1.)  
 Trefferlage: 0.53 mm links, 0.90 mm hoch  
 Streuwert: 1.17, horizontal: 0.89, vertikal: 1.40

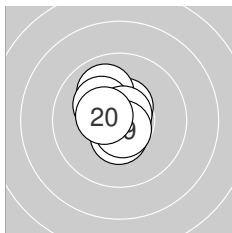

**Serie 2:**

10.5 *	10.6 *	10.0 ↖	10.8 *	10.6 *
10.2 *	10.7 *	10.5 *	10.7 *	10.5 *

beste Teiler: 31.6 (14.), 51.3 (17.), 73.0 (19.)  
 Trefferlage: 0.41 mm links, 0.40 mm hoch  
 Streuwert: 0.84, horizontal: 0.69, vertikal: 0.97

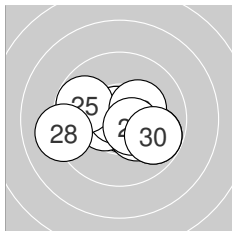

**Serie 3:**

9.8 ↘	10.7 *	10.5 *	10.8 *	9.8 ↖
10.3 *	10.3 *	9.2 ←	10.5 *	9.8 ↘

beste Teiler: 40.6 (24.), 70.0 (22.), 110.7 (29.)  
 Trefferlage: 0.09 mm rechts, 0.35 mm tief  
 Streuwert: 1.72, horizontal: 2.28, vertikal: 0.87



Ergebnis: **304.9** (291)  
 Serien: 100.3 101.4 103.2  
 Zähler: 21 9 0 0 0 0 0 0 0  
 Innenzehner: 20  
 Weitestе: 391 (14.), 385 (24.), 379 (2.)  
 beste Teiler: 57.2 (21.), 70.7 (30.), 71.1 (28.)  
 Trefferlage: 0.10 mm rechts, 0.32 mm hoch  
 Streuwert: 1.58, horizontal: 1.86, vertikal: 1.23

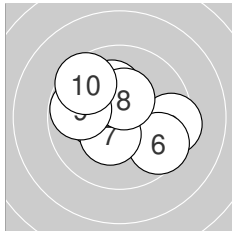
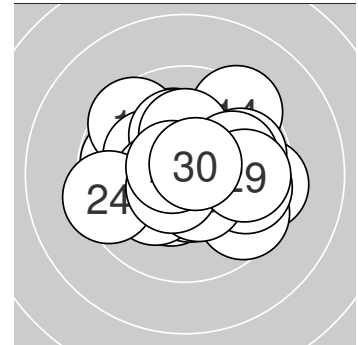

**Serie 1:**

10.3 *	9.4 →	10.2 *	10.4 *	10.2 *
9.6 ↘	10.4 *	10.4 *	9.8 ←	9.6 ↖

beste Teiler: 126.7 (4.), 136.7 (8.), 141.4 (7.)  
 Trefferlage: 0.28 mm links, 0.53 mm hoch  
 Streuwert: 1.80, horizontal: 2.11, vertikal: 1.42

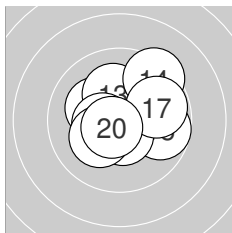

**Serie 2:**

10.4 *	10.2 *	10.2 *	9.4 ↗	9.7 →
10.5 *	9.8 →	10.4 *	10.2 *	10.6 *

beste Teiler: 77.1 (20.), 107.7 (16.), 126.6 (18.)  
 Trefferlage: 0.41 mm rechts, 0.34 mm hoch  
 Streuwert: 1.60, horizontal: 1.80, vertikal: 1.36

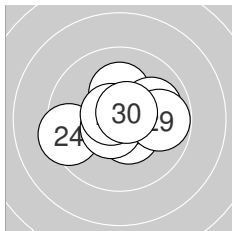

**Serie 3:**

10.7 *	10.6 *	10.5 *	9.4 ←	10.2 *
10.0 →	10.6 *	10.7 *	9.8 →	10.7 *

beste Teiler: 57.2 (21.), 70.7 (30.), 71.1 (28.)  
 Trefferlage: 0.18 mm rechts, 0.09 mm hoch  
 Streuwert: 1.43, horizontal: 1.79, vertikal: 0.95





Ergebnis: **308.3** (294)  
 Serien: 103.7 100.8 103.8  
 Zähler: 24 6 0 0 0 0 0 0 0 0  
 Innenzehner: 20  
 Weitestе: 358 (6.), 336 (16.), 296 (29.)  
 beste Teiler: 38.0 (4.), 79.2 (19.), 83.2 (28.)  
 Trefferlage: 0.60 mm rechts, 0.22 mm hoch  
 Streuwert: 1.28, horizontal: 1.37, vertikal: 1.18

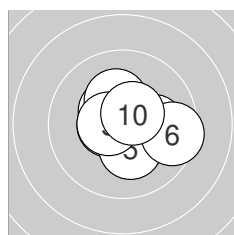
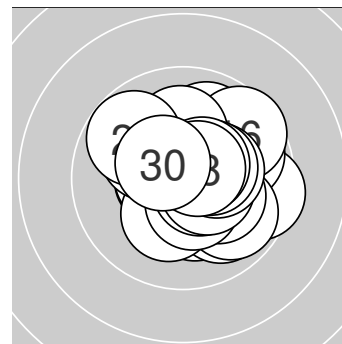

**Serie 1:**

10.1 →	10.6 *	10.6 *	10.8 *	10.3 *
9.5 →	10.4 *	10.3 *	10.6 *	10.5 *

beste Teiler: 38.0 (4.), 98.0 (9.), 98.3 (2.)  
 Trefferlage: 0.46 mm rechts, 0.00 mm  
 Streuwert: 1.23, horizontal: 1.46, vertikal: 0.94

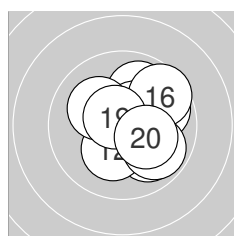

**Serie 2:**

10.0 ↘	10.2 *	9.9 ↗	10.5 *	9.8 ↗
9.6 ↗	9.9 ↘	10.1 ↖	10.6 *	10.2 *

beste Teiler: 79.2 (19.), 122.3 (14.), 181.2 (12.)  
 Trefferlage: 0.99 mm rechts, 0.22 mm hoch  
 Streuwert: 1.53, horizontal: 1.49, vertikal: 1.57

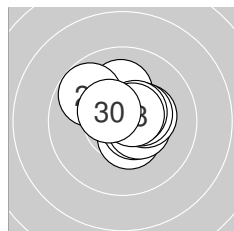

**Serie 3:**

10.5 *	10.1 ↑	10.6 *	10.5 *	10.3 *
10.4 *	10.5 *	10.6 *	9.8 ↘	10.5 *

beste Teiler: 83.2 (28.), 92.7 (23.), 109.8 (27.)  
 Trefferlage: 0.34 mm rechts, 0.46 mm hoch  
 Streuwert: 1.10, horizontal: 1.18, vertikal: 1.00



Ergebnis: **302.9** (290)  
 Serien: 100.1 102.1 100.7  
 Zähler: 20 10 0 0 0 0 0 0 0 0  
 Innenzehner: 11  
 Weitestе: 317 (30.), 312 (3.), 298 (16.)  
 beste Teiler: 55.3 (20.), 138.8 (23.), 144.1 (2.)  
 Trefferlage: 0.04 mm links, 0.18 mm tief  
 Streuwert: 1.62, horizontal: 1.57, vertikal: 1.66

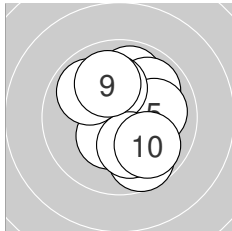
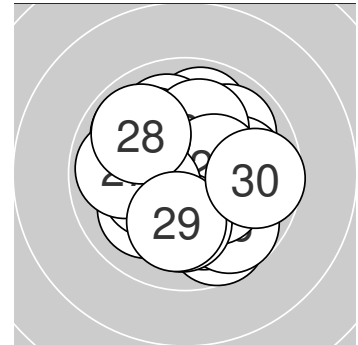

**Serie 1:**

9.9 ↗	10.4 *	9.7 ↘	9.9 ↗	10.0 →
10.2 *	10.2 *	9.9 ↘	10.0 ↗	9.9 ↘

beste Teiler: 144.1 (2.), 200.2 (7.), 200.4 (6.)  
 Trefferlage: 0.50 mm rechts, 0.29 mm hoch  
 Streuwert: 1.76, horizontal: 1.43, vertikal: 2.04

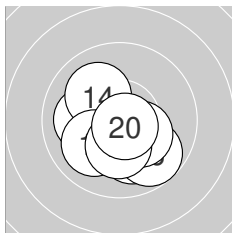

**Serie 2:**

10.1 ↘	10.4 *	10.1 ←	10.1 ↘	10.3 *
9.8 ↘	10.3 *	10.0 ↗	10.3 *	10.7 *

beste Teiler: 55.3 (20.), 148.3 (12.), 164.5 (17.)  
 Trefferlage: 0.09 mm links, 0.98 mm tief  
 Streuwert: 1.30, horizontal: 1.42, vertikal: 1.16

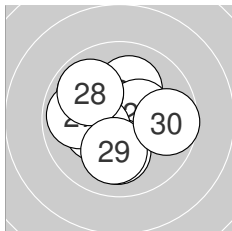

**Serie 3:**

10.3 *	10.1 ↗	10.4 *	9.9 ↘	10.1 ↓
10.3 *	9.9 ←	9.9 ↘	10.1 ↓	9.7 →

beste Teiler: 138.8 (23.), 163.2 (26.), 171.8 (21.)  
 Trefferlage: 0.52 mm links, 0.13 mm hoch  
 Streuwert: 1.67, horizontal: 1.82, vertikal: 1.50



Ergebnis: **300.3** (285)  
 Serien: 100.0 101.1 99.2  
 Zähler: 15 15 0 0 0 0 0 0 0  
 Innenzehner: 12  
 Weitestе: 470 (13.), 436 (26.), 376 (6.)  
 beste Teiler: 40.1 (16.), 60.6 (17.), 67.6 (19.)  
 Trefferlage: 0.50 mm links, 0.36 mm tief  
 Streuwert: 1.83, horizontal: 2.16, vertikal: 1.42

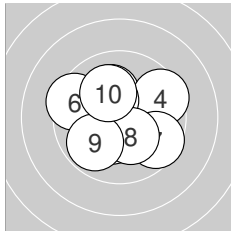
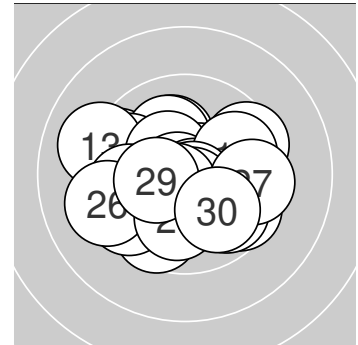

**Serie 1:**

10.1 ↖	10.3 *	10.6 *	9.5 ↗	10.3 *
9.4 ↙	9.6 ↘	10.3 *	9.8 ↘	10.1 ↖

beste Teiler: 76.9 (3.), 152.2 (5.), 155.8 (2.)  
 Trefferlage: 0.15 mm links, 0.19 mm hoch  
 Streuwert: 1.86, horizontal: 2.05, vertikal: 1.65

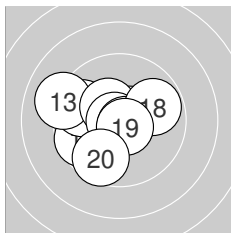

**Serie 2:**

9.7 ↙	9.7 ↙	9.1 ↙	10.6 *	10.4 *
10.8 *	10.7 *	9.8 ↗	10.7 *	9.6 ↘

beste Teiler: 40.1 (16.), 60.6 (17.), 67.6 (19.)  
 Trefferlage: 0.88 mm links, 0.03 mm tief  
 Streuwert: 1.78, horizontal: 2.11, vertikal: 1.37

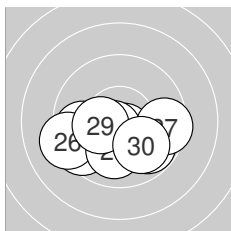

**Serie 3:**

10.6 *	9.8 ↘	10.6 *	9.8 ↙	9.5 ↙
9.2 ↙	9.5 →	10.0 ↓	10.3 *	9.9 ↘

beste Teiler: 82.8 (23.), 89.6 (21.), 153.3 (29.)  
 Trefferlage: 0.46 mm links, 1.24 mm tief  
 Streuwert: 1.82, horizontal: 2.46, vertikal: 0.75



Ergebnis: **311.7** (300)  
 Serien: 104.5 103.9 103.3  
 Zähler: 30 0 0 0 0 0 0 0 0 0  
 Innenzehner: 26  
 Weitesten: 218 (1.), 216 (25.), 209 (18.)  
 beste Teiler: 64.7 (7.), 65.3 (4.), 74.2 (8.)  
 Trefferlage: 0.22 mm links, 0.20 mm tief  
 Streuwert: 1.04, horizontal: 1.13, vertikal: 0.94

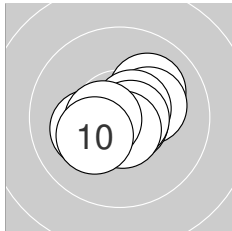
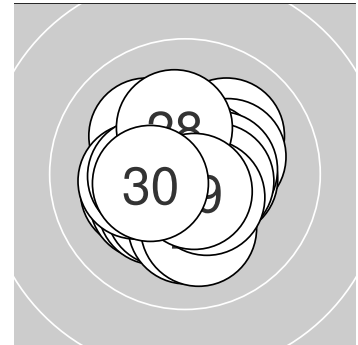

**Serie 1:**

10.1 ↗	10.5 *	10.2 *	10.7 *	10.2 *
10.6 *	10.7 *	10.7 *	10.6 *	10.2 *

beste Teiler: 64.7 (7.), 65.3 (4.), 74.2 (8.)  
 Trefferlage: 0.01 mm rechts, 0.09 mm tief  
 Streuwert: 1.04, horizontal: 1.26, vertikal: 0.78

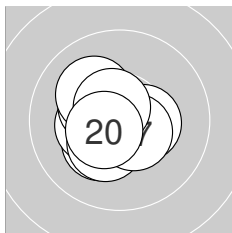

**Serie 2:**

10.3 *	10.3 *	10.4 *	10.3 *	10.6 *
10.3 *	10.5 *	10.1 ↘	10.6 *	10.5 *

beste Teiler: 85.9 (15.), 88.3 (19.), 106.5 (20.)  
 Trefferlage: 0.60 mm links, 0.06 mm tief  
 Streuwert: 0.96, horizontal: 0.97, vertikal: 0.95

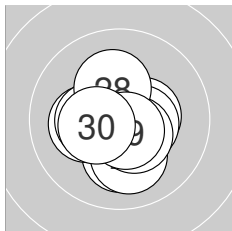

**Serie 3:**

10.4 *	10.1 ↓	10.5 *	10.2 *	10.1 ↓
10.5 *	10.3 *	10.2 *	10.6 *	10.4 *

beste Teiler: 76.0 (29.), 123.0 (23.), 123.7 (26.)  
 Trefferlage: 0.08 mm links, 0.46 mm tief  
 Streuwert: 1.14, horizontal: 1.16, vertikal: 1.11



**Ergebnis:** 303.7 (292)  
**Serien:** 100.1 101.8 101.8  
**Zähler:** 22 8 0 0 0 0 0 0 0  
**Innenzehner:** 15  
**Weiteste:** 482 (15.), 453 (7.), 431 (6.)  
**beste Teiler:** 47.5 (19.), 54.5 (14.), 84.5 (28.)  
**Trefferlage:** 1.17 mm links, 0.16 mm hoch  
**Streuwert:** 1.47, horizontal: 1.57, vertikal: 1.37

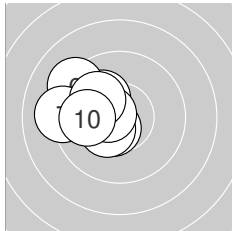
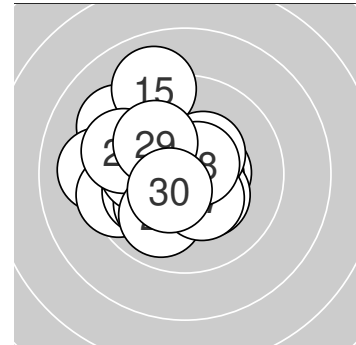

**Serie 1:**

10.5 *	10.1 ↘	10.5 *	10.4 *	9.7 ↘
9.2 ↘	9.1 ←	10.6 *	10.1 ↘	9.9 ←

**beste Teiler:** 93.4 (8.), 101.8 (3.), 122.0 (1.)  
**Trefferlage:** 1.99 mm links, 0.50 mm hoch  
**Streuwert:** 1.22, horizontal: 1.29, vertikal: 1.15

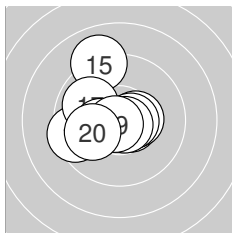

**Serie 2:**

10.6 *	10.4 *	10.6 *	10.7 *	9.0 ↗
9.5 ←	9.9 ↘	10.3 *	10.8 *	10.0 ←

**beste Teiler:** 47.5 (19.), 54.5 (14.), 89.1 (11.)  
**Trefferlage:** 0.81 mm links, 0.21 mm hoch  
**Streuwert:** 1.64, horizontal: 1.64, vertikal: 1.64

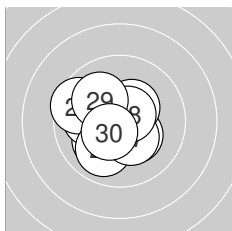

**Serie 3:**

10.1 ↗	10.0 ←	10.3 *	9.6 ↘	10.4 *
10.0 ↗	10.3 *	10.6 *	10.0 ↘	10.5 *

**beste Teiler:** 84.5 (28.), 118.1 (30.), 144.4 (25.)  
**Trefferlage:** 0.70 mm links, 0.21 mm tief  
**Streuwert:** 1.44, horizontal: 1.55, vertikal: 1.33



Ergebnis: **304.1** (291)  
 Serien: 102.3 101.3 100.5  
 Zähler: 21 9 0 0 0 0 0 0 0 0  
 Innenzehner: 17  
 Weitesten: 495 (15.), 443 (27.), 368 (26.)  
 beste Teiler: 35.2 (10.), 87.4 (16.), 95.1 (8.)  
 Trefferlage: 0.12 mm rechts, 0.75 mm hoch  
 Streuwert: 1.58, horizontal: 1.87, vertikal: 1.22

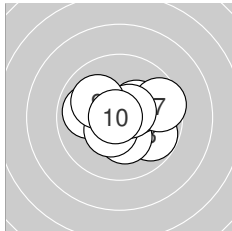
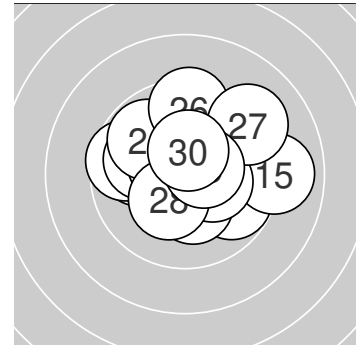

**Serie 1:**

10.5 *	9.9 ←	9.8 ↘	10.3 *	10.3 *
10.4 *	9.6 →	10.6 *	10.1 ↙	10.8 *

beste Teiler: 35.2 (10.), 95.1 (8.), 101.0 (1.)  
 Trefferlage: 0.41 mm rechts, 0.01 mm hoch  
 Streuwert: 1.49, horizontal: 1.83, vertikal: 1.04

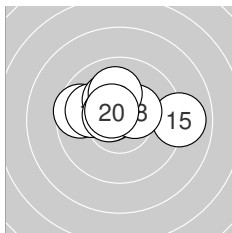

**Serie 2:**

9.6 ←	10.0 ←	10.3 *	10.2 *	9.0 →
10.6 *	10.6 *	10.4 *	10.1 ↑	10.5 *

beste Teiler: 87.4 (16.), 97.9 (17.), 101.4 (20.)  
 Trefferlage: 0.32 mm links, 0.96 mm hoch  
 Streuwert: 1.63, horizontal: 2.21, vertikal: 0.68

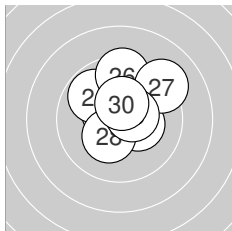

**Serie 3:**

10.5 *	9.9 ↗	10.1 ↘	9.8 ↘	10.3 *
9.5 ↑	9.2 ↗	10.3 *	10.5 *	10.4 *

beste Teiler: 111.0 (29.), 114.2 (21.), 132.2 (30.)  
 Trefferlage: 0.29 mm rechts, 1.28 mm hoch  
 Streuwert: 1.59, horizontal: 1.66, vertikal: 1.52



Ergebnis: **311.8** (298)  
 Serien: 102.3 104.0 105.5  
 Zähler: 28 2 0 0 0 0 0 0 0 0  
 Innenzehner: 25  
 Weitest: 329 (8.), 291 (11.), 223 (6.)  
 beste Teiler: 23.7 (9.), 53.2 (23.), 58.9 (15.)  
 Trefferlage: 0.09 mm rechts, 0.26 mm tief  
 Streuwert: 1.10, horizontal: 1.12, vertikal: 1.08

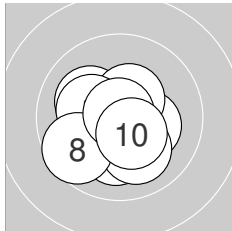
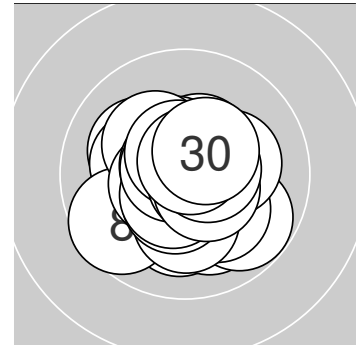

**Serie 1:**

10.2 *	10.3 *	10.1 ↓	10.1 ↖	10.4 *
10.1 ↘	10.2 *	9.6 ↙	10.9 *	10.4 *

beste Teiler: 23.7 (9.), 127.4 (10.), 127.9 (5.)  
 Trefferlage: 0.28 mm links, 0.64 mm tief  
 Streuwert: 1.34, horizontal: 1.40, vertikal: 1.28

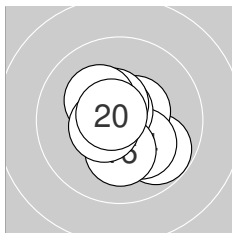

**Serie 2:**

9.8 ↘	10.7 *	10.5 *	10.2 *	10.7 *
10.2 *	10.5 *	10.2 *	10.5 *	10.7 *

beste Teiler: 58.9 (15.), 61.8 (20.), 66.4 (12.)  
 Trefferlage: 0.20 mm rechts, 0.19 mm tief  
 Streuwert: 1.14, horizontal: 1.10, vertikal: 1.17

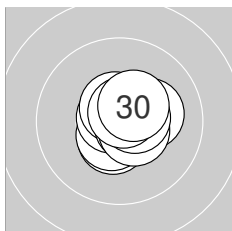

**Serie 3:**

10.5 *	10.6 *	10.7 *	10.2 *	10.6 *
10.7 *	10.5 *	10.6 *	10.7 *	10.4 *

beste Teiler: 53.2 (23.), 60.0 (29.), 71.6 (26.)  
 Trefferlage: 0.37 mm rechts, 0.04 mm hoch  
 Streuwert: 0.76, horizontal: 0.79, vertikal: 0.72



**Ergebnis: 309.6 (298)**  
**Serien: 101.2 104.0 104.4**  
**Zähler: 28 2 0 0 0 0 0 0 0 0**  
**Innenzehner: 23**  
**Weiteste: 436 (8.), 430 (5.), 245 (28.)**  
**beste Teiler: 5.6 (10.), 38.6 (24.), 58.0 (1.)**  
**Trefferlage: 0.16 mm rechts, 0.44 mm tief**  
**Streuwert: 1.28, horizontal: 1.33, vertikal: 1.22**

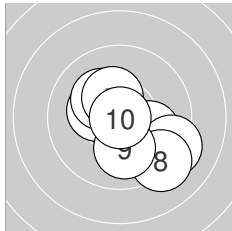
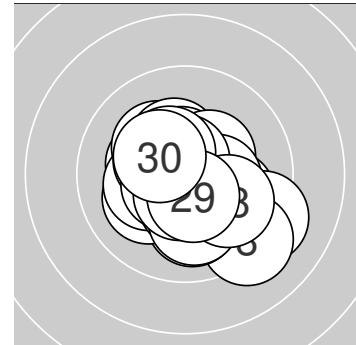

**Serie 1:**

10.7 *	10.4 *	10.3 *	10.0 ↘	9.2 ↘
10.2 *	10.3 *	9.2 ↘	10.0 ↓	10.9 *

**beste Teiler: 5.6 (10.), 58.0 (1.), 141.4 (2.)**  
**Trefferlage: 0.62 mm rechts, 0.72 mm tief**  
**Streuwert: 1.67, horizontal: 1.79, vertikal: 1.54**

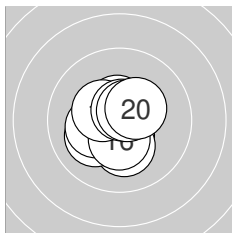

**Serie 2:**

10.5 *	10.2 *	10.1 ↙	10.2 *	10.5 *
10.4 *	10.4 *	10.7 *	10.6 *	10.4 *

**beste Teiler: 75.7 (18.), 88.8 (19.), 104.5 (15.)**  
**Trefferlage: 0.24 mm links, 0.18 mm tief**  
**Streuwert: 1.05, horizontal: 1.00, vertikal: 1.10**

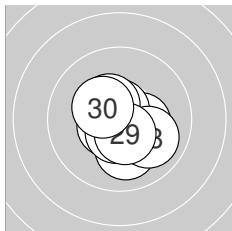

**Serie 3:**

10.1 ↓	10.6 *	10.3 *	10.8 *	10.7 *
10.4 *	10.6 *	10.0 ↘	10.5 *	10.4 *

**beste Teiler: 38.6 (24.), 66.3 (25.), 98.9 (22.)**  
**Trefferlage: 0.10 mm rechts, 0.40 mm tief**  
**Streuwert: 1.04, horizontal: 1.04, vertikal: 1.03**





**Ergebnis: 303.9 (292)**  
**Serien: 101.2 100.8 101.9**  
**Zähler: 23 6 1 0 0 0 0 0 0 0**  
**Innenzehner: 21**  
**Weiteste: 501 (28.), 479 (11.), 465 (10.)**  
**beste Teiler: 49.3 (30.), 80.8 (12.), 89.0 (1.)**  
**Trefferlage: 0.70 mm rechts, 0.43 mm tief**  
**Streuwert: 1.59, horizontal: 1.86, vertikal: 1.26**

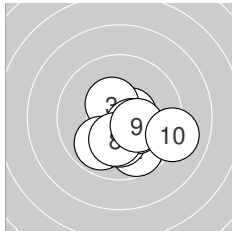
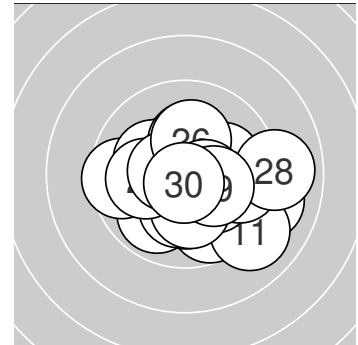

**Serie 1:**

10.6 *	9.7 ↘	10.4 *	9.9 ✓	10.2 *
10.3 *	10.5 *	10.2 *	10.3 *	9.1 →

**beste Teiler: 89.0 (1.), 123.9 (7.), 128.1 (3.)**  
**Trefferlage: 0.80 mm rechts, 1.10 mm tief**  
**Streuwert: 1.42, horizontal: 1.63, vertikal: 1.16**

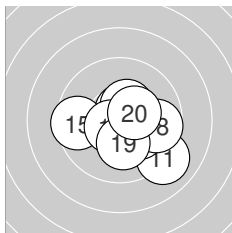

**Serie 2:**

9.0 ↘	10.6 *	10.2 *	10.2 *	9.5 ←
10.4 *	10.6 *	9.7 →	10.2 *	10.4 *

**beste Teiler: 80.8 (12.), 90.6 (17.), 132.3 (16.)**  
**Trefferlage: 0.78 mm rechts, 0.58 mm tief**  
**Streuwert: 1.69, horizontal: 2.00, vertikal: 1.30**

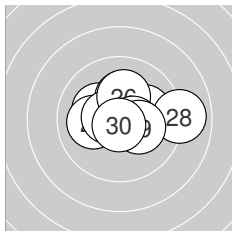

**Serie 3:**

10.2 *	10.2 *	10.1 ←	10.1 →	10.6 *
10.2 *	10.5 *	8.9 →	10.3 *	10.8 *

**beste Teiler: 49.3 (30.), 98.6 (25.), 115.5 (27.)**  
**Trefferlage: 0.53 mm rechts, 0.38 mm hoch**  
**Streuwert: 1.61, horizontal: 2.09, vertikal: 0.91**



**Ergebnis:** 306.4 (295)  
**Serien:** 100.5 104.1 101.8  
**Zähler:** 25 5 0 0 0 0 0 0 0  
**Innenzehner:** 19  
**Weiteste:** 422 (1.), 397 (6.), 395 (28.)  
**beste Teiler:** 12.6 (11.), 25.0 (19.), 56.0 (2.)  
**Trefferlage:** 0.51 mm links, 0.29 mm hoch  
**Streuwert:** 1.47, horizontal: 1.68, vertikal: 1.23

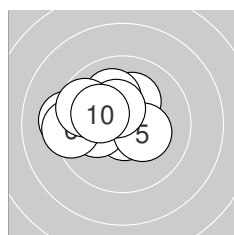
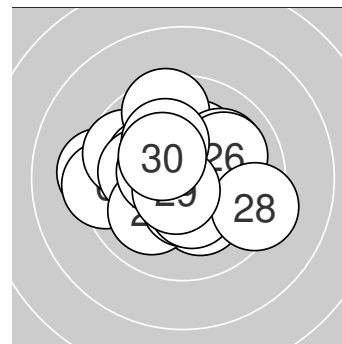

**Serie 1:**

9.3 ←	10.7 *	10.2 *	10.2 *	10.3 *
9.4 ←	10.1 ↗	10.4 *	9.7 ↖	10.2 *

**beste Teiler:** 56.0 (2.), 129.6 (8.), 164.7 (5.)  
**Trefferlage:** 1.36 mm links, 0.55 mm hoch  
**Streuwert:** 1.53, horizontal: 1.93, vertikal: 0.98

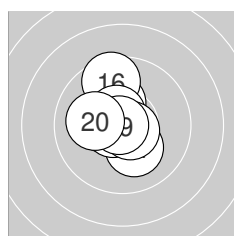

**Serie 2:**

10.9 *	10.3 *	10.2 *	10.2 *	10.6 *
9.6 ↗	10.6 *	10.7 *	10.9 *	10.1 ←

**beste Teiler:** 12.6 (11.), 25.0 (19.), 71.8 (18.)  
**Trefferlage:** 0.49 mm links, 0.39 mm hoch  
**Streuwert:** 1.15, horizontal: 0.91, vertikal: 1.36

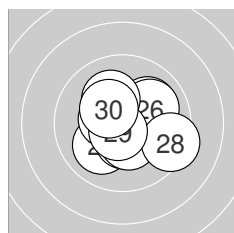

**Serie 3:**

10.0 ↘	10.0 ↗	10.4 *	10.4 *	10.5 *
10.0 ↗	10.1 ↗	9.4 ↘	10.7 *	10.3 *

**beste Teiler:** 71.1 (29.), 120.6 (25.), 127.3 (23.)  
**Trefferlage:** 0.31 mm rechts, 0.06 mm tief  
**Streuwert:** 1.55, horizontal: 1.72, vertikal: 1.35



Ergebnis: **310.7** (298)  
 Serien: 104.6 103.0 103.1  
 Zähler: 28 2 0 0 0 0 0 0 0 0  
 Innenzehner: 25  
 Weitesten: 366 (30.), 252 (9.), 234 (26.)  
 beste Teiler: 58.0 (11.), 60.8 (3.), 64.0 (22.)  
 Trefferlage: 0.09 mm links, 0.01 mm hoch  
 Streuwert: 1.17, horizontal: 1.16, vertikal: 1.19

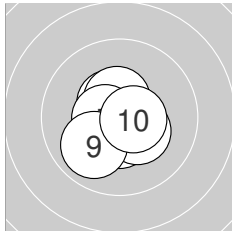
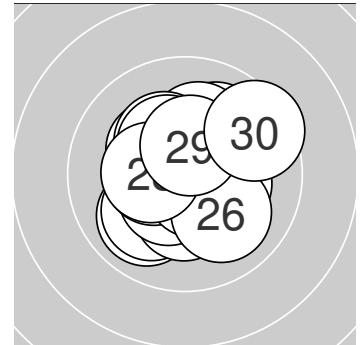

**Serie 1:**

10.5 *	10.5 *	10.7 *	10.5 *	10.5 *
10.5 *	10.6 *	10.3 *	9.9 ↙	10.6 *

beste Teiler: 60.8 (3.), 93.0 (10.), 97.1 (7.)  
 Trefferlage: 0.27 mm links, 0.36 mm tief  
 Streuwert: 0.92, horizontal: 0.85, vertikal: 0.99

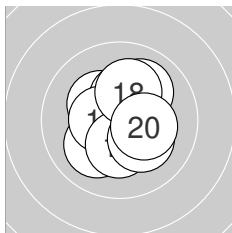

**Serie 2:**

10.7 *	10.3 *	10.0 ↗	10.1 ↙	10.4 *
10.5 *	10.3 *	10.2 *	10.2 *	10.3 *

beste Teiler: 58.0 (11.), 118.1 (16.), 150.3 (15.)  
 Trefferlage: 0.06 mm rechts, 0.14 mm hoch  
 Streuwert: 1.29, horizontal: 1.18, vertikal: 1.38

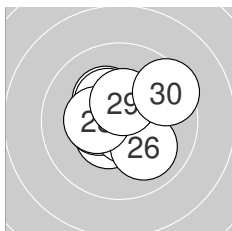

**Serie 3:**

10.5 *	10.7 *	10.3 *	10.4 *	10.7 *
10.0 ↘	10.3 *	10.3 *	10.4 *	9.5 ↗

beste Teiler: 64.0 (22.), 75.6 (25.), 119.6 (21.)  
 Trefferlage: 0.05 mm links, 0.27 mm hoch  
 Streuwert: 1.33, horizontal: 1.46, vertikal: 1.18



Ergebnis: **309.2** (294)  
 Serien: 102.3 105.0 101.9  
 Zähler: 24 6 0 0 0 0 0 0 0 0  
 Innenzehner: 20  
 Weitesten: 334 (1.), 276 (25.), 272 (6.)  
 beste Teiler: 49.2 (3.), 52.1 (18.), 65.0 (13.)  
 Trefferlage: 0.24 mm rechts, 0.16 mm tief  
 Streuwert: 1.28, horizontal: 1.42, vertikal: 1.13

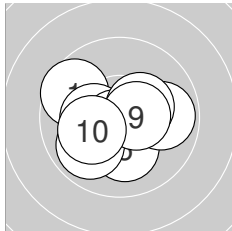
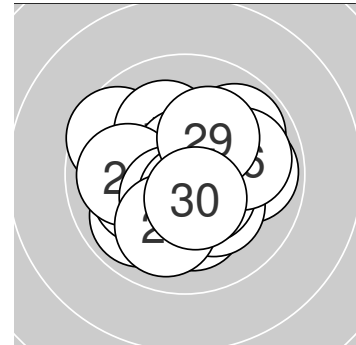

**Serie 1:**

9.6 ↖	10.3 *	10.8 *	10.6 *	10.1 ↓
9.9 →	10.4 *	9.9 ↗	10.5 *	10.2 *

beste Teiler: 49.2 (3.), 79.4 (4.), 110.3 (9.)  
 Trefferlage: 0.28 mm links, 0.33 mm tief  
 Streuwert: 1.47, horizontal: 1.78, vertikal: 1.08

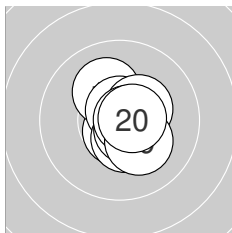

**Serie 2:**

10.7 *	10.1 ↘	10.7 *	10.5 *	10.5 *
10.4 *	10.6 *	10.7 *	10.2 *	10.6 *

beste Teiler: 52.1 (18.), 65.0 (13.), 74.4 (11.)  
 Trefferlage: 0.46 mm rechts, 0.11 mm tief  
 Streuwert: 0.85, horizontal: 0.67, vertikal: 1.00

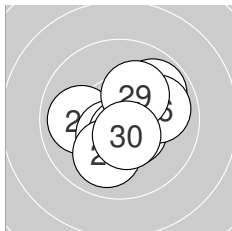

**Serie 3:**

10.5 *	10.0 ←	10.5 *	9.9 ↗	9.8 ↗
9.9 →	10.6 *	10.0 ↓	10.2 *	10.5 *

beste Teiler: 96.1 (27.), 115.5 (30.), 117.5 (21.)  
 Trefferlage: 0.53 mm rechts, 0.04 mm tief  
 Streuwert: 1.47, horizontal: 1.55, vertikal: 1.38



**Ergebnis:** **307.7** (291)  
**Serien:** 104.5 100.5 102.7  
**Zähler:** 21 9 0 0 0 0 0 0 0 0  
**Innenzehner:** 15  
**Weiteste:** 386 (19.), 335 (13.), 327 (1.)  
**beste Teiler:** 19.9 (10.), 20.0 (23.), 29.1 (8.)  
**Trefferlage:** 0.57 mm links, 0.13 mm tief  
**Streuwert:** 1.42, horizontal: 1.73, vertikal: 1.02

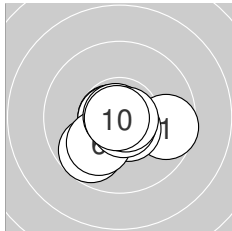
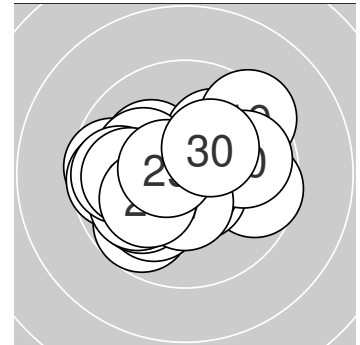

**Serie 1:**

9.6 →	9.7 ↙	10.7 *	10.7 *	10.6 *
10.0 ↙	10.7 *	10.8 *	10.8 *	10.9 *

**beste Teiler:** 19.9 (10.), 29.1 (8.), 45.5 (9.)  
**Trefferlage:** 0.06 mm links, 0.62 mm tief  
**Streuwert:** 1.15, horizontal: 1.41, vertikal: 0.80

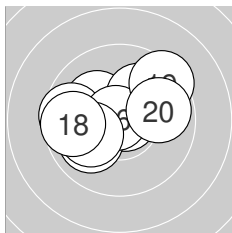

**Serie 2:**

10.8 *	10.2 *	9.6 ←	10.0 ↙	10.1 ↗
10.8 *	10.1 ↙	9.7 ←	9.4 ↗	9.8 →

**beste Teiler:** 30.8 (16.), 39.2 (11.), 195.6 (12.)  
**Trefferlage:** 0.50 mm links, 0.40 mm hoch  
**Streuwert:** 1.82, horizontal: 2.28, vertikal: 1.19

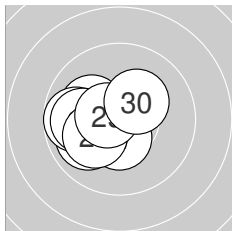

**Serie 3:**

10.1 ↖	10.8 *	10.9 *	9.9 ↙	9.7 ←
9.9 ←	10.4 *	10.1 ↙	10.6 *	10.3 *

**beste Teiler:** 20.0 (23.), 39.4 (22.), 88.8 (29.)  
**Trefferlage:** 1.14 mm links, 0.17 mm tief  
**Streuwert:** 1.12, horizontal: 1.33, vertikal: 0.85



Ergebnis: **291.3** (279)  
 Serien: 91.7 102.6 97.0  
 Zähler: 14 11 5 0 0 0 0 0 0 0  
 Innenzehner: 11  
 Weitestе: 680 (10.), 632 (5.), 573 (6.)  
 beste Teiler: 71.1 (11.), 72.2 (1.), 103.7 (15.)  
 Trefferlage: 0.59 mm links, 0.20 mm tief  
 Streuwert: 2.53, horizontal: 2.53, vertikal: 2.53

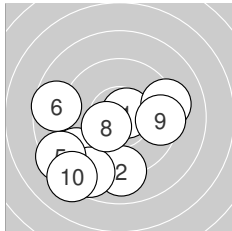
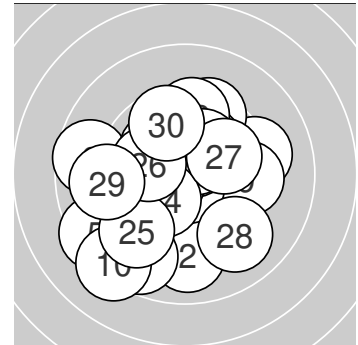

**Serie 1:**

10.7 *	9.0 ↓	8.9 ↙	8.7 ↙	8.4 ↙
8.7 ←	9.2 →	10.4 *	9.5 →	8.2 ↙

beste Teiler: 72.2 (1.), 144.8 (8.), 366.8 (9.)  
 Trefferlage: 1.43 mm links, 2.02 mm tief  
 Streuwert: 3.09, horizontal: 3.53, vertikal: 2.58

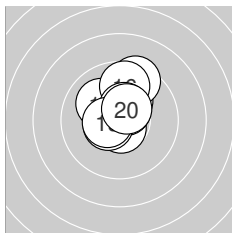

**Serie 2:**

10.7 *	10.2 *	9.4 ↑	10.1 ↘	10.5 *
9.7 ↑	10.5 *	10.5 *	10.5 *	10.5 *

beste Teiler: 71.1 (11.), 103.7 (15.), 110.8 (19.)  
 Trefferlage: 0.05 mm rechts, 1.14 mm hoch  
 Streuwert: 1.20, horizontal: 0.98, vertikal: 1.39

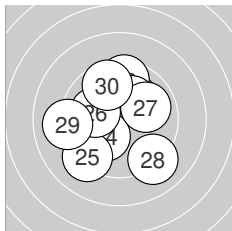

**Serie 3:**

10.1 ↗	9.5 ↑	10.2 *	10.2 *	9.2 ↙
10.0 ←	9.9 →	9.1 ↘	9.1 ←	9.7 ↖

beste Teiler: 195.5 (23.), 199.3 (24.), 216.3 (21.)  
 Trefferlage: 0.41 mm links, 0.27 mm hoch  
 Streuwert: 2.45, horizontal: 2.43, vertikal: 2.47



**Ergebnis:** **304.2** (290)  
**Serien:** 98.8 103.5 101.9  
**Zähler:** 21 8 1 0 0 0 0 0 0 0  
**Innenzehner:** 17  
**Weiteste:** 539 (5.), 378 (10.), 323 (25.)  
**beste Teiler:** 23.3 (20.), 37.6 (15.), 79.1 (27.)  
**Trefferlage:** 0.22 mm links, 0.22 mm tief  
**Streuwert:** 1.63, horizontal: 1.82, vertikal: 1.40

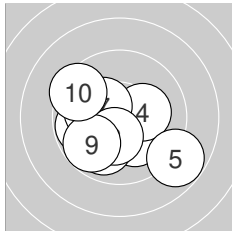
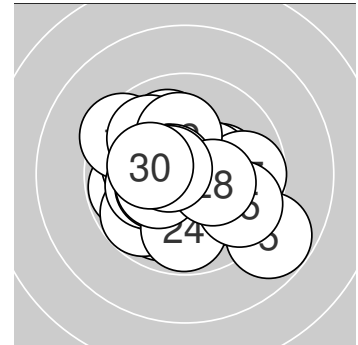

**Serie 1:**

10.2 *	9.8 ←	9.9 ↙	10.2 *	8.8 ↘
10.1 ←	10.3 *	10.3 *	9.8 ↙	9.4 ↖

**beste Teiler:** 153.9 (7.), 154.2 (8.), 183.1 (4.)  
**Trefferlage:** 0.58 mm links, 0.75 mm tief  
**Streuwert:** 2.04, horizontal: 2.38, vertikal: 1.63

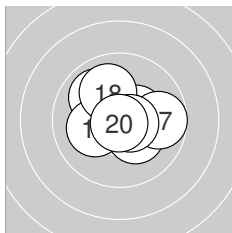

**Serie 2:**

10.0 ↘	10.2 *	10.4 *	10.6 *	10.8 *
10.3 *	9.7 →	10.0 ↖	10.6 *	10.9 *

**beste Teiler:** 23.3 (20.), 37.6 (15.), 84.4 (19.)  
**Trefferlage:** 0.29 mm rechts, 0.18 mm hoch  
**Streuwert:** 1.30, horizontal: 1.51, vertikal: 1.04

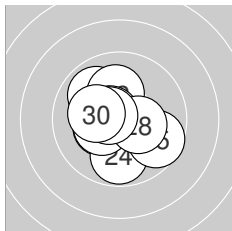

**Serie 3:**

9.9 ↘	10.1 ↑	10.3 *	9.8 ↓	9.7 ↘
10.4 *	10.6 *	10.3 *	10.6 *	10.2 *

**beste Teiler:** 79.1 (27.), 87.5 (29.), 148.7 (26.)  
**Trefferlage:** 0.40 mm links, 0.10 mm tief  
**Streuwert:** 1.48, horizontal: 1.50, vertikal: 1.46



Ergebnis: **283.9** (269)  
 Serien: 94.4 94.1 95.4  
 Zähler: 7 16 6 1 0 0 0 0 0 0  
 Innenzehner: 6  
 Weitester: 3072 (22.), 2144 (13.), 2131 (12.)  
 beste Teiler: 261.0 (27.), 283.3 (4.), 362.5 (18.)  
 Trefferlage: 5.47 mm rechts, 0.43 mm tief  
 Streuwert: 8.86, horizontal: 6.74, vertikal: 10.56

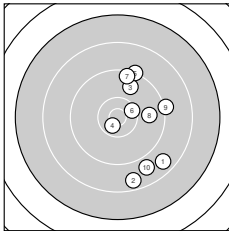
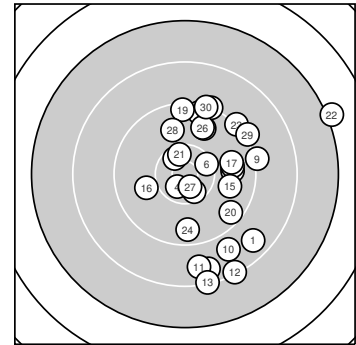

**Serie 1:**

8.6 ↘	8.6 ↓	9.8 ↑	10.6 *	9.2 ↑
10.4 *	9.4 ↑	9.8 →	9.2 →	8.8 ↘

beste Teiler: 283.3 (4.), 463.0 (6.), 925.2 (8.)  
 Trefferlage: 6.37 mm rechts, 0.89 mm tief  
 Streuwert: 8.57, horizontal: 4.82, vertikal: 11.12

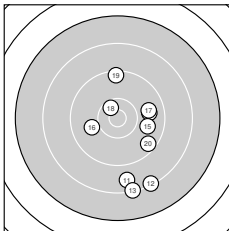

**Serie 2:**

8.7 ↓	8.3 ↘	8.3 ↓	9.8 →	9.8 →
10.0 ←	9.8 →	10.5 *	9.4 ↑	9.5 ↘

beste Teiler: 362.5 (18.), 793.2 (16.), 903.1 (15.)  
 Trefferlage: 4.26 mm rechts, 5.09 mm tief  
 Streuwert: 8.90, horizontal: 5.96, vertikal: 11.08

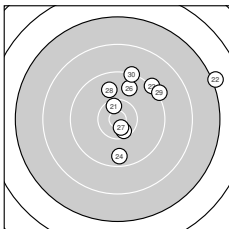

**Serie 3:**

10.5 *	7.1 →	9.2 ↗	9.6 ↓	10.5 *
9.7 ↑	10.6 *	9.8 ↑	9.2 ↗	9.2 ↑

beste Teiler: 261.0 (27.), 383.7 (25.), 397.9 (21.)  
 Trefferlage: 5.79 mm rechts, 4.67 mm hoch  
 Streuwert: 8.50, horizontal: 9.21, vertikal: 7.74





Ergebnis: **296.7** (284)  
 Serien: 94.5 99.7 102.5  
 Zähler: 16 12 2 0 0 0 0 0 0 0  
 Innenzehner: 8  
 Weitester: 1984 (2.), 1715 (1.), 1538 (5.)  
 beste Teiler: 146.0 (10.), 175.6 (19.), 232.1 (23.)  
 Trefferlage: 0.13 mm rechts, 2.16 mm hoch  
 Streuwert: 6.92, horizontal: 4.55, vertikal: 8.66

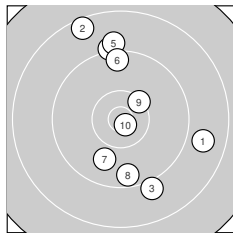
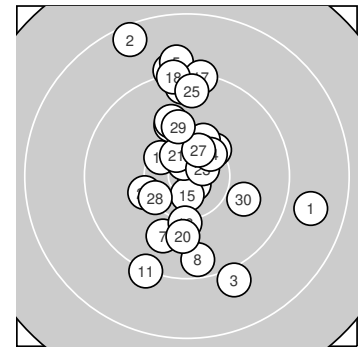

**Serie 1:**  
 8.8 → 8.5 ↖ 9.0 ↘ 9.2 ↑ 9.0 ↑  
 9.5 ↑ 9.9 ↙ 9.5 ↓ 10.3 ↗ 10.8 \*  
 beste Teiler: 146.0 (10.), 511.4 (9.), 864.2 (7.)  
 Trefferlage: 1.38 mm rechts, 2.46 mm hoch  
 Streuwert: 9.60, horizontal: 6.58, vertikal: 11.87

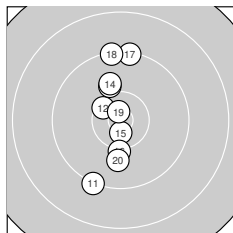

**Serie 2:**  
 9.2 ↙ 10.4 \* 10.1 ↖ 10.0 ↑ 10.6 \*  
 10.2 ↓ 9.3 ↑ 9.3 ↑ 10.7 \* 9.9 ↓  
 beste Teiler: 175.6 (19.), 250.0 (15.), 431.1 (12.)  
 Trefferlage: 1.45 mm links, 1.53 mm hoch  
 Streuwert: 6.46, horizontal: 2.07, vertikal: 8.89

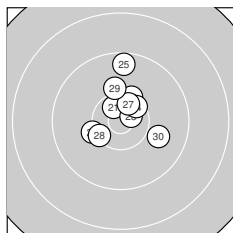

**Serie 3:**  
 10.6 \* 10.3 ↗ 10.7 \* 10.4 \* 9.5 ↑  
 10.2 ↖ 10.5 \* 10.3 ↙ 10.1 ↑ 9.9 →  
 beste Teiler: 232.1 (23.), 311.7 (21.), 381.3 (27.)  
 Trefferlage: 0.47 mm rechts, 2.48 mm hoch  
 Streuwert: 4.21, horizontal: 3.82, vertikal: 4.57



**Ergebnis:** 261.7 (250)  
**Serien:** 86.8 84.8 90.1  
**Zähler:** 4 11 8 5 2 0 0 0 0 0  
**Innenzehner:** 3  
**Weiteste:** 3640 (13.), 3543 (6.), 3118 (26.)  
**beste Teiler:** 185.8 (21.), 378.4 (27.), 427.0 (29.)  
**Trefferlage:** 7.40 mm rechts, 6.60 mm tief  
**Streuwert:** 12.35, horizontal: 13.46, vertikal: 11.13

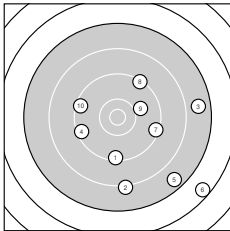
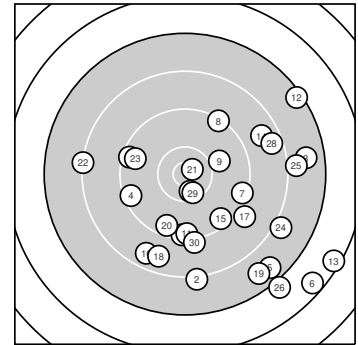

**Serie 1:**  
 9.3 ↓                      8.2 ↓                      7.7 →                      9.4 ←                      7.6 ↘  
 6.5 ↘                      9.4 ↘                      9.3 ↗                      10.0 →                      9.4 ←  
**beste Teiler:** 778.3 (9.), 1227.0 (10.), 1228.0 (4.)  
**Trefferlage:** 7.57 mm rechts, 6.52 mm tief  
**Streuwert:** 12.92, horizontal: 13.57, vertikal: 12.24

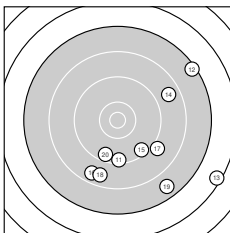

**Serie 2:**  
 9.4 ↓                      7.4 ↗                      6.4 ↘                      8.7 ↗                      9.4 ↘  
 8.6 ↙                      9.0 ↘                      8.7 ↓                      7.7 ↘                      9.5 ↓  
**beste Teiler:** 1149.3 (20.), 1206.9 (15.), 1257.6 (11.)  
**Trefferlage:** 8.98 mm rechts, 9.08 mm tief  
**Streuwert:** 12.65, horizontal: 13.23, vertikal: 12.04

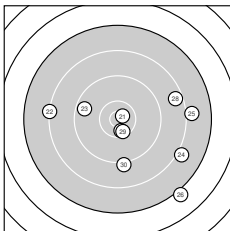

**Serie 3:**  
 10.7 \*                      8.2 ←                      9.6 ←                      8.0 ↘                      8.0 →  
 7.1 ↘                      10.5 \*                      8.5 →                      10.4 \*                      9.1 ↓  
**beste Teiler:** 185.8 (21.), 378.4 (27.), 427.0 (29.)  
**Trefferlage:** 5.64 mm rechts, 4.22 mm tief  
**Streuwert:** 12.45, horizontal: 14.79, vertikal: 9.56



Ergebnis: **292.1** (278)  
 Serien: 95.6 96.9 99.6  
 Zähler: 14 12 3 0 1 0 0 0 0 0  
 Innenzehner: 4  
 Weitester: 3346 (8.), 1869 (9.), 1679 (3.)  
 beste Teiler: 175.0 (16.), 289.0 (21.), 337.6 (22.)  
 Trefferlage: 0.40 mm links, 0.70 mm hoch  
 Streuwert: 8.27, horizontal: 6.66, vertikal: 9.62

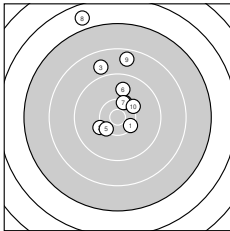
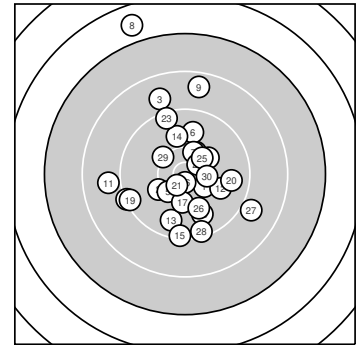

**Serie 1:**  
 10.3 ↘                      10.1 ↙                      8.9 ↑                      10.3 ↗                      10.3 ↘  
 9.8 ↑                      10.3 ↑                      6.8 ↑                      8.6 ↑                      10.2 ↗  
 beste Teiler: 486.8 (1.), 498.4 (7.), 517.6 (5.)  
 Trefferlage: 0.79 mm links, 7.79 mm hoch  
 Streuwert: 8.82, horizontal: 5.31, vertikal: 11.28

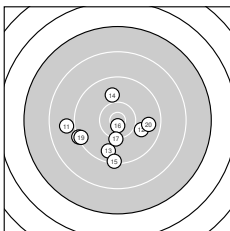

**Serie 2:**  
 8.9 ←                      9.9 →                      9.7 ↓                      9.9 ↑                      9.3 ↓  
 10.7 \*                      10.2 ↓                      9.3 ←                      9.3 ←                      9.7 →  
 beste Teiler: 175.0 (16.), 599.5 (17.), 812.4 (12.)  
 Trefferlage: 2.90 mm links, 3.94 mm tief  
 Streuwert: 7.14, horizontal: 8.39, vertikal: 5.62

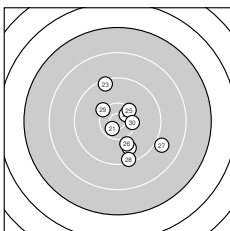

**Serie 3:**  
 10.6 \*                      10.5 \*                      9.4 ↑                      9.8 ↓                      10.3 ↗  
 10.0 ↓                      9.0 →                      9.4 ↓                      10.2 ↘                      10.4 \*  
 beste Teiler: 289.0 (21.), 337.6 (22.), 468.9 (30.)  
 Trefferlage: 2.48 mm rechts, 1.72 mm tief  
 Streuwert: 6.35, horizontal: 5.28, vertikal: 7.25



Ergebnis: **280.8** (269)  
 Serien: 92.4 93.1 95.3  
 Zähler: 11 9 8 2 0 0 0 0 0 0  
 Innenzehner: 4  
 Weitest: 3094 (6.), 2517 (19.), 2283 (2.)  
 beste Teiler: 126.0 (29.), 190.9 (23.), 354.5 (27.)  
 Trefferlage: 0.50 mm links, 1.29 mm tief  
 Streuwert: 10.66, horizontal: 4.90, vertikal: 14.25

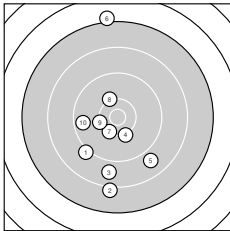
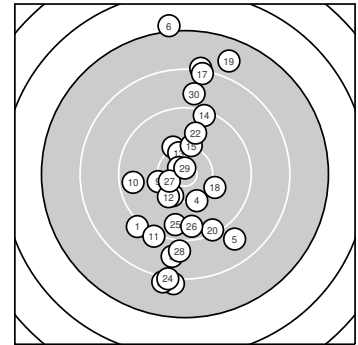

**Serie 1:**

9.1 ↙	8.1 ↓	8.8 ↓	10.2 ↓	8.8 ↘
7.1 ↑	10.3 ↘	10.2 ↗	10.2 ←	9.6 ←

beste Teiler: 515.4 (7.), 576.2 (9.), 603.4 (4.)  
 Trefferlage: 2.68 mm links, 4.09 mm tief  
 Streuwert: 11.29, horizontal: 5.97, vertikal: 14.80

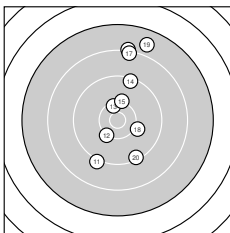

**Serie 2:**

9.2 ↘	10.2 ↘	10.4 *	9.4 ↑	10.2 ↑
8.2 ↑	8.3 ↑	10.1 ↘	7.8 ↑	9.3 ↓

beste Teiler: 462.3 (13.), 580.2 (12.), 605.3 (15.)  
 Trefferlage: 2.20 mm rechts, 5.69 mm hoch  
 Streuwert: 10.21, horizontal: 4.74, vertikal: 13.64

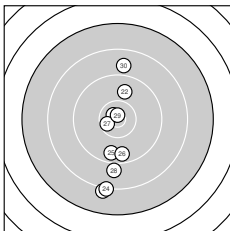

**Serie 3:**

8.1 ↓	9.9 ↑	10.7 *	8.2 ↓	9.6 ↓
9.6 ↓	10.5 *	9.0 ↓	10.8 *	8.9 ↑

beste Teiler: 126.0 (29.), 190.9 (23.), 354.5 (27.)  
 Trefferlage: 1.03 mm links, 5.48 mm tief  
 Streuwert: 9.29, horizontal: 2.38, vertikal: 12.93



Ergebnis: **302.5** (291)  
 Serien: 100.8 101.2 100.5  
 Zähler: 21 9 0 0 0 0 0 0 0 0  
 Innenzehner: 13  
 Weitester: 1537 (5.), 1486 (22.), 1341 (15.)  
 beste Teiler: 84.9 (4.), 232.1 (25.), 356.3 (18.)  
 Trefferlage: 0.24 mm rechts, 1.24 mm hoch  
 Streuwert: 5.66, horizontal: 5.88, vertikal: 5.42

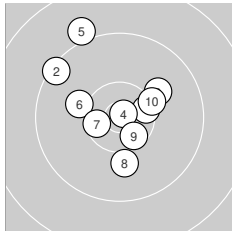
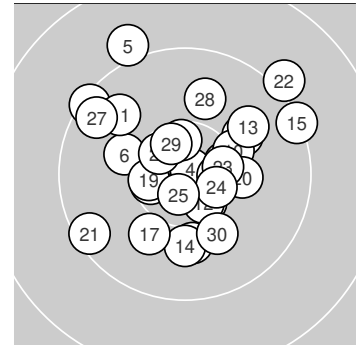

**Serie 1:**  
 10.4 \*                      9.3 ↘                      10.0 ↗  
 10.1 ↖                      10.5 \*                      10.0 ↓  
 beste Teiler: 84.9 (4.), 383.8 (9.), 388.4 (7.)  
 Trefferlage: 0.72 mm links, 2.07 mm hoch  
 Streuwert: 5.78, horizontal: 5.69, vertikal: 5.86

10.8 \*                      9.0 ↘  
 10.5 \*                      10.2 ↗

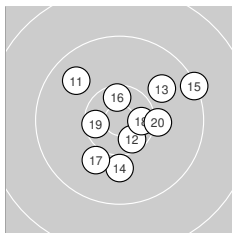

**Serie 2:**  
 9.8 ↘                      10.5 \*                      9.9 ↗  
 10.5 \*                      10.0 ↘                      10.5 \*  
 beste Teiler: 356.3 (18.), 371.3 (12.), 373.2 (16.)  
 Trefferlage: 1.56 mm rechts, 0.23 mm hoch  
 Streuwert: 5.46, horizontal: 5.86, vertikal: 5.03

10.0 ↓                      9.3 ↗  
 10.5 \*                      10.2 →

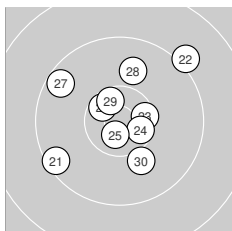

**Serie 3:**  
 9.4 ↙                      9.1 ↗                      10.4 \*  
 10.5 \*                      9.5 ↘                      9.9 ↑  
 beste Teiler: 232.1 (25.), 359.2 (26.), 363.4 (29.)  
 Trefferlage: 0.09 mm links, 1.43 mm hoch  
 Streuwert: 6.11, horizontal: 6.46, vertikal: 5.74

10.5 \*                      10.7 \*  
 10.5 \*                      10.0 ↘



Ergebnis: **295.1** (282)  
 Serien: 100.8 97.6 96.7  
 Zähler: 16 11 2 1 0 0 0 0 0 0  
 Innenzehner: 6  
 Weitesten: 2853 (18.), 2009 (30.), 1700 (29.)  
 beste Teiler: 132.9 (15.), 159.8 (24.), 285.8 (8.)  
 Trefferlage: 0.71 mm rechts, 0.31 mm hoch  
 Streuwert: 7.58, horizontal: 4.13, vertikal: 9.90

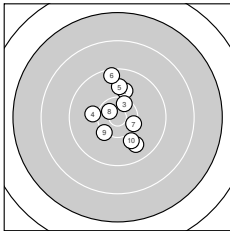
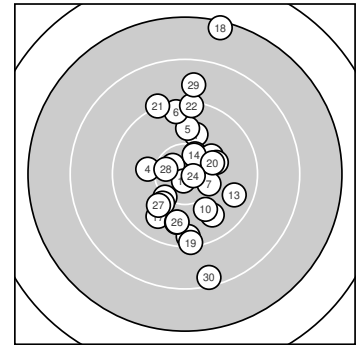

**Serie 1:**

10.0 ↑	9.8 ↘	10.4 *	10.1 ←	9.9 ↑
9.5 ↑	10.3 ↗	10.6 *	10.2 ↙	10.0 ↘

beste Teiler: 285.8 (8.), 428.8 (3.), 490.7 (7.)  
 Trefferlage: 0.32 mm rechts, 1.39 mm hoch  
 Streuwert: 5.48, horizontal: 3.97, vertikal: 6.65

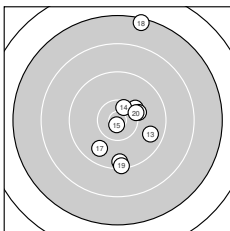

**Serie 2:**

10.2 ↗	10.2 →	9.7 ↘	10.5 *	10.8 *
9.5 ↓	9.8 ↙	7.4 ↑	9.3 ↓	10.2 →

beste Teiler: 132.9 (15.), 400.3 (14.), 565.0 (20.)  
 Trefferlage: 3.02 mm rechts, 0.11 mm hoch  
 Streuwert: 8.66, horizontal: 4.21, vertikal: 11.51

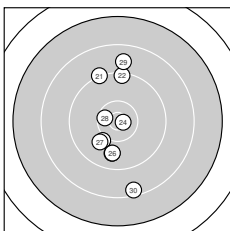

**Serie 3:**

9.2 ↘	9.3 ↑	9.8 ↓	10.8 *	10.1 ↙
9.8 ↓	10.0 ↙	10.5 *	8.8 ↑	8.4 ↓

beste Teiler: 159.8 (24.), 373.7 (28.), 694.4 (25.)  
 Trefferlage: 1.21 mm links, 0.57 mm tief  
 Streuwert: 8.61, horizontal: 3.34, vertikal: 11.70



**Ergebnis: 286.4 (272)**  
**Serien: 94.0 95.9 96.5**  
**Zähler: 11 12 5 2 0 0 0 0 0 0**  
**Innenzehner: 6**  
**Weiteste: 3098 (17.), 2424 (1.), 2023 (27.)**  
**beste Teiler: 272.0 (21.), 290.8 (11.), 333.0 (15.)**  
**Trefferlage: 0.36 mm rechts, 2.35 mm tief**  
**Streuwert: 9.20, horizontal: 9.71, vertikal: 8.65**

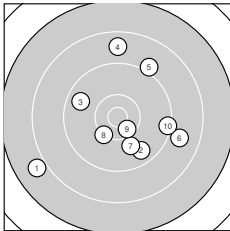
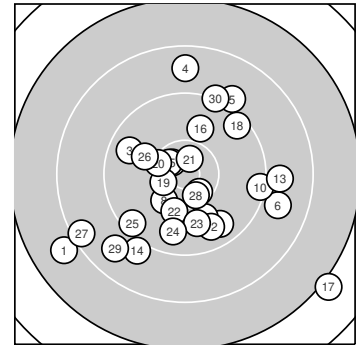

**Serie 1:**  
 7.9 ↙                      9.7 ↘                      9.7 ↖  
 8.9 ↘                      10.0 ↘                      10.2 ↗  
**beste Teiler: 385.5 (9.), 568.7 (8.), 800.0 (7.)**  
**Trefferlage: 1.48 mm rechts, 0.87 mm tief**  
**Streuwert: 10.21, horizontal: 10.69, vertikal: 9.70**

8.7 ↑                      9.1 ↗  
 10.5 \*                      9.3 →

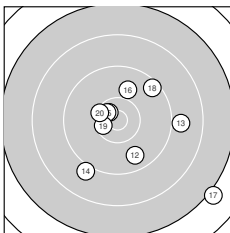

**Serie 2:**  
 10.6 \*                      9.7 ↘                      8.9 →  
 9.9 ↗                      7.1 ↘                      9.4 ↗  
**beste Teiler: 290.8 (11.), 333.0 (15.), 390.1 (19.)**  
**Trefferlage: 3.52 mm rechts, 2.13 mm tief**  
**Streuwert: 9.59, horizontal: 10.25, vertikal: 8.88**

9.0 ↘                      10.5 \*                      10.5 \*  
 10.5 \*                      10.3 ↖

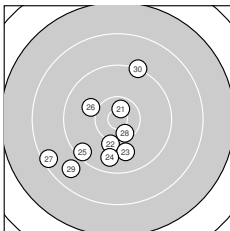

**Serie 3:**  
 10.6 \*                      10.1 ↓                      9.9 ↓  
 10.0 ↖                      8.4 ↙                      10.4 \*  
**beste Teiler: 272.0 (21.), 402.9 (28.), 653.5 (22.)**  
**Trefferlage: 3.91 mm links, 4.04 mm tief**  
**Streuwert: 7.55, horizontal: 7.18, vertikal: 7.90**

9.7 ↓                      9.4 ↙  
 8.8 ↙                      9.2 ↗



Ergebnis: **283.2** (270)  
 Serien: 97.8 94.7 90.7  
 Zähler: 10 11 8 1 0 0 0 0 0 0  
 Innenzehner: 6  
 Weitester: 2929 (3.), 2362 (24.), 2037 (23.)  
 beste Teiler: 126.4 (12.), 225.2 (5.), 245.9 (9.)  
 Trefferlage: 2.46 mm links, 5.22 mm tief  
 Streuwert: 9.11, horizontal: 7.73, vertikal: 10.32

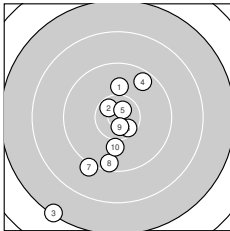
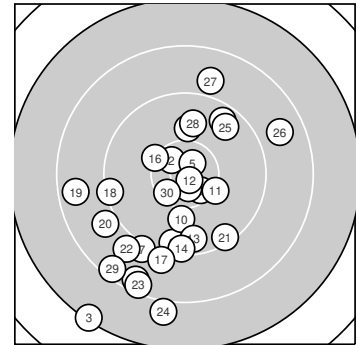

**Serie 1:**

10.0 ↑	10.5 *	7.3 ↘	9.6 ↗	10.7 *
10.5 *	9.1 ↘	9.5 ↓	10.6 *	10.0 ↓

beste Teiler: 225.2 (5.), 245.9 (9.), 328.8 (2.)  
 Trefferlage: 1.72 mm links, 4.03 mm tief  
 Streuwert: 8.49, horizontal: 6.23, vertikal: 10.27

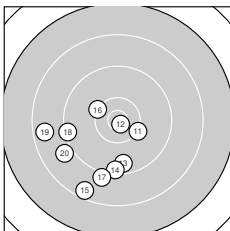

**Serie 2:**

10.2 ↘	10.8 *	9.6 ↓	9.4 ↓	8.5 ↘
10.2 ↖	9.1 ↓	9.3 ←	8.6 ←	9.0 ↖

beste Teiler: 126.4 (12.), 577.2 (16.), 589.7 (11.)  
 Trefferlage: 5.53 mm links, 7.14 mm tief  
 Streuwert: 7.17, horizontal: 7.61, vertikal: 6.71

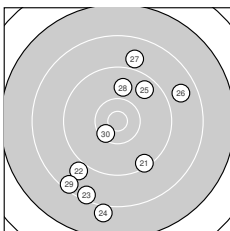

**Serie 3:**

9.4 ↘	8.9 ↘	8.4 ↘	8.0 ↓	9.6 ↗
8.8 ↗	8.9 ↑	9.9 ↑	8.4 ↘	10.4 *

beste Teiler: 435.6 (30.), 871.8 (28.), 1054.7 (25.)  
 Trefferlage: 0.13 mm links, 4.50 mm tief  
 Streuwert: 11.51, horizontal: 8.87, vertikal: 13.65





Ergebnis: **283.1** (269)  
 Serien: 92.7 92.3 98.1  
 Zähler: 13 9 3 4 1 0 0 0 0 0  
 Innenzehner: 6  
 Weitesten: 3383 (4.), 2738 (2.), 2675 (14.)  
 beste Teiler: 209.0 (24.), 209.1 (17.), 380.0 (30.)  
 Trefferlage: 0.35 mm links, 2.92 mm tief  
 Streuwert: 10.43, horizontal: 5.55, vertikal: 13.67

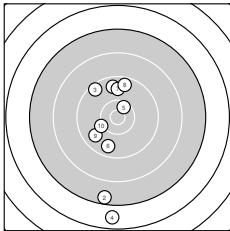
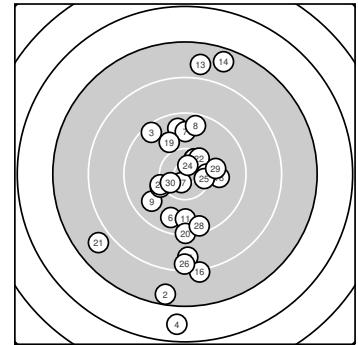

**Serie 1:**

9.6 ↑	7.5 ↓	9.4 ↘	6.7 ↓	10.5 *
9.7 ↓	9.8 ↑	9.6 ↑	9.7 ↙	10.2 ↙

beste Teiler: 397.3 (5.), 626.7 (10.), 957.0 (7.)  
 Trefferlage: 2.71 mm links, 3.60 mm tief  
 Streuwert: 11.59, horizontal: 3.58, vertikal: 15.99

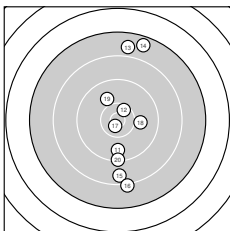

**Serie 2:**

9.7 ↓	10.4 *	7.8 ↑	7.6 ↑	8.6 ↓
8.2 ↓	10.7 *	10.0 →	10.0 ↘	9.3 ↓

beste Teiler: 209.1 (17.), 401.9 (12.), 775.4 (18.)  
 Trefferlage: 2.17 mm rechts, 0.61 mm tief  
 Streuwert: 11.92, horizontal: 3.78, vertikal: 16.42

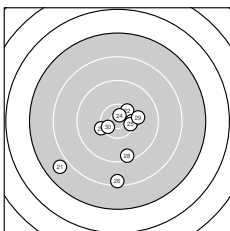

**Serie 3:**

7.8 ↙	10.3 ↗	10.3 →	10.7 *	10.4 *
8.4 ↓	10.2 ↙	9.4 ↓	10.1 →	10.5 *

beste Teiler: 209.0 (24.), 380.0 (30.), 446.3 (25.)  
 Trefferlage: 0.52 mm links, 4.57 mm tief  
 Streuwert: 7.93, horizontal: 7.67, vertikal: 8.18



Ergebnis: **287.7** (272)  
 Serien: 95.8 93.8 98.1  
 Zähler: 10 13 6 1 0 0 0 0 0 0  
 Innenzehner: 6  
 Weitest: 2679 (8.), 2125 (22.), 1870 (9.)  
 beste Teiler: 222.0 (7.), 305.3 (20.), 350.3 (2.)  
 Trefferlage: 0.81 mm links, 0.80 mm hoch  
 Streuwert: 8.91, horizontal: 5.90, vertikal: 11.14

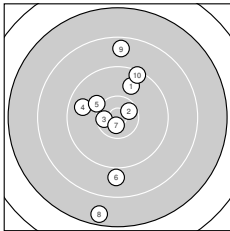
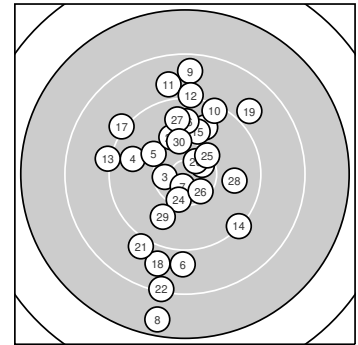

**Serie 1:**  
 9.8 ↗ 10.5 \* 10.5 \* 9.7 ← 10.1 ↖  
 8.9 ↓ 10.7 \* 7.6 ↓ 8.6 ↑ 9.4 ↗  
 beste Teiler: 222.0 (7.), 350.3 (2.), 370.5 (3.)  
 Trefferlage: 1.16 mm links, 0.13 mm hoch  
 Streuwert: 9.84, horizontal: 4.71, vertikal: 13.09

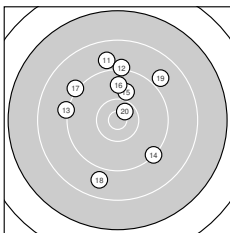

**Serie 2:**  
 8.9 ↑ 9.2 ↑ 9.2 ← 9.3 ↘ 9.9 ↑  
 9.8 ↑ 9.2 ↖ 8.8 ↓ 8.9 ↗ 10.6 \*  
 beste Teiler: 305.3 (20.), 804.5 (15.), 959.3 (16.)  
 Trefferlage: 0.64 mm links, 4.74 mm hoch  
 Streuwert: 9.32, horizontal: 8.16, vertikal: 10.35

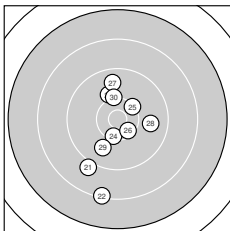

**Serie 3:**  
 9.0 ↘ 8.3 ↓ 10.1 ↑ 10.4 \* 10.3 ↗  
 10.4 \* 9.7 ↑ 9.8 → 9.9 ↓ 10.2 ↑  
 beste Teiler: 419.7 (26.), 475.6 (24.), 526.6 (25.)  
 Trefferlage: 0.64 mm links, 2.45 mm tief  
 Streuwert: 7.58, horizontal: 4.82, vertikal: 9.58



# LP Auflage 30 – Wertung –Senioren II männl.

StandNr: 84

Wunderlich, Leo #1092

StartNr: 1040

7. Mai 2022 13:21

5000 KKS SV Geseke e.V.

Ergebnis: **294.3** (280)  
 Serien: 99.0 98.5 96.8  
 Zähler: 14 12 4 0 0 0 0 0 0 0  
 Innenzehner: 7  
 Weitester: 1803 (20.), 1769 (18.), 1707 (29.)  
 beste Teiler: 158.5 (23.), 197.0 (16.), 247.4 (2.)  
 Trefferlage: 2.51 mm rechts, 1.60 mm hoch  
 Streuwert: 7.17, horizontal: 5.73, vertikal: 8.36

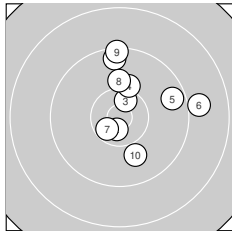
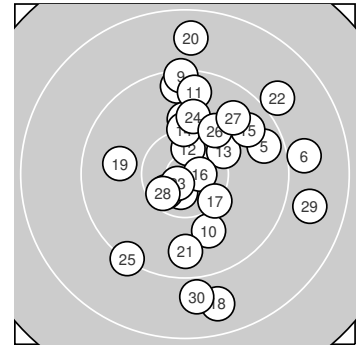

**Serie 1:**

9.5 ↑	10.6 *	10.5 *	10.1 ↑	9.6 →
9.0 →	10.5 *	10.0 ↑	9.3 ↑	9.9 ↓

beste Teiler: 247.4 (2.), 340.2 (7.), 353.0 (3.)  
 Trefferlage: 2.77 mm rechts, 3.53 mm hoch  
 Streuwert: 6.12, horizontal: 5.81, vertikal: 6.41

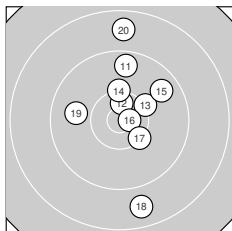

**Serie 2:**

9.6 ↑	10.5 *	10.2 ↗	10.2 ↑	9.7 ↗
10.7 *	10.3 ↘	8.7 ↓	9.9 ←	8.7 ↑

beste Teiler: 197.0 (16.), 339.4 (12.), 531.8 (17.)  
 Trefferlage: 1.73 mm rechts, 2.77 mm hoch  
 Streuwert: 7.24, horizontal: 4.48, vertikal: 9.22

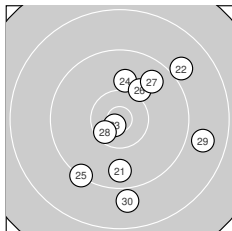

**Serie 3:**

9.7 ↓	9.0 ↗	10.8 *	10.0 ↑	9.3 ↘
10.1 ↗	9.7 ↗	10.5 *	8.8 →	8.9 ↓

beste Teiler: 158.5 (23.), 388.3 (28.), 701.5 (26.)  
 Trefferlage: 3.03 mm rechts, 1.48 mm tief  
 Streuwert: 8.19, horizontal: 7.15, vertikal: 9.11



# LP Auflage 30 – Wertung –Senioren II männl.

StandNr: 91

Lange, Rainer #1132

StartNr: 1041

7. Mai 2022 13:11

5000 SpSch Soest Nord-West

Ergebnis: **296.7** (283)  
 Serien: 99.6 97.8 99.3  
 Zähler: 16 11 3 0 0 0 0 0 0 0  
 Innenzehner: 6  
 Weitester: 1935 (15.), 1734 (9.), 1632 (25.)  
 beste Teiler: 62.9 (21.), 213.4 (3.), 218.4 (26.)  
 Trefferlage: 0.12 mm rechts, 0.54 mm hoch  
 Streuwert: 6.96, horizontal: 4.65, vertikal: 8.67

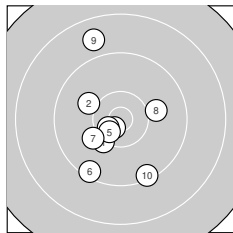
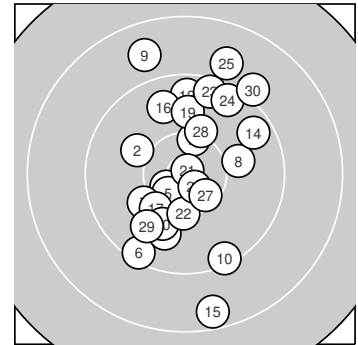

**Serie 1:**  
 10.2 ↙ 10.0 ↘ 10.7 \* 10.6 \* 10.5 \*  
 9.4 ↙ 10.1 ↗ 10.0 → 8.8 ↕ 9.3 ↘  
 beste Teiler: 213.4 (3.), 309.2 (4.), 347.0 (5.)  
 Trefferlage: 2.10 mm links, 1.55 mm tief  
 Streuwert: 6.56, horizontal: 4.87, vertikal: 7.90

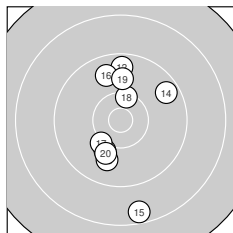

**Serie 2:**  
 10.1 ↙ 9.6 ↑ 9.9 ↙ 9.6 ↗ 8.5 ↓  
 9.7 ↕ 10.2 ↙ 10.3 ↑ 9.9 ↑ 10.0 ↙  
 beste Teiler: 492.5 (18.), 619.8 (17.), 705.3 (11.)  
 Trefferlage: 0.10 mm links, 0.57 mm tief  
 Streuwert: 7.55, horizontal: 4.20, vertikal: 9.82

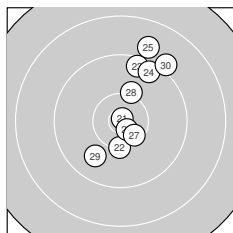

**Serie 3:**  
 10.9 \* 10.3 ↓ 9.5 ↑ 9.5 ↗ 8.9 ↗  
 10.7 \* 10.4 \* 10.2 ↑ 9.8 ↙ 9.1 ↗  
 beste Teiler: 62.9 (21.), 218.4 (26.), 405.2 (27.)  
 Trefferlage: 2.57 mm rechts, 3.77 mm hoch  
 Streuwert: 6.38, horizontal: 4.00, vertikal: 8.09



**Ergebnis: 294.1 (282)**  
**Serien: 95.2 101.8 97.1**  
**Zähler: 16 11 2 1 0 0 0 0 0 0**  
**Innenzehner: 7**  
**Weiteste: 2745 (2.), 2179 (29.), 1917 (8.)**  
**beste Teiler: 265.4 (5.), 265.9 (14.), 284.6 (16.)**  
**Trefferlage: 3.05 mm rechts, 1.22 mm tief**  
**Streuwert: 7.48, horizontal: 7.16, vertikal: 7.79**

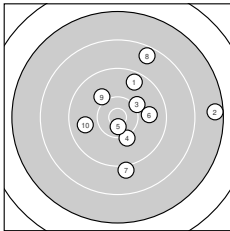
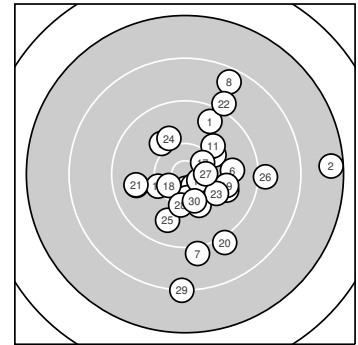

**Serie 1:**

9.6 ↗	7.5 →	10.1 ↘	10.1 ↓	10.6 *
9.8 →	9.1 ↓	8.6 ↗	10.0 ↘	9.8 ←

**beste Teiler: 265.4 (5.), 643.1 (4.), 652.3 (3.)**  
**Trefferlage: 4.63 mm rechts, 1.32 mm hoch**  
**Streuwert: 9.27, horizontal: 9.72, vertikal: 8.79**

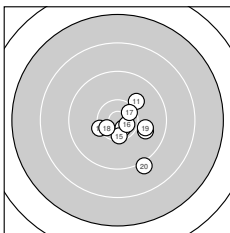

**Serie 2:**

10.0 ↗	10.3 ←	9.9 →	10.6 *	10.4 *
10.6 *	10.5 *	10.5 *	9.9 →	9.1 ↓

**beste Teiler: 265.9 (14.), 284.6 (16.), 370.6 (18.)**  
**Trefferlage: 2.81 mm rechts, 2.26 mm tief**  
**Streuwert: 4.57, horizontal: 4.49, vertikal: 4.65**

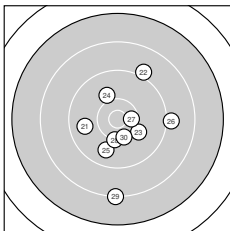

**Serie 3:**

9.8 ←	9.1 ↗	10.1 ↘	10.0 ↘	9.8 ↓
9.1 →	10.5 *	10.2 ↓	8.2 ↓	10.3 ↓

**beste Teiler: 388.0 (27.), 532.0 (30.), 584.6 (28.)**  
**Trefferlage: 1.71 mm rechts, 2.73 mm tief**  
**Streuwert: 8.10, horizontal: 6.75, vertikal: 9.25**



# LP Auflage 30 – Wertung –Senioren II männl.

StandNr: 74

**Niggeloh, Volker** #780

**StartNr: 1054**

7. Mai 2022 13:02

WF KKS SV Gevelsberg e.V.

**Ergebnis: 294.3 (279)**  
**Serien: 97.1 98.4 98.8**  
**Zähler: 11 17 2 0 0 0 0 0 0 0**  
**Innenzehner: 5**  
**Weiteste: 1832 (3.), 1771 (5.), 1574 (30.)**  
**beste Teiler: 130.3 (27.), 180.7 (15.), 213.6 (4.)**  
**Trefferlage: 1.47 mm links, 0.94 mm tief**  
**Streuwert: 7.15, horizontal: 3.84, vertikal: 9.35**

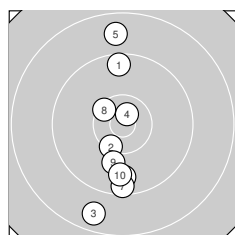
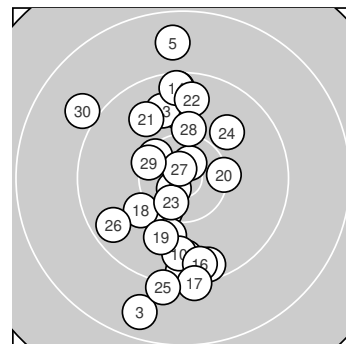

**Serie 1:**  
 9.5 ↑                      10.3 ↙                      8.7 ↓                      10.7 \*                      8.7 ↑  
 9.7 ↓                      9.4 ↓                      10.4 \*                      10.0 ↓                      9.7 ↓  
**beste Teiler: 213.6 (4.), 459.1 (8.), 491.1 (2.)**  
**Trefferlage: 1.47 mm links, 2.72 mm tief**  
**Streuwert: 7.98, horizontal: 1.97, vertikal: 11.12**

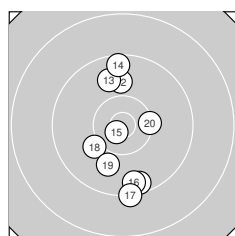

**Serie 2:**  
 9.5 ↓                      9.9 ↑                      9.8 ↗                      9.5 ↑                      10.7 \*  
 9.5 ↓                      9.2 ↓                      10.1 ↙                      9.9 ↓                      10.3 →  
**beste Teiler: 180.7 (15.), 534.7 (20.), 692.0 (18.)**  
**Trefferlage: 0.11 mm links, 1.98 mm tief**  
**Streuwert: 6.91, horizontal: 3.23, vertikal: 9.22**

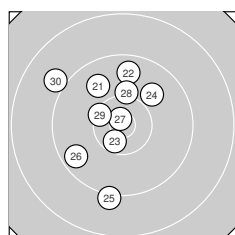

**Serie 3:**  
 9.8 ↘                      9.7 ↑                      10.5 \*                      9.9 ↗                      9.1 ↓  
 9.6 ↙                      10.8 \*                      10.1 ↑                      10.3 ↖                      9.0 ↘  
**beste Teiler: 130.3 (27.), 351.0 (23.), 490.9 (29.)**  
**Trefferlage: 2.83 mm links, 1.88 mm hoch**  
**Streuwert: 6.66, horizontal: 5.38, vertikal: 7.72**



Ergebnis: **283.1** (269)  
 Serien: 97.2 92.7 93.2  
 Zähler: 10 11 7 2 0 0 0 0 0 0  
 Innenzehner: 2  
 Weitesten: 2949 (24.), 2479 (14.), 1892 (26.)  
 beste Teiler: 363.6 (25.), 370.2 (30.), 569.1 (19.)  
 Trefferlage: 1.08 mm links, 3.07 mm hoch  
 Streuwert: 9.48, horizontal: 9.75, vertikal: 9.19

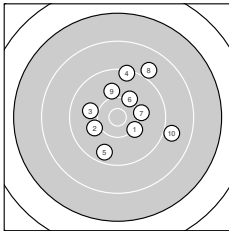
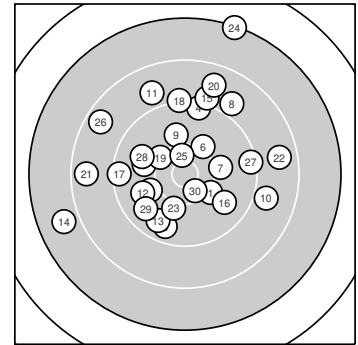

**Serie 1:**

10.2 ↘	10.0 ←	10.0 ←	9.3 ↑	9.6 ↓
10.2 ↗	10.1 →	8.9 ↗	10.0 ↑	8.9 →

beste Teiler: 602.1 (1.), 626.8 (6.), 692.1 (7.)  
 Trefferlage: 2.23 mm rechts, 2.07 mm hoch  
 Streuwert: 7.48, horizontal: 7.30, vertikal: 7.65

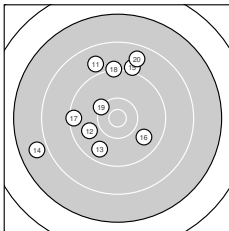

**Serie 2:**

8.9 ↖	9.8 ←	9.7 ↓	7.9 ←	9.1 ↑
9.8 ↘	9.4 ←	9.2 ↑	10.2 ↘	8.7 ↑

beste Teiler: 569.1 (19.), 881.4 (12.), 926.0 (16.)  
 Trefferlage: 4.36 mm links, 3.73 mm hoch  
 Streuwert: 9.91, horizontal: 9.18, vertikal: 10.59

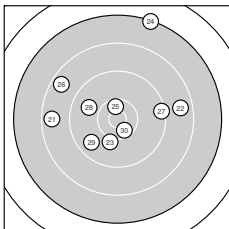

**Serie 3:**

8.6 ←	8.7 →	10.1 ↓	7.3 ↑	10.5 *
8.6 ↘	9.4 →	9.8 ↘	9.7 ↓	10.5 *

beste Teiler: 363.6 (25.), 370.2 (30.), 684.6 (23.)  
 Trefferlage: 1.13 mm links, 3.41 mm hoch  
 Streuwert: 11.06, horizontal: 12.03, vertikal: 9.99



Ergebnis: **275.2** (262)  
 Serien: 90.7 91.3 93.2  
 Zähler: 5 15 7 3 0 0 0 0 0 0  
 Innenzehner: 1  
 Weitesten: 2907 (7.), 2712 (12.), 2568 (29.)  
 beste Teiler: 200.9 (27.), 499.9 (19.), 565.7 (25.)  
 Trefferlage: 5.04 mm rechts, 2.51 mm tief  
 Streuwert: 10.41, horizontal: 8.47, vertikal: 12.04

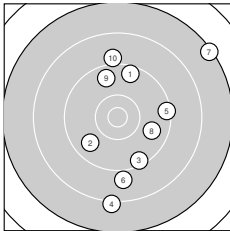
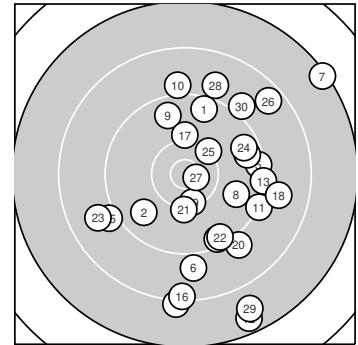

**Serie 1:**

9.5 ↑	9.7 ↙	9.4 ↓	8.1 ↓	9.4 →
8.9 ↓	7.3 ↗	9.8 ↘	9.6 ↑	9.0 ↑

beste Teiler: 948.0 (8.), 965.8 (2.), 1050.9 (9.)  
 Trefferlage: 4.26 mm rechts, 0.46 mm tief  
 Streuwert: 11.58, horizontal: 8.97, vertikal: 13.70

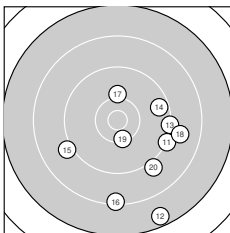

**Serie 2:**

9.2 ↘	7.6 ↓	9.3 →	9.5 →	9.1 ↙
8.3 ↓	10.1 ↑	8.9 →	10.3 ↓	9.0 ↓

beste Teiler: 499.9 (19.), 673.0 (17.), 1123.4 (14.)  
 Trefferlage: 6.11 mm rechts, 7.08 mm tief  
 Streuwert: 9.47, horizontal: 8.98, vertikal: 9.93

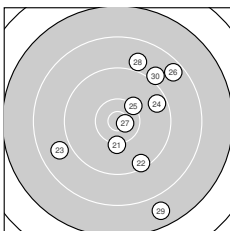

**Serie 3:**

10.2 ↓	9.4 ↓	8.9 ↙	9.6 →	10.2 ↗
8.6 ↗	10.7 *	8.9 ↑	7.7 ↓	9.0 ↗

beste Teiler: 200.9 (27.), 565.7 (25.), 610.2 (21.)  
 Trefferlage: 4.75 mm rechts, 0.00 mm  
 Streuwert: 10.34, horizontal: 8.25, vertikal: 12.08





Ergebnis: **276.2** (261)  
 Serien: 92.9 92.0 91.3  
 Zähler: 7 12 8 1 2 0 0 0 0 0  
 Innenzehner: 3  
 Weitester: 3903 (27.), 3598 (4.), 2514 (13.)  
 beste Teiler: 420.3 (28.), 448.4 (24.), 469.3 (1.)  
 Trefferlage: 1.63 mm links, 1.34 mm tief  
 Streuwert: 11.59, horizontal: 9.11, vertikal: 13.62

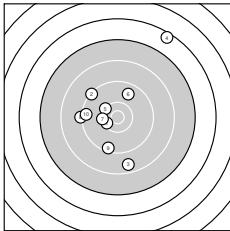
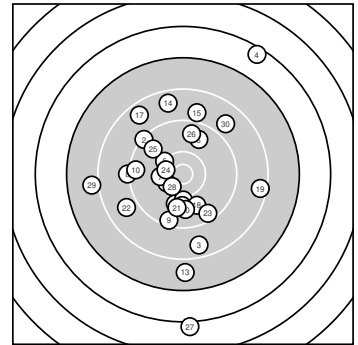

**Serie 1:**

10.4 *	9.3 ↘	8.6 ↓	6.5 ↗	10.2 ↖
9.7 ↗	10.2 ←	9.2 ←	9.4 ↓	9.4 ←

beste Teiler: 469.3 (1.), 572.8 (5.), 585.2 (7.)  
 Trefferlage: 2.73 mm links, 2.00 mm hoch  
 Streuwert: 11.52, horizontal: 9.71, vertikal: 13.08

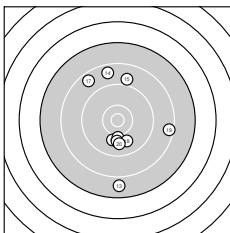

**Serie 2:**

10.0 ↓	10.1 ↓	7.8 ↓	8.6 ↑	8.9 ↑
9.9 ↓	8.6 ↘	9.9 ↓	8.4 →	9.8 ↓

beste Teiler: 661.0 (12.), 781.9 (11.), 802.2 (16.)  
 Trefferlage: 1.10 mm rechts, 1.90 mm tief  
 Streuwert: 11.23, horizontal: 7.80, vertikal: 13.84

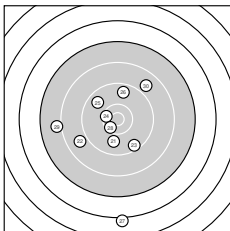

**Serie 3:**

9.9 ↓	8.9 ↙	9.5 ↘	10.4 *	9.7 ↖
9.6 ↑	6.1 ↓	10.4 *	8.0 ←	8.8 ↗

beste Teiler: 420.3 (28.), 448.4 (24.), 866.6 (21.)  
 Trefferlage: 3.27 mm links, 4.13 mm tief  
 Streuwert: 12.53, horizontal: 9.99, vertikal: 14.63



Ergebnis: **291.9** (279)  
 Serien: 93.5 96.7 101.7  
 Zähler: 13 14 2 1 0 0 0 0 0 0  
 Innenzehner: 4  
 Weitester: 2650 (4.), 1767 (1.), 1696 (16.)  
 beste Teiler: 103.1 (28.), 247.9 (18.), 386.1 (26.)  
 Trefferlage: 1.97 mm rechts, 2.62 mm tief  
 Streuwert: 7.55, horizontal: 4.79, vertikal: 9.55

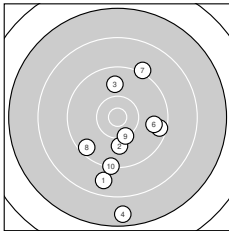
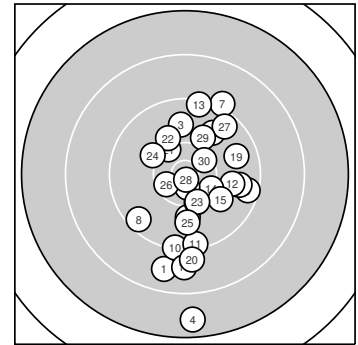

**Serie 1:**

8.7 ↓	10.0 ↓	9.8 ↑	7.6 ↓	9.5 →
9.7 →	9.1 ↗	9.5 ↘	10.3 ↓	9.3 ↓

beste Teiler: 554.0 (9.), 785.6 (2.), 904.0 (3.)  
 Trefferlage: 1.74 mm rechts, 6.13 mm tief  
 Streuwert: 9.29, horizontal: 6.16, vertikal: 11.61

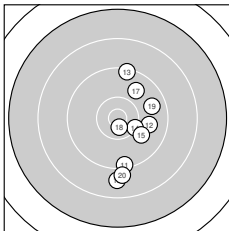

**Serie 2:**

9.3 ↓	9.9 →	9.3 ↑	10.3 ↘	10.0 ↘
8.8 ↓	9.8 ↗	10.6 *	9.7 →	9.0 ↓

beste Teiler: 247.9 (18.), 543.2 (14.), 791.5 (15.)  
 Trefferlage: 4.02 mm rechts, 3.30 mm tief  
 Streuwert: 7.26, horizontal: 3.36, vertikal: 9.70

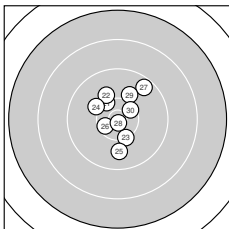

**Serie 3:**

10.3 ↖	10.0 ↖	10.3 ↓	10.1 ↖	9.8 ↓
10.5 *	9.5 ↗	10.8 *	10.0 ↗	10.4 *

beste Teiler: 103.1 (28.), 386.1 (26.), 433.2 (30.)  
 Trefferlage: 0.15 mm rechts, 1.56 mm hoch  
 Streuwert: 4.88, horizontal: 4.01, vertikal: 5.61



Ergebnis: **294.5** (280)  
 Serien: 99.7 95.9 98.9  
 Zähler: 14 12 4 0 0 0 0 0 0 0  
 Innenzehner: 8  
 Weitester: 2083 (11.), 2016 (14.), 1814 (4.)  
 beste Teiler: 146.1 (15.), 222.9 (9.), 325.1 (20.)  
 Trefferlage: 1.59 mm links, 3.53 mm hoch  
 Streuwert: 6.93, horizontal: 4.57, vertikal: 8.67

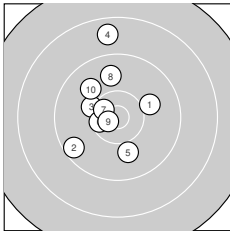
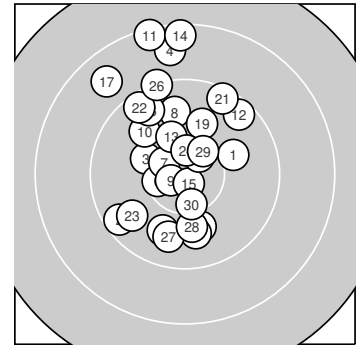

**Serie 1:**

10.0 ↗	9.5 ↖	10.2 ↖	8.7 ↑	10.0 ↓
10.4 *	10.5 *	9.8 ↑	10.7 *	9.9 ↖

beste Teiler: 222.9 (9.), 343.3 (7.), 409.4 (6.)  
 Trefferlage: 2.43 mm links, 2.38 mm hoch  
 Streuwert: 6.21, horizontal: 4.57, vertikal: 7.51

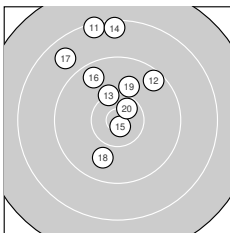

**Serie 2:**

8.3 ↑	9.5 ↗	10.2 ↖	8.4 ↑	10.8 *
9.6 ↖	8.7 ↖	9.9 ↓	10.0 ↗	10.5 *

beste Teiler: 146.1 (15.), 325.1 (20.), 576.3 (13.)  
 Trefferlage: 1.46 mm links, 7.74 mm hoch  
 Streuwert: 7.31, horizontal: 5.25, vertikal: 8.90

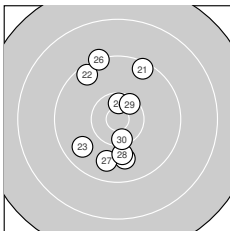

**Serie 3:**

9.4 ↗	9.5 ↖	9.7 ↖	10.5 *	9.9 ↓
9.3 ↖	9.8 ↓	10.0 ↓	10.4 *	10.4 *

beste Teiler: 344.7 (24.), 424.3 (29.), 446.2 (30.)  
 Trefferlage: 0.89 mm links, 0.47 mm hoch  
 Streuwert: 6.79, horizontal: 4.19, vertikal: 8.65



Ergebnis: **294.4** (280)  
 Serien: 99.6 95.1 99.7  
 Zähler: 13 15 1 1 0 0 0 0 0 0  
 Innenzehner: 6  
 Weitester: 2609 (17.), 2078 (11.), 1507 (6.)  
 beste Teiler: 170.2 (15.), 345.6 (24.), 368.5 (3.)  
 Trefferlage: 0.49 mm rechts, 0.37 mm tief  
 Streuwert: 7.55, horizontal: 4.35, vertikal: 9.74

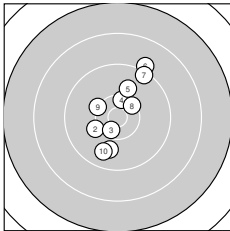
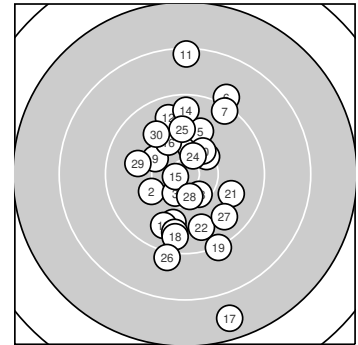

**Serie 1:**

9.9 ↓	10.1 ↖	10.5 *	10.4 *	10.0 ↑
9.1 ↗	9.3 ↗	10.3 ↗	10.2 ↘	9.8 ↓

beste Teiler: 368.5 (3.), 464.0 (4.), 481.9 (8.)  
 Trefferlage: 0.31 mm rechts, 1.83 mm hoch  
 Streuwert: 6.33, horizontal: 4.72, vertikal: 7.62

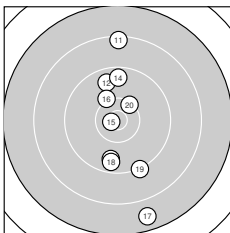

**Serie 2:**

8.4 ↑	9.7 ↑	9.7 ↓	9.6 ↑	10.7 *
10.2 ↘	7.7 ↓	9.6 ↓	9.2 ↘	10.3 ↗

beste Teiler: 170.2 (15.), 506.2 (20.), 623.9 (16.)  
 Trefferlage: 0.61 mm rechts, 0.77 mm tief  
 Streuwert: 10.04, horizontal: 3.72, vertikal: 13.70

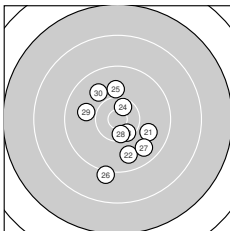

**Serie 3:**

9.9 ↘	9.8 ↓	10.4 *	10.5 *	10.0 ↑
9.1 ↓	9.7 ↘	10.5 *	9.9 ↖	9.9 ↘

beste Teiler: 345.6 (24.), 394.8 (28.), 425.8 (23.)  
 Trefferlage: 0.56 mm rechts, 2.19 mm tief  
 Streuwert: 6.16, horizontal: 5.00, vertikal: 7.13



Ergebnis: **285.8** (272)  
 Serien: 89.2 97.3 99.3  
 Zähler: 13 10 5 0 2 0 0 0 0 0  
 Innenzehner: 8  
 Weitestе: 3920 (9.), 3910 (6.), 2126 (14.)  
 beste Teiler: 83.6 (11.), 160.9 (21.), 204.3 (2.)  
 Trefferlage: 2.29 mm rechts, 0.75 mm hoch  
 Streuwert: 10.54, horizontal: 7.02, vertikal: 13.15

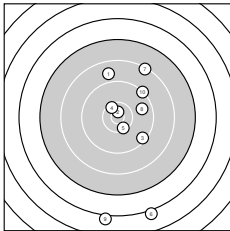
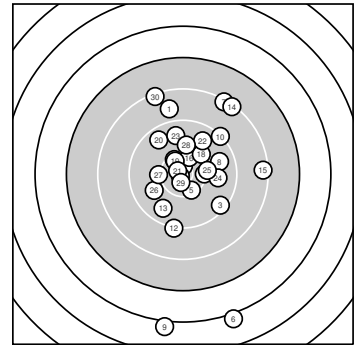

**Serie 1:**  
 8.8 ↑                      10.7 \*                      9.4 ↘                      10.4 \*                      10.4 \*  
 6.1 ↓                      8.3 ↗                      9.7 →                      6.1 ↓                      9.3 ↗  
 beste Teiler: 204.3 (2.), 433.2 (4.), 462.0 (5.)  
 Trefferlage: 4.37 mm rechts, 3.41 mm tief  
 Streuwert: 14.87, horizontal: 6.65, vertikal: 19.94

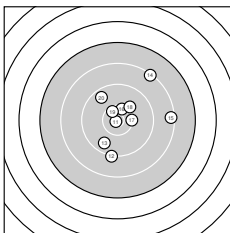

**Serie 2:**  
 10.8 \*                      9.2 ↓                      9.7 ↙                      8.3 ↗                      8.4 →  
 10.4 \*                      10.3 →                      10.1 ↗                      10.5 \*                      9.6 ↘  
 beste Teiler: 83.6 (11.), 387.9 (19.), 456.6 (16.)  
 Trefferlage: 2.84 mm rechts, 1.66 mm hoch  
 Streuwert: 8.46, horizontal: 8.31, vertikal: 8.61

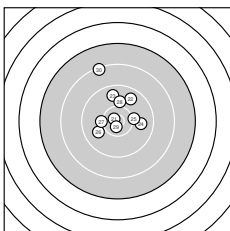

**Serie 3:**  
 10.8 \*                      9.7 ↗                      9.7 ↑                      9.8 →                      10.2 →  
 9.9 ↙                      10.2 ←                      10.0 ↑                      10.7 \*                      8.3 ↘  
 beste Teiler: 160.9 (21.), 219.4 (29.), 623.1 (27.)  
 Trefferlage: 0.33 mm links, 4.00 mm hoch  
 Streuwert: 6.55, horizontal: 5.70, vertikal: 7.31



Ergebnis: **285.5** (271)  
 Serien: 95.6 93.8 96.1  
 Zähler: 8 16 5 1 0 0 0 0 0 0  
 Innenzehner: 5  
 Weitesten: 2501 (7.), 2365 (24.), 2277 (1.)  
 beste Teiler: 57.0 (25.), 219.5 (16.), 339.9 (15.)  
 Trefferlage: 4.79 mm links, 1.34 mm hoch  
 Streuwert: 8.78, horizontal: 7.55, vertikal: 9.86

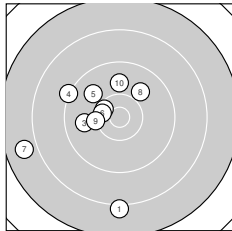
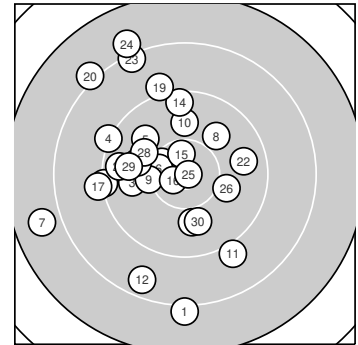

**Serie 1:**

8.1 ↓	10.4 *	9.8 ←	9.2 ↖	9.9 ↗
10.4 *	7.8 ←	9.9 ↗	10.2 ←	9.9 ↑

beste Teiler: 433.9 (2.), 443.1 (6.), 604.4 (9.)  
 Trefferlage: 6.07 mm links, 0.33 mm tief  
 Streuwert: 8.63, horizontal: 7.95, vertikal: 9.26

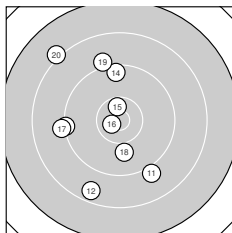

**Serie 2:**

9.0 ↘	8.6 ↙	9.3 ←	9.5 ↑	10.5 *
10.7 *	9.1 ←	9.9 ↓	9.1 ↑	8.1 ↘

beste Teiler: 219.5 (16.), 339.9 (15.), 805.3 (18.)  
 Trefferlage: 4.92 mm links, 0.27 mm hoch  
 Streuwert: 9.74, horizontal: 7.68, vertikal: 11.44

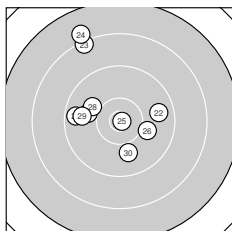

**Serie 3:**

9.6 ←	9.7 →	8.3 ↗	8.0 ↗	10.9 *
10.0 →	9.9 ←	10.0 ↖	9.8 ←	9.9 ↓

beste Teiler: 57.0 (25.), 727.3 (26.), 765.4 (28.)  
 Trefferlage: 3.38 mm links, 4.08 mm hoch  
 Streuwert: 8.41, horizontal: 7.57, vertikal: 9.18



Ergebnis: **289.0** (273)  
 Serien: 99.5 93.3 96.2  
 Zähler: 12 14 1 1 2 0 0 0 0 0  
 Innenzehner: 5  
 Weitesten: 3593 (29.), 3364 (14.), 2662 (13.)  
 beste Teiler: 208.0 (2.), 225.7 (30.), 310.0 (7.)  
 Trefferlage: 0.40 mm links, 4.22 mm tief  
 Streuwert: 8.97, horizontal: 6.08, vertikal: 11.13

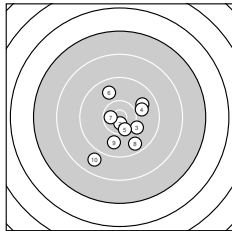
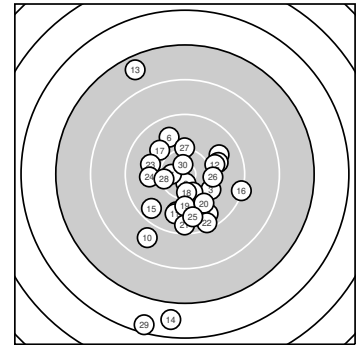

**Serie 1:**

9.8 ↗	10.7 *	10.1 ↘	9.9 →	10.4 *
9.8 ↘	10.6 *	9.6 ↘	9.8 ↓	8.8 ↙

beste Teiler: 208.0 (2.), 310.0 (7.), 454.0 (5.)  
 Trefferlage: 1.14 mm rechts, 2.65 mm tief  
 Streuwert: 6.29, horizontal: 5.55, vertikal: 6.95

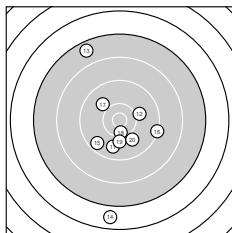

**Serie 2:**

9.8 ↓	10.0 →	7.6 ↘	6.7 ↓	9.6 ↙
9.3 →	9.9 ↘	10.4 *	10.0 ↓	10.0 ↘

beste Teiler: 420.6 (18.), 722.6 (12.), 736.0 (19.)  
 Trefferlage: 0.59 mm links, 4.07 mm tief  
 Streuwert: 11.35, horizontal: 7.25, vertikal: 14.32

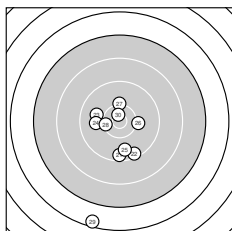

**Serie 3:**

9.5 ↓	9.4 ↘	9.9 ←	9.9 ←	9.7 ↓
10.1 →	10.2 ↑	10.3 ←	6.5 ↓	10.7 *

beste Teiler: 225.7 (30.), 495.5 (28.), 607.0 (27.)  
 Trefferlage: 1.77 mm links, 5.92 mm tief  
 Streuwert: 9.25, horizontal: 5.59, vertikal: 11.83



Ergebnis: **282.6** (270)  
 Serien: 90.7 93.6 98.3  
 Zähler: 7 17 5 1 0 0 0 0 0 0  
 Innenzehner: 3  
 Weitesten: 2889 (2.), 2266 (17.), 2022 (1.)  
 beste Teiler: 171.1 (23.), 311.7 (28.), 467.6 (16.)  
 Trefferlage: 0.19 mm rechts, 0.24 mm hoch  
 Streuwert: 9.74, horizontal: 6.63, vertikal: 12.08

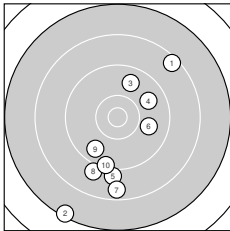
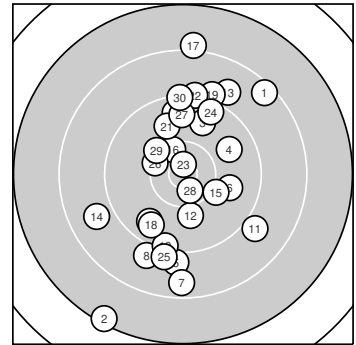

**Serie 1:**

8.4 ↗	7.3 ↘	9.7 ↑	9.8 ↗	9.0 ↓
9.9 ↘	8.6 ↓	9.0 ↘	9.7 ↘	9.3 ↓

beste Teiler: 855.0 (6.), 920.7 (4.), 965.3 (3.)  
 Trefferlage: 0.33 mm rechts, 6.97 mm tief  
 Streuwert: 10.87, horizontal: 8.35, vertikal: 12.91

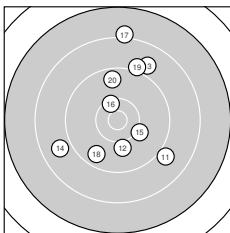

**Serie 2:**

9.0 ↘	10.0 ↓	8.9 ↑	8.8 ↖	10.1 ↘
10.4 *	8.1 ↑	9.6 ↘	9.1 ↑	9.6 ↑

beste Teiler: 467.6 (16.), 661.9 (15.), 738.8 (12.)  
 Trefferlage: 1.06 mm rechts, 2.96 mm hoch  
 Streuwert: 9.97, horizontal: 7.75, vertikal: 11.77

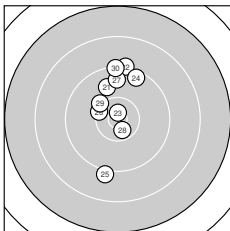

**Serie 3:**

9.8 ↑	9.2 ↑	10.7 *	9.5 ↑	9.1 ↓
10.3 ↖	9.6 ↑	10.6 *	10.2 ↘	9.3 ↑

beste Teiler: 171.1 (23.), 311.7 (28.), 527.1 (26.)  
 Trefferlage: 0.80 mm links, 4.75 mm hoch  
 Streuwert: 6.57, horizontal: 3.12, vertikal: 8.75





**Ergebnis: 280.2 (266)**  
**Serien: 92.7 90.9 96.6**  
**Zähler: 7 13 9 1 0 0 0 0 0 0**  
**Innenzehner: 3**  
**Weiteste: 3083 (11.), 1972 (12.), 1905 (2.)**  
**beste Teiler: 356.8 (6.), 369.8 (14.), 375.9 (25.)**  
**Trefferlage: 0.98 mm rechts, 1.59 mm tief**  
**Streuwert: 10.09, horizontal: 8.30, vertikal: 11.61**

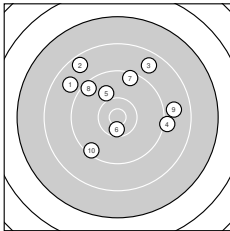
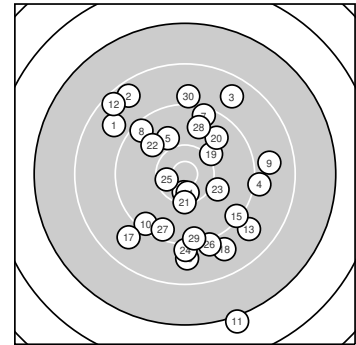

**Serie 1:**

8.8 ↘	8.6 ↘	8.7 ↗	9.1 →	10.0 ↖
10.5 *	9.4 ↗	9.4 ↘	8.8 →	9.4 ↙

**beste Teiler: 356.8 (6.), 785.4 (5.), 1212.6 (8.)**  
**Trefferlage: 0.07 mm links, 5.46 mm hoch**  
**Streuwert: 9.73, horizontal: 10.84, vertikal: 8.47**

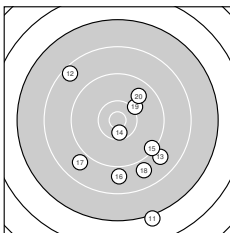

**Serie 2:**

7.1 ↓	8.5 ↘	8.9 ↘	10.5 *	9.3 ↘
8.9 ↓	8.9 ↙	8.9 ↓	10.1 ↗	9.8 ↗

**beste Teiler: 369.8 (14.), 651.0 (19.), 952.0 (20.)**  
**Trefferlage: 2.80 mm rechts, 7.06 mm tief**  
**Streuwert: 11.03, horizontal: 9.06, vertikal: 12.70**

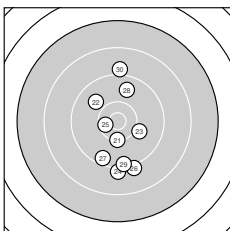

**Serie 3:**

10.3 ↓	9.9 ↘	10.1 ↘	9.1 ↓	10.5 *
9.1 ↓	9.5 ↙	9.7 ↗	9.4 ↓	9.0 ↑

**beste Teiler: 375.9 (25.), 554.0 (21.), 710.8 (23.)**  
**Trefferlage: 0.21 mm rechts, 3.16 mm tief**  
**Streuwert: 7.96, horizontal: 4.07, vertikal: 10.49**



Ergebnis: **270.1** (256)  
 Serien: 91.8 85.2 93.1  
 Zähler: 8 8 9 3 1 1 0 0 0 0  
 Innenzehner: 1  
 Weitesten: 4190 (13.), 3230 (18.), 2803 (26.)  
 beste Teiler: 460.0 (29.), 495.6 (8.), 516.2 (30.)  
 Trefferlage: 0.26 mm links, 1.76 mm tief  
 Streuwert: 12.90, horizontal: 11.96, vertikal: 13.78

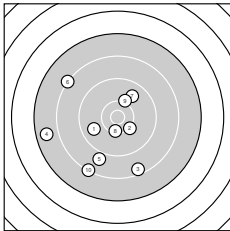
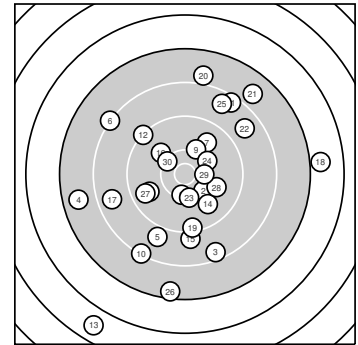

**Serie 1:**  
 9.8 ↙                      10.2 ↘                      8.5 ↓                      7.7 ←                      8.9 ↘  
 8.2 ↘                      9.8 ↗                      10.3 ↓                      10.1 ↗                      8.3 ↘  
 beste Teiler: 495.6 (8.), 586.3 (2.), 644.1 (9.)  
 Trefferlage: 4.97 mm links, 4.52 mm tief  
 Streuwert: 10.79, horizontal: 10.72, vertikal: 10.85

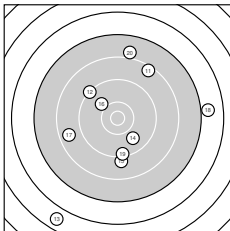

**Serie 2:**  
 8.4 ↗                      9.3 ↘                      5.7 ↘                      9.8 ↘                      9.0 ↓  
 10.0 ↘                      8.7 ←                      6.9 →                      9.4 ↓                      8.0 ↑  
 beste Teiler: 762.1 (16.), 895.2 (14.), 1280.2 (19.)  
 Trefferlage: 0.14 mm rechts, 1.93 mm tief  
 Streuwert: 16.32, horizontal: 15.31, vertikal: 17.28

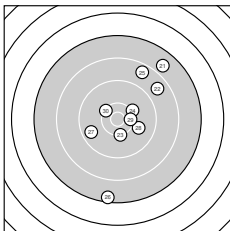

**Serie 3:**  
 7.8 ↗                      8.7 ↗                      10.2 ↓                      10.2 ↗                      8.6 ↗  
 7.4 ↓                      9.6 ←                      9.9 ↘                      10.4 \*                      10.3 ↘  
 beste Teiler: 460.0 (29.), 516.2 (30.), 566.7 (23.)  
 Trefferlage: 4.03 mm rechts, 1.16 mm hoch  
 Streuwert: 11.05, horizontal: 8.15, vertikal: 13.33



Ergebnis: **241.3** (228)  
 Serien: 83.9 73.6 83.8  
 Zähler: 1 8 8 7 4 1 1 0 0 0  
 Innenzehner: 0  
 Weitester: 4849 (25.), 4431 (20.), 3616 (15.)  
 beste Teiler: 627.4 (23.), 1046.7 (27.), 1101.4 (6.)  
 Trefferlage: 5.63 mm rechts, 4.20 mm hoch  
 Streuwert: 17.55, horizontal: 16.71, vertikal: 18.35

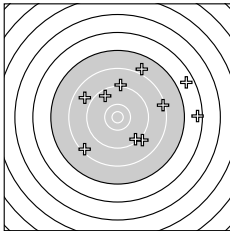
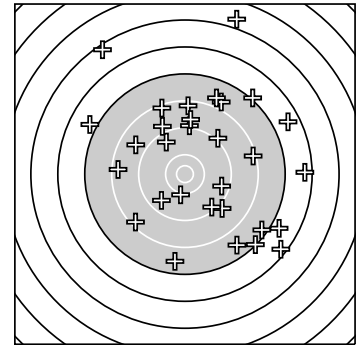

**Serie 1:**

8.0 ↗	9.1 ↘	9.4 ↘	6.7 ↗	8.3 →
9.6 ↘	8.8 ↖	8.4 ↙	6.5 →	9.1 ↑

beste Teiler: 1101.4 (6.), 1260.2 (3.), 1443.1 (10.)  
 Trefferlage: 8.26 mm rechts, 4.13 mm hoch  
 Streuwert: 14.95, horizontal: 17.29, vertikal: 12.17

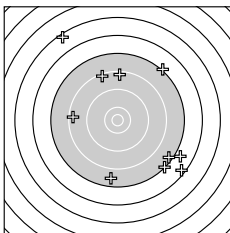

**Serie 2:**

7.2 ↗	8.4 ↖	7.3 ↘	8.4 ↑	6.4 ↘
7.7 ↓	7.4 ↘	6.9 ↘	8.5 ←	5.4 ↘

beste Teiler: 1990.8 (19.), 2031.0 (14.), 2078.4 (12.)  
 Trefferlage: 6.70 mm rechts, 0.09 mm tief  
 Streuwert: 21.56, horizontal: 19.88, vertikal: 23.13

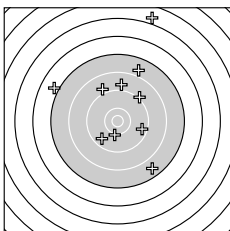

**Serie 3:**

7.7 ↘	8.9 ↑	10.2 ↓	7.9 ↗	4.9 ↑
7.0 ↖	9.6 ↙	9.5 →	9.0 ↘	9.1 ↗

beste Teiler: 627.4 (23.), 1046.7 (27.), 1145.4 (28.)  
 Trefferlage: 1.92 mm rechts, 8.58 mm hoch  
 Streuwert: 16.46, horizontal: 13.47, vertikal: 18.98



**Ergebnis: 285.7 (273)**  
**Serien: 97.5 94.4 93.8**  
**Zähler: 8 18 3 1 0 0 0 0 0 0**  
**Innenzehner: 4**  
**Weiteste: 2902 (20.), 2298 (29.), 1817 (25.)**  
**beste Teiler: 209.4 (12.), 299.0 (14.), 412.4 (19.)**  
**Trefferlage: 0.99 mm links, 3.81 mm tief**  
**Streuwert: 8.65, horizontal: 6.38, vertikal: 10.44**

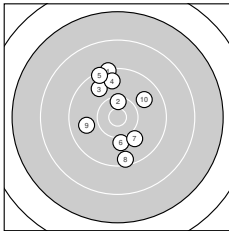
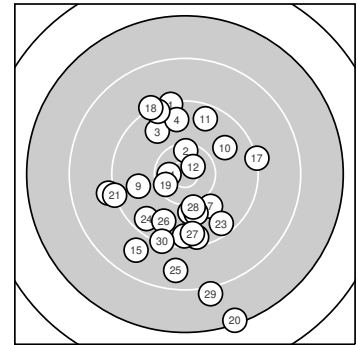

**Serie 1:**

9.3 ↑	10.4 *	9.8 ↘	9.7 ↑	9.3 ↘
10.0 ↓	10.0 ↘	9.4 ↓	9.8 ←	9.8 ↗

**beste Teiler: 440.2 (2.), 721.8 (6.), 772.1 (7.)**  
**Trefferlage: 0.77 mm links, 2.53 mm hoch**  
**Streuwert: 7.12, horizontal: 4.93, vertikal: 8.79**

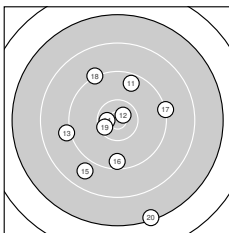

**Serie 2:**

9.6 ↗	10.7 *	9.1 ←	10.6 *	8.8 ↘
9.5 ↓	9.2 →	9.2 ↘	10.4 *	7.3 ↓

**beste Teiler: 209.4 (12.), 299.0 (14.), 412.4 (19.)**  
**Trefferlage: 0.84 mm links, 3.16 mm tief**  
**Streuwert: 10.33, horizontal: 8.40, vertikal: 11.95**

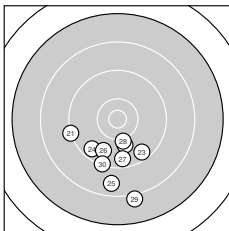

**Serie 3:**

9.2 ←	10.0 ↓	9.5 ↘	9.6 ↘	8.7 ↓
9.7 ↘	9.5 ↓	10.2 ↓	8.1 ↓	9.3 ↘

**beste Teiler: 637.3 (28.), 760.0 (22.), 967.6 (26.)**  
**Trefferlage: 1.38 mm links, 10.82 mm tief**  
**Streuwert: 5.82, horizontal: 6.00, vertikal: 5.63**



**Ergebnis: 272.0 (257)**  
**Serien: 90.2 87.2 94.6**  
**Zähler: 6 10 10 3 1 0 0 0 0 0**  
**Innenzehner: 4**  
**Weiteste: 3690 (10.), 3040 (7.), 2759 (20.)**  
**beste Teiler: 206.5 (9.), 229.4 (8.), 346.8 (26.)**  
**Trefferlage: 2.94 mm links, 1.02 mm hoch**  
**Streuwert: 12.19, horizontal: 7.48, vertikal: 15.53**

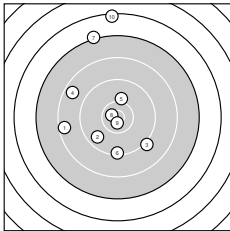
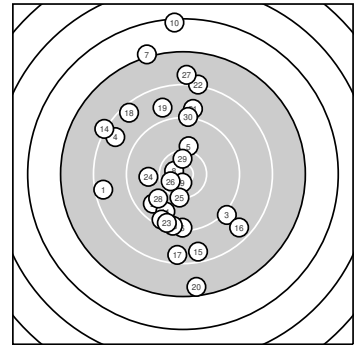

**Serie 1:**

8.5 ←	9.7 ↙	9.1 ↘	8.6 ↖	10.1 ↑
9.3 ↓	7.2 ↑	10.7 *	10.7 *	6.3 ↑

**beste Teiler: 206.5 (9.), 229.4 (8.), 692.6 (5.)**  
**Trefferlage: 4.43 mm links, 4.66 mm hoch**  
**Streuwert: 13.25, horizontal: 8.85, vertikal: 16.51**

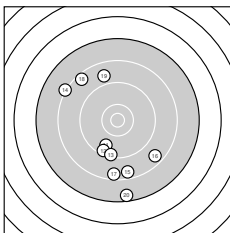

**Serie 2:**

9.7 ↙	9.4 ↙	9.4 ↓	8.2 ↖	8.6 ↓
8.6 ↘	8.5 ↓	8.5 ↖	8.8 ↑	7.5 ↓

**beste Teiler: 1004.2 (11.), 1221.6 (12.), 1278.0 (13.)**  
**Trefferlage: 2.99 mm links, 6.94 mm tief**  
**Streuwert: 12.65, horizontal: 9.05, vertikal: 15.44**

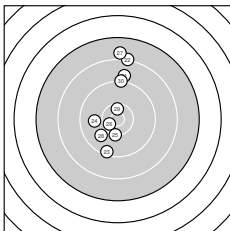

**Serie 3:**

8.9 ↑	8.2 ↑	9.4 ↓	9.9 ←	10.2 ↓
10.5 *	7.9 ↑	9.9 ↙	10.5 *	9.2 ↑

**beste Teiler: 346.8 (26.), 374.1 (29.), 576.3 (25.)**  
**Trefferlage: 1.41 mm links, 5.35 mm hoch**  
**Streuwert: 9.35, horizontal: 3.86, vertikal: 12.65**



Ergebnis: **312.7** (298)  
 Serien: 104.2 105.1 103.4  
 Zähler: 28 2 0 0 0 0 0 0 0 0  
 Innenzehner: 26  
 Weitesten: 284 (24.), 253 (10.), 221 (25.)  
 beste Teiler: 36.1 (16.), 46.8 (20.), 50.9 (19.)  
 Trefferlage: 0.30 mm links, 0.18 mm tief  
 Streuwert: 1.02, horizontal: 1.07, vertikal: 0.96

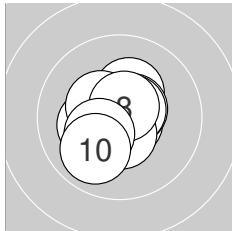
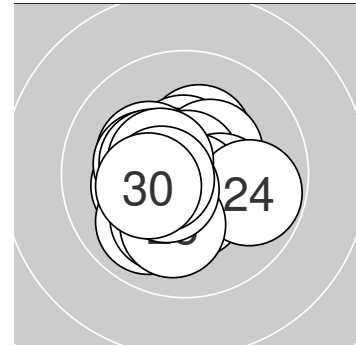

**Serie 1:**

10.3 *	10.2 *	10.7 *	10.6 *	10.6 *
10.5 *	10.4 *	10.7 *	10.3 *	9.9 ↙

beste Teiler: 59.6 (3.), 74.4 (8.), 85.1 (5.)  
 Trefferlage: 0.27 mm links, 0.09 mm tief  
 Streuwert: 1.06, horizontal: 1.04, vertikal: 1.07

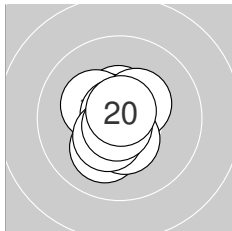

**Serie 2:**

10.1 ↙	10.5 *	10.6 *	10.4 *	10.3 *
10.8 *	10.4 *	10.4 *	10.8 *	10.8 *

beste Teiler: 36.1 (16.), 46.8 (20.), 50.9 (19.)  
 Trefferlage: 0.29 mm links, 0.06 mm tief  
 Streuwert: 0.91, horizontal: 0.72, vertikal: 1.06

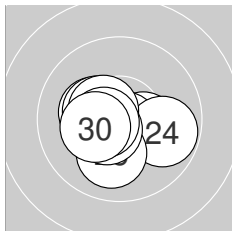

**Serie 3:**

10.3 *	10.7 *	10.3 *	9.8 →	10.1 ↙
10.5 *	10.4 *	10.5 *	10.5 *	10.3 *

beste Teiler: 58.3 (22.), 102.1 (29.), 103.7 (26.)  
 Trefferlage: 0.34 mm links, 0.38 mm tief  
 Streuwert: 1.17, horizontal: 1.44, vertikal: 0.80



Ergebnis: **310.2** (296)  
 Serien: 101.6 104.4 104.2  
 Zähler: 26 4 0 0 0 0 0 0 0  
 Innenzehner: 22  
 Weitest: 358 (6.), 328 (3.), 311 (8.)  
 beste Teiler: 18.9 (25.), 39.8 (17.), 50.2 (27.)  
 Trefferlage: 0.26 mm links, 0.31 mm hoch  
 Streuwert: 1.23, horizontal: 1.40, vertikal: 1.04

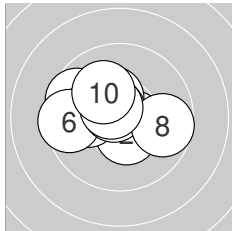
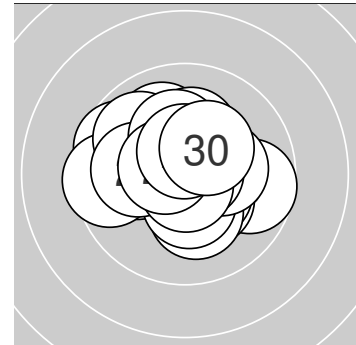

**Serie 1:**

10.5 *	10.5 *	9.6 ↖	10.4 *	10.0 ←
9.5 ←	10.7 *	9.7 →	10.6 *	10.1 ↗

beste Teiler: 61.7 (7.), 90.7 (9.), 108.8 (1.)  
 Trefferlage: 0.69 mm links, 0.33 mm hoch  
 Streuwert: 1.55, horizontal: 1.97, vertikal: 0.95

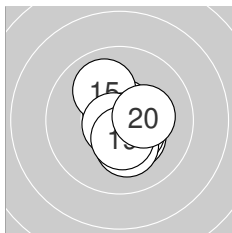

**Serie 2:**

10.6 *	10.3 *	10.7 *	10.4 *	10.0 ↘
10.2 *	10.8 *	10.7 *	10.4 *	10.3 *

beste Teiler: 39.8 (17.), 52.4 (18.), 68.4 (13.)  
 Trefferlage: 0.29 mm rechts, 0.19 mm tief  
 Streuwert: 1.00, horizontal: 0.82, vertikal: 1.16

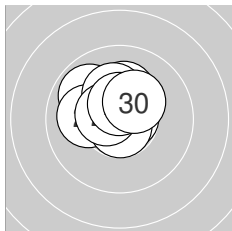

**Serie 3:**

9.9 ↘	10.2 *	10.1 ←	10.2 *	10.9 *
10.7 *	10.8 *	10.6 *	10.5 *	10.3 *

beste Teiler: 18.9 (25.), 50.2 (27.), 56.2 (26.)  
 Trefferlage: 0.38 mm links, 0.79 mm hoch  
 Streuwert: 0.96, horizontal: 1.08, vertikal: 0.83



Ergebnis: **312.3** (300)  
 Serien: 104.8 105.0 102.5  
 Zähler: 30 0 0 0 0 0 0 0 0  
 Innenzehner: 25  
 Weitesten: 229 (28.), 227 (23.), 227 (27.)  
 beste Teiler: 4.4 (30.), 20.6 (4.), 24.1 (19.)  
 Trefferlage: 0.23 mm links, 0.55 mm tief  
 Streuwert: 0.98, horizontal: 1.04, vertikal: 0.91

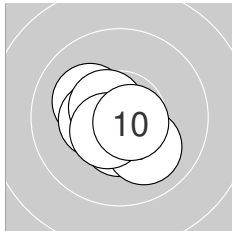
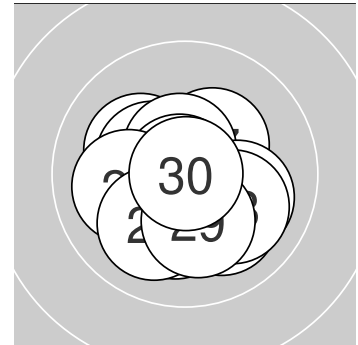

**Serie 1:**

10.5 *	10.2 *	10.4 *	10.9 *	10.4 *
10.6 *	10.0 ↘	10.6 *	10.5 *	10.7 *

beste Teiler: 20.6 (4.), 72.9 (10.), 96.6 (8.)  
 Trefferlage: 0.44 mm links, 0.30 mm tief  
 Streuwert: 0.90, horizontal: 0.95, vertikal: 0.85

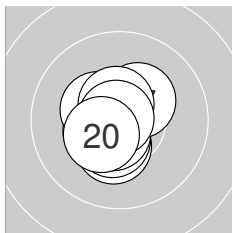

**Serie 2:**

10.6 *	10.4 *	10.3 *	10.5 *	10.4 *
10.6 *	10.3 *	10.6 *	10.9 *	10.4 *

beste Teiler: 24.1 (19.), 84.1 (16.), 96.3 (18.)  
 Trefferlage: 0.48 mm links, 0.16 mm tief  
 Streuwert: 0.82, horizontal: 0.68, vertikal: 0.93

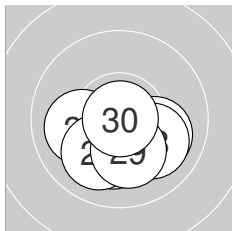

**Serie 3:**

10.3 *	10.0 ↘	10.0 ↘	10.2 *	10.5 *
10.4 *	10.0 ←	10.0 ↙	10.2 *	10.9 *

beste Teiler: 4.4 (30.), 118.4 (25.), 140.2 (26.)  
 Trefferlage: 0.22 mm rechts, 1.17 mm tief  
 Streuwert: 1.04, horizontal: 1.33, vertikal: 0.64





**Ergebnis:** **314.4** (299)  
**Serien:** 104.7 104.5 105.2  
**Zähler:** 29 1 0 0 0 0 0 0 0  
**Innenzehner:** 28  
**Weiteste:** 272 (4.), 245 (14.), 195 (16.)  
**beste Teiler:** 4.4 (7.), 21.0 (30.), 37.6 (20.)  
**Trefferlage:** 0.14 mm links, 0.35 mm tief  
**Streuwert:** 0.93, horizontal: 0.98, vertikal: 0.88

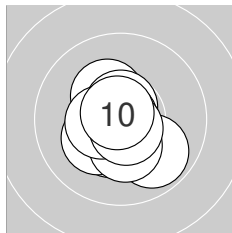
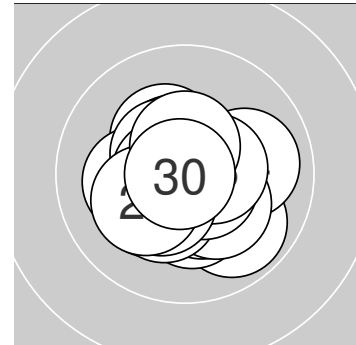

**Serie 1:**  
 10.4 \*                      10.3 \*                      10.2 \*                      9.9 ↘                      10.7 \*  
 10.3 \*                      10.9 \*                      10.5 \*                      10.7 \*                      10.8 \*  
**beste Teiler:** 4.4 (7.), 44.2 (10.), 65.5 (9.)  
**Trefferlage:** 0.15 mm links, 0.41 mm tief  
**Streuwert:** 1.02, horizontal: 0.94, vertikal: 1.09

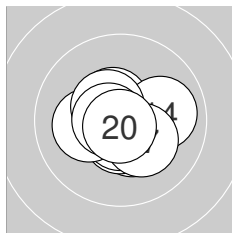

**Serie 2:**  
 10.4 \*                      10.5 \*                      10.5 \*                      10.0 →                      10.6 \*  
 10.2 \*                      10.3 \*                      10.5 \*                      10.7 \*                      10.8 \*  
**beste Teiler:** 37.6 (20.), 73.0 (19.), 82.0 (15.)  
**Trefferlage:** 0.03 mm rechts, 0.26 mm tief  
**Streuwert:** 1.03, horizontal: 1.21, vertikal: 0.81

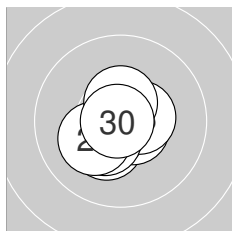

**Serie 3:**  
 10.3 \*                      10.4 \*                      10.6 \*                      10.6 \*                      10.8 \*  
 10.5 \*                      10.4 \*                      10.2 \*                      10.5 \*                      10.9 \*  
**beste Teiler:** 21.0 (30.), 44.9 (25.), 84.5 (23.)  
**Trefferlage:** 0.31 mm links, 0.37 mm tief  
**Streuwert:** 0.82, horizontal: 0.84, vertikal: 0.80



Ergebnis: **312.9** (298)  
 Serien: 104.6 104.4 103.9  
 Zähler: 28 2 0 0 0 0 0 0 0 0  
 Innenzehner: 25  
 Weitestе: 263 (16.), 251 (30.), 250 (7.)  
 beste Teiler: 35.7 (20.), 39.0 (1.), 62.3 (8.)  
 Trefferlage: 0.05 mm rechts, 0.37 mm tief  
 Streuwert: 1.01, horizontal: 1.09, vertikal: 0.92

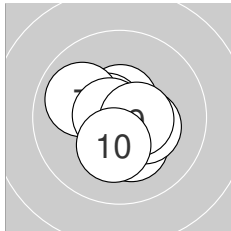
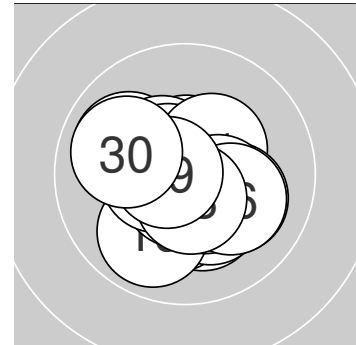

**Serie 1:**

10.8 *	10.6 *	10.6 *	10.2 *	10.3 *
10.6 *	10.0 ↖	10.7 *	10.5 *	10.3 *

beste Teiler: 39.0 (1.), 62.3 (8.), 89.6 (3.)  
 Trefferlage: 0.00 mm , 0.22 mm tief  
 Streuwert: 1.01, horizontal: 1.07, vertikal: 0.95

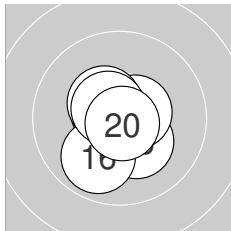

**Serie 2:**

10.4 *	10.6 *	10.4 *	10.4 *	10.3 *
9.9 ↙	10.6 *	10.4 *	10.6 *	10.8 *

beste Teiler: 35.7 (20.), 79.1 (12.), 90.7 (19.)  
 Trefferlage: 0.13 mm links, 0.55 mm tief  
 Streuwert: 0.95, horizontal: 0.80, vertikal: 1.08

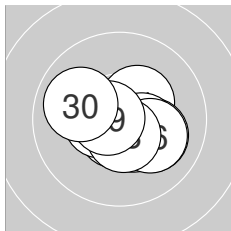

**Serie 3:**

10.4 *	10.7 *	10.1 ↘	10.5 *	10.4 *
10.1 ↘	10.5 *	10.6 *	10.7 *	9.9 ↖

beste Teiler: 72.3 (29.), 75.6 (22.), 99.9 (28.)  
 Trefferlage: 0.27 mm rechts, 0.33 mm tief  
 Streuwert: 1.12, horizontal: 1.39, vertikal: 0.77



Ergebnis: **311.6** (300)  
 Serien: 104.7 104.1 102.8  
 Zähler: 30 0 0 0 0 0 0 0 0  
 Innenzehner: 24  
 Weitesten: 242 (30.), 229 (25.), 226 (21.)  
 beste Teiler: 21.9 (23.), 35.9 (9.), 36.2 (14.)  
 Trefferlage: 0.30 mm rechts, 0.00 mm  
 Streuwert: 1.08, horizontal: 1.23, vertikal: 0.90

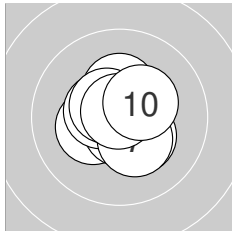
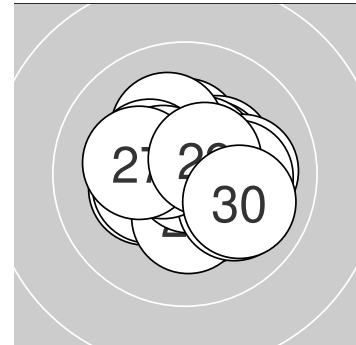

**Serie 1:**

10.3 *	10.3 *	10.7 *	10.3 *	10.5 *
10.7 *	10.3 *	10.5 *	10.8 *	10.3 *

beste Teiler: 35.9 (9.), 66.4 (6.), 68.3 (3.)  
 Trefferlage: 0.05 mm rechts, 0.00 mm  
 Streuwert: 0.94, horizontal: 0.97, vertikal: 0.92

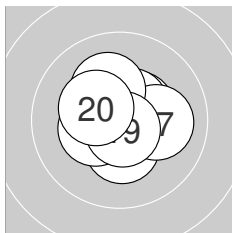

**Serie 2:**

10.3 *	10.5 *	10.3 *	10.8 *	10.4 *
10.5 *	10.1 →	10.2 *	10.7 *	10.3 *

beste Teiler: 36.2 (14.), 56.9 (19.), 107.6 (16.)  
 Trefferlage: 0.01 mm links, 0.27 mm hoch  
 Streuwert: 1.06, horizontal: 1.14, vertikal: 0.96

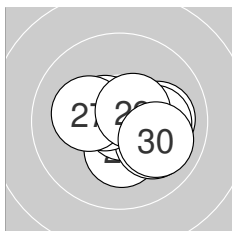

**Serie 3:**

10.0 →	10.3 *	10.9 *	10.1 →	10.0 →
10.6 *	10.2 *	10.1 →	10.6 *	10.0 →

beste Teiler: 21.9 (23.), 99.2 (29.), 99.3 (26.)  
 Trefferlage: 0.89 mm rechts, 0.30 mm tief  
 Streuwert: 1.17, horizontal: 1.45, vertikal: 0.80



Ergebnis: **287.4** (274)  
 Serien: 95.7 95.9 95.8  
 Zähler: 12 11 6 1 0 0 0 0 0 0  
 Innenzehner: 9  
 Weitestе: 771 (15.), 685 (30.), 592 (4.)  
 beste Teiler: 57.3 (11.), 67.2 (12.), 83.7 (7.)  
 Trefferlage: 0.39 mm links, 0.76 mm tief  
 Streuwert: 2.76, horizontal: 3.12, vertikal: 2.35

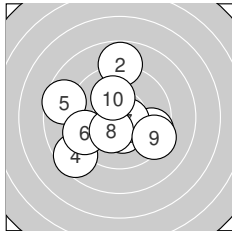
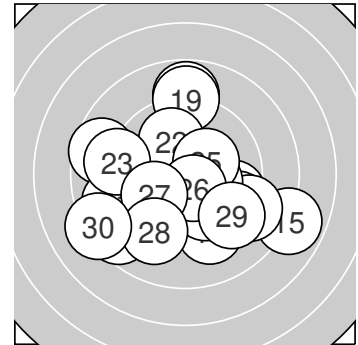

**Serie 1:**  
 10.4 \*                      8.8 ↑                      9.6 ↘                      8.6 ↙                      8.6 ←  
                                  9.4 ↙                      10.6 \*                      10.3 \*                      9.3 ↘                      10.1 ↑  
 beste Teiler: 83.7 (7.), 144.1 (1.), 160.7 (8.)  
 Trefferlage: 0.73 mm links, 0.29 mm tief  
 Streuwert: 2.84, horizontal: 3.05, vertikal: 2.61

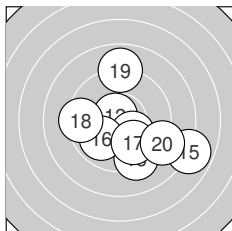

**Serie 2:**  
 10.7 \*                      10.7 \*                      9.3 ↓                      10.2 \*                      7.9 ↘  
                                  9.9 ↙                      9.9 ↓                      9.4 ←                      8.9 ↑                      9.0 ↘  
 beste Teiler: 57.3 (11.), 67.2 (12.), 186.6 (14.)  
 Trefferlage: 0.90 mm rechts, 0.89 mm tief  
 Streuwert: 2.84, horizontal: 3.09, vertikal: 2.55

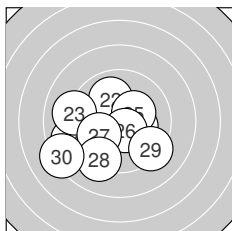

**Serie 3:**  
                                  8.9 ↙                      10.0 ↑                      9.1 ←                      10.3 \*                      10.3 \*  
                                  10.5 \*                      10.0 ↙                      9.2 ↙                      9.3 ↘                      8.2 ↙  
 beste Teiler: 110.2 (26.), 166.3 (25.), 174.2 (24.)  
 Trefferlage: 1.34 mm links, 1.10 mm tief  
 Streuwert: 2.59, horizontal: 3.07, vertikal: 2.01



**Ergebnis:** 310.1 (296)  
**Serien:** 101.9 103.1 105.1  
**Zähler:** 26 4 0 0 0 0 0 0 0  
**Innenzehner:** 22  
**Weiteste:** 422 (10.), 326 (6.), 268 (17.)  
**beste Teiler:** 12.0 (24.), 54.1 (3.), 59.1 (23.)  
**Trefferlage:** 0.50 mm links, 0.15 mm hoch  
**Streuwert:** 1.21, horizontal: 1.11, vertikal: 1.29

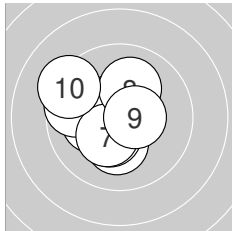
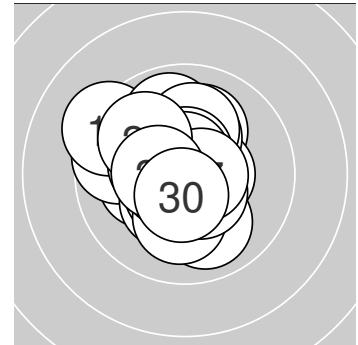

**Serie 1:**

10.6 *	10.2 *	10.7 *	10.4 *	10.2 *
9.6 ↙	10.3 *	10.1 ↑	10.5 *	9.3 ↘

**beste Teiler:** 54.1 (3.), 97.0 (1.), 110.0 (9.)  
**Trefferlage:** 0.88 mm links, 0.15 mm hoch  
**Streuwert:** 1.48, horizontal: 1.57, vertikal: 1.38

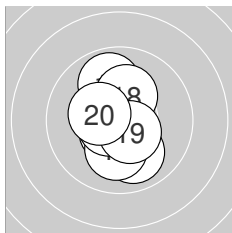

**Serie 2:**

10.0 ↓	10.4 *	10.6 *	10.5 *	10.1 ↓
10.6 *	9.9 ↑	10.2 *	10.5 *	10.3 *

**beste Teiler:** 83.3 (16.), 95.6 (13.), 106.0 (14.)  
**Trefferlage:** 0.32 mm links, 0.20 mm tief  
**Streuwert:** 1.23, horizontal: 0.82, vertikal: 1.54

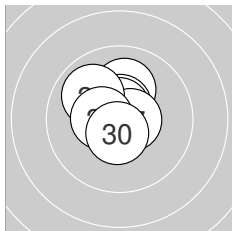

**Serie 3:**

10.7 *	10.1 ↑	10.7 *	10.9 *	10.6 *
10.7 *	10.6 *	9.9 ↘	10.4 *	10.5 *

**beste Teiler:** 12.0 (24.), 59.1 (23.), 60.8 (21.)  
**Trefferlage:** 0.31 mm links, 0.52 mm hoch  
**Streuwert:** 0.84, horizontal: 0.78, vertikal: 0.90



**Ergebnis:** **303.5** (292)  
**Serien:** 99.9 102.4 101.2  
**Zähler:** 23 6 1 0 0 0 0 0 0  
**Innenzehner:** 16  
**Weiteste:** 516 (23.), 424 (10.), 353 (15.)  
**beste Teiler:** 55.4 (19.), 60.4 (12.), 75.4 (13.)  
**Trefferlage:** 1.05 mm links, 0.62 mm tief  
**Streuwert:** 1.44, horizontal: 1.63, vertikal: 1.22

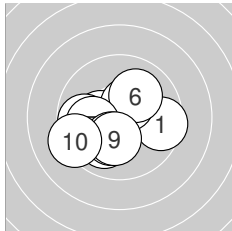
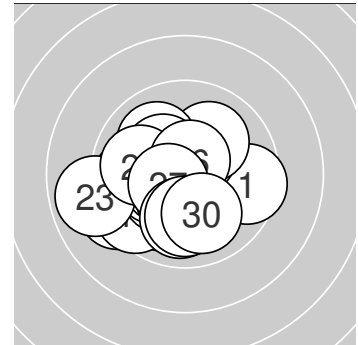

**Serie 1:**

9.5 →	10.3 *	9.8 ←	10.5 *	10.0 ↙
10.1 ↗	10.0 ←	10.2 *	10.2 *	9.3 ←

**beste Teiler:** 124.6 (4.), 161.0 (2.), 184.8 (9.)  
**Trefferlage:** 0.75 mm links, 0.60 mm tief  
**Streuwert:** 1.78, horizontal: 2.15, vertikal: 1.33

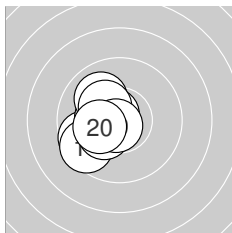

**Serie 2:**

9.6 ←	10.7 *	10.7 *	10.3 *	9.5 ↙
10.0 ↘	10.3 *	10.3 *	10.7 *	10.3 *

**beste Teiler:** 55.4 (19.), 60.4 (12.), 75.4 (13.)  
**Trefferlage:** 1.43 mm links, 0.24 mm tief  
**Streuwert:** 1.05, horizontal: 0.89, vertikal: 1.19

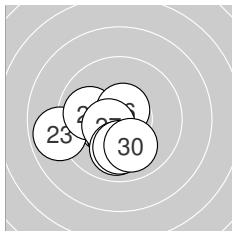

**Serie 3:**

10.4 *	10.5 *	8.9 ←	10.4 *	9.9 ←
10.6 *	10.5 *	10.0 ↓	10.0 ↓	10.0 ↘

**beste Teiler:** 81.9 (26.), 106.4 (22.), 107.5 (27.)  
**Trefferlage:** 0.98 mm links, 1.02 mm tief  
**Streuwert:** 1.44, horizontal: 1.69, vertikal: 1.13



Ergebnis: **315.1** (299)  
 Serien: 104.6 104.5 106.0  
 Zähler: 29 1 0 0 0 0 0 0 0 0  
 Innenzehner: 29  
 Weitesten: 281 (17.), 199 (7.), 197 (3.)  
 beste Teiler: 36.7 (27.), 39.3 (1.), 41.1 (10.)  
 Trefferlage: 0.07 mm links, 0.05 mm tief  
 Streuwert: 0.92, horizontal: 1.06, vertikal: 0.75

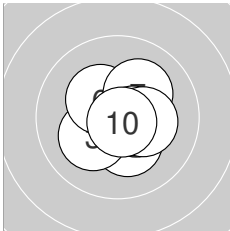
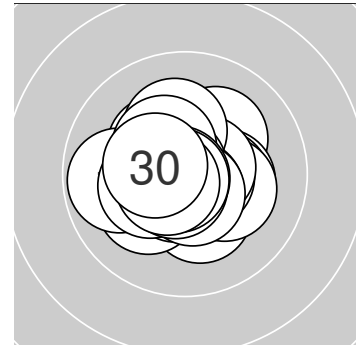

**Serie 1:**

10.8 *	10.3 *	10.2 *	10.5 *	10.7 *
10.3 *	10.2 *	10.5 *	10.3 *	10.8 *

beste Teiler: 39.3 (1.), 41.1 (10.), 61.8 (5.)  
 Trefferlage: 0.33 mm rechts, 0.09 mm tief  
 Streuwert: 1.00, horizontal: 1.06, vertikal: 0.94

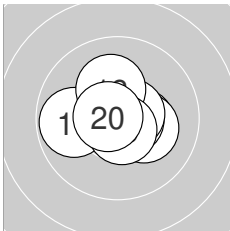

**Serie 2:**

10.8 *	10.5 *	10.4 *	10.2 *	10.7 *
10.6 *	9.8 ←	10.2 *	10.6 *	10.7 *

beste Teiler: 47.1 (11.), 62.8 (20.), 74.6 (15.)  
 Trefferlage: 0.04 mm rechts, 0.09 mm hoch  
 Streuwert: 1.07, horizontal: 1.32, vertikal: 0.74

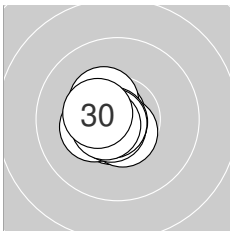

**Serie 3:**

10.8 *	10.4 *	10.6 *	10.6 *	10.3 *
10.7 *	10.8 *	10.8 *	10.6 *	10.4 *

beste Teiler: 36.7 (27.), 44.4 (28.), 50.1 (21.)  
 Trefferlage: 0.59 mm links, 0.15 mm tief  
 Streuwert: 0.56, horizontal: 0.52, vertikal: 0.59



Ergebnis: **301.5** (287)  
 Serien: 96.2 103.0 102.3  
 Zähler: 20 7 3 0 0 0 0 0 0  
 Innenzehner: 16  
 Weitestе: 693 (9.), 568 (4.), 567 (6.)  
 beste Teiler: 19.0 (19.), 29.1 (17.), 59.1 (30.)  
 Trefferlage: 0.67 mm rechts, 0.62 mm tief  
 Streuwert: 1.87, horizontal: 2.20, vertikal: 1.46

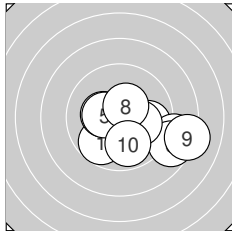
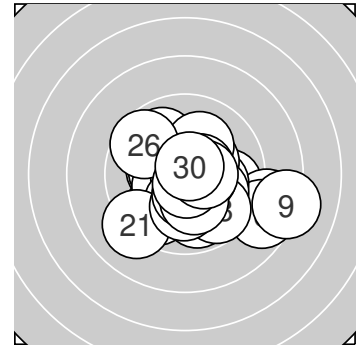

**Serie 1:**

9.7 ↙	9.8 →	10.3 *	8.7 →	10.4 *
8.7 ↘	10.1 →	10.4 *	8.2 →	9.9 ↓

beste Teiler: 126.6 (8.), 147.6 (5.), 163.4 (3.)  
 Trefferlage: 1.83 mm rechts, 1.10 mm tief  
 Streuwert: 2.38, horizontal: 3.08, vertikal: 1.36

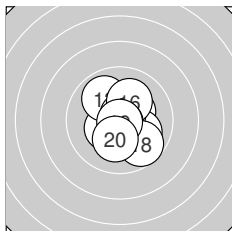

**Serie 2:**

10.3 *	10.4 *	9.9 ↘	10.0 ↘	10.7 *
10.1 ↗	10.8 *	9.7 ↘	10.9 *	10.2 *

beste Teiler: 19.0 (19.), 29.1 (17.), 59.3 (15.)  
 Trefferlage: 0.35 mm rechts, 0.12 mm tief  
 Streuwert: 1.35, horizontal: 1.22, vertikal: 1.47

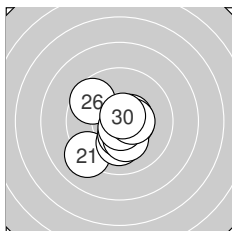

**Serie 3:**

9.1 ↙	10.1 ↓	10.4 *	10.5 *	10.2 *
9.6 ↘	10.7 *	10.5 *	10.5 *	10.7 *

beste Teiler: 59.1 (30.), 64.1 (27.), 106.4 (28.)  
 Trefferlage: 0.14 mm links, 0.64 mm tief  
 Streuwert: 1.52, horizontal: 1.53, vertikal: 1.51





Ergebnis: **303.1** (289)  
 Serien: 101.3 98.9 102.9  
 Zähler: 19 11 0 0 0 0 0 0 0 0  
 Innenzehner: 18  
 Weitestе: 393 (14.), 385 (17.), 333 (19.)  
 beste Teiler: 6.3 (4.), 68.1 (25.), 91.7 (20.)  
 Trefferlage: 0.48 mm links, 0.05 mm tief  
 Streuwert: 1.64, horizontal: 1.76, vertikal: 1.50

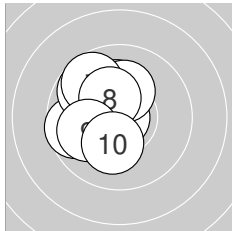
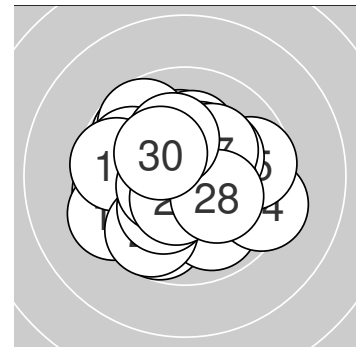

**Serie 1:**

9.6 ←	10.2 *	10.4 *	10.9 *	9.8 ↖
10.2 *	9.7 ↘	10.3 *	10.0 ←	10.2 *

beste Teiler: 6.3 (4.), 136.4 (3.), 155.6 (8.)  
 Trefferlage: 1.15 mm links, 0.47 mm hoch  
 Streuwert: 1.40, horizontal: 1.18, vertikal: 1.59

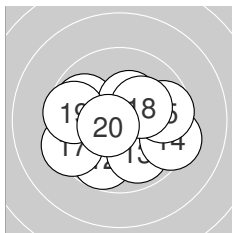

**Serie 2:**

9.9 ↖	9.8 ↙	9.9 ↘	9.4 →	9.7 →
10.4 *	9.4 ←	10.2 *	9.6 ←	10.6 *

beste Teiler: 91.7 (20.), 150.7 (16.), 182.1 (18.)  
 Trefferlage: 0.09 mm links, 0.40 mm tief  
 Streuwert: 2.11, horizontal: 2.56, vertikal: 1.53

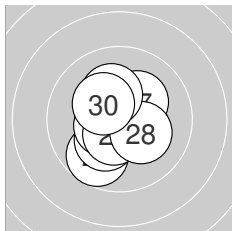

**Serie 3:**

9.7 ↙	10.2 *	10.5 *	10.4 *	10.7 *
10.5 *	10.2 *	10.2 *	10.2 *	10.3 *

beste Teiler: 68.1 (25.), 114.9 (26.), 116.8 (23.)  
 Trefferlage: 0.22 mm links, 0.23 mm tief  
 Streuwert: 1.27, horizontal: 1.15, vertikal: 1.38



**Ergebnis: 310.2** (296)  
**Serien:** 103.7 103.4 103.1  
**Zähler:** 26 4 0 0 0 0 0 0 0 0  
**Innenzehner:** 19  
**Weiteste:** 341 (7.), 277 (10.), 274 (25.)  
**beste Teiler:** 10.0 (11.), 23.0 (3.), 28.6 (22.)  
**Trefferlage:** 0.06 mm rechts, 0.45 mm tief  
**Streuwert:** 1.22, horizontal: 1.17, vertikal: 1.27

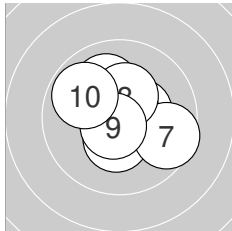
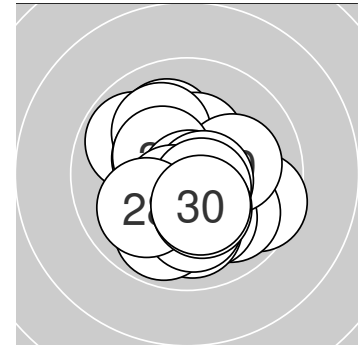

**Serie 1:**

10.4 *	10.1 ↘	10.9 *	10.7 *	10.7 *
10.4 *	9.6 ↗	10.4 *	10.7 *	9.8 ↖

**beste Teiler:** 23.0 (3.), 52.3 (5.), 73.0 (9.)  
**Trefferlage:** 0.10 mm rechts, 0.26 mm hoch  
**Streuwert:** 1.32, horizontal: 1.45, vertikal: 1.17

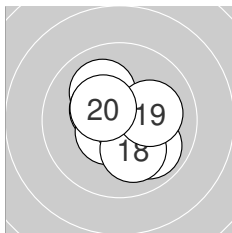

**Serie 2:**

10.9 *	10.3 *	9.9 ↘	10.7 *	10.1 ↘
10.4 *	10.5 *	10.1 ↘	10.1 →	10.4 *

**beste Teiler:** 10.0 (11.), 70.3 (14.), 108.1 (17.)  
**Trefferlage:** 0.09 mm rechts, 0.26 mm tief  
**Streuwert:** 1.24, horizontal: 1.24, vertikal: 1.25

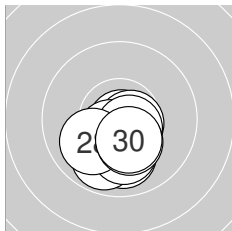

**Serie 3:**

10.0 ↓	10.8 *	10.6 *	10.5 *	9.9 ↙
10.6 *	10.1 ↓	10.0 ↙	10.3 *	10.3 *

**beste Teiler:** 28.6 (22.), 80.4 (23.), 89.8 (26.)  
**Trefferlage:** 0.01 mm links, 1.37 mm tief  
**Streuwert:** 0.85, horizontal: 0.87, vertikal: 0.84



Ergebnis: **304.1** (292)  
 Serien: 100.1 101.1 102.9  
 Zähler: 22 8 0 0 0 0 0 0 0 0  
 Innenzehner: 16  
 Weitest: 457 (13.), 364 (6.), 330 (30.)  
 beste Teiler: 58.6 (29.), 80.6 (27.), 95.1 (22.)  
 Trefferlage: 0.36 mm rechts, 0.14 mm tief  
 Streuwert: 1.59, horizontal: 1.66, vertikal: 1.53

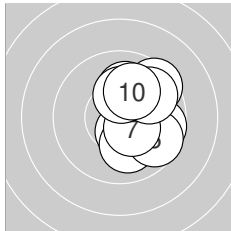
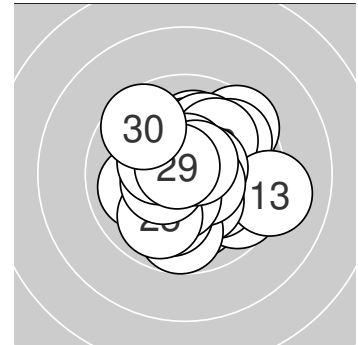

**Serie 1:**

10.5 *	10.1 ↓	10.1 ↑	9.7 →	9.7 →
9.5 ↗	10.4 *	9.8 ↗	10.2 *	10.1 ↑

beste Teiler: 117.1 (1.), 129.0 (7.), 177.5 (9.)  
 Trefferlage: 1.43 mm rechts, 0.36 mm hoch  
 Streuwert: 1.51, horizontal: 1.15, vertikal: 1.81

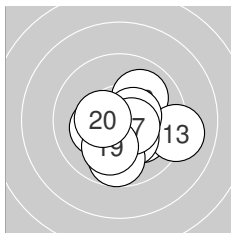

**Serie 2:**

10.2 *	10.0 ↗	9.1 →	10.3 *	9.8 ↓
10.5 *	10.5 *	10.2 *	10.1 ↓	10.4 *

beste Teiler: 104.6 (17.), 112.2 (16.), 133.3 (20.)  
 Trefferlage: 0.65 mm rechts, 0.74 mm tief  
 Streuwert: 1.58, horizontal: 1.80, vertikal: 1.32

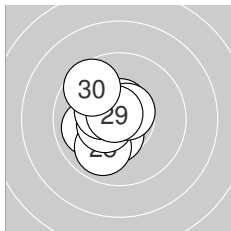

**Serie 3:**

10.4 *	10.6 *	10.2 *	10.0 ←	9.9 ↘
10.5 *	10.6 *	10.4 *	10.7 *	9.6 ↘

beste Teiler: 58.6 (29.), 80.6 (27.), 95.1 (22.)  
 Trefferlage: 0.99 mm links, 0.04 mm tief  
 Streuwert: 1.15, horizontal: 0.94, vertikal: 1.33



Ergebnis: **303.9** (293)  
 Serien: 100.6 100.3 103.0  
 Zähler: 24 5 1 0 0 0 0 0 0 0  
 Innenzehner: 16  
 Weitester: 526 (13.), 399 (5.), 383 (25.)  
 beste Teiler: 65.1 (27.), 69.3 (30.), 90.0 (22.)  
 Trefferlage: 0.39 mm links, 0.09 mm hoch  
 Streuwert: 1.62, horizontal: 1.58, vertikal: 1.66

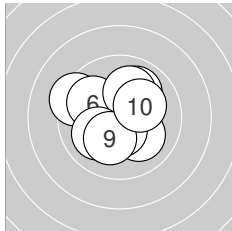
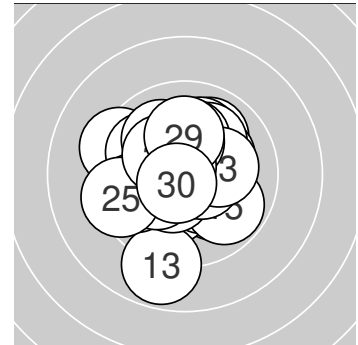

**Serie 1:**

10.2 *	10.1 ↘	10.5 *	10.0 ↗	9.4 ↖
9.9 ↙	10.1 ↗	10.0 ↖	10.2 *	10.2 *

beste Teiler: 111.3 (3.), 182.6 (1.), 194.6 (9.)  
 Trefferlage: 0.47 mm links, 0.25 mm hoch  
 Streuwert: 1.72, horizontal: 1.87, vertikal: 1.54

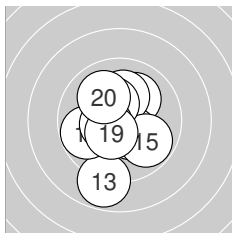

**Serie 2:**

10.1 ↗	10.4 *	8.8 ↓	10.1 ↑	9.8 ↘
10.4 *	9.8 ↖	10.5 *	10.4 *	10.0 ↖

beste Teiler: 119.6 (18.), 126.1 (19.), 147.3 (12.)  
 Trefferlage: 0.31 mm links, 0.32 mm tief  
 Streuwert: 1.89, horizontal: 1.49, vertikal: 2.22

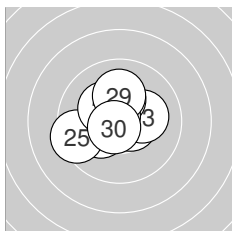

**Serie 3:**

10.6 *	10.6 *	10.2 *	10.2 *	9.4 ↖
10.2 *	10.7 *	10.3 *	10.1 ↑	10.7 *

beste Teiler: 65.1 (27.), 69.3 (30.), 90.0 (22.)  
 Trefferlage: 0.39 mm links, 0.35 mm hoch  
 Streuwert: 1.34, horizontal: 1.53, vertikal: 1.13



**Ergebnis:** **299.1** (287)  
**Serien:** 99.5 98.0 101.6  
**Zähler:** 18 11 1 0 0 0 0 0 0 0  
**Innenzehner:** 13  
**Weiteste:** 555 (5.), 491 (14.), 463 (11.)  
**beste Teiler:** 51.0 (6.), 85.1 (1.), 103.1 (29.)  
**Trefferlage:** 0.47 mm links, 0.21 mm tief  
**Streuwert:** 1.94, horizontal: 2.23, vertikal: 1.59

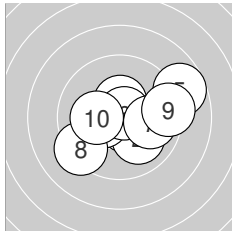
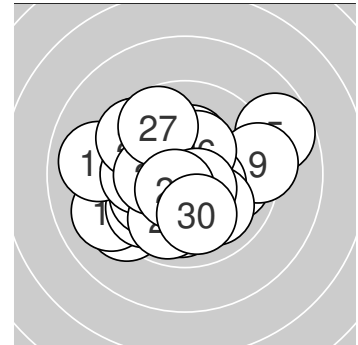

**Serie 1:**

10.6 *	10.0 ↘	10.4 *	10.4 *	8.7 →
10.7 *	9.9 →	9.3 ↙	9.3 →	10.2 *

**beste Teiler:** 51.0 (6.), 85.1 (1.), 129.0 (3.)  
**Trefferlage:** 0.75 mm rechts, 0.13 mm tief  
**Streuwert:** 2.12, horizontal: 2.64, vertikal: 1.41

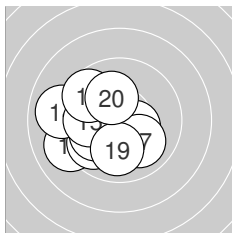

**Serie 2:**

9.1 ↙	9.8 ↙	10.0 ↙	9.0 ←	9.9 ←
10.4 *	10.0 ↘	9.6 ↘	10.0 ↓	10.2 *

**beste Teiler:** 132.4 (16.), 199.5 (20.), 232.7 (13.)  
**Trefferlage:** 1.63 mm links, 0.52 mm tief  
**Streuwert:** 1.90, horizontal: 2.12, vertikal: 1.64

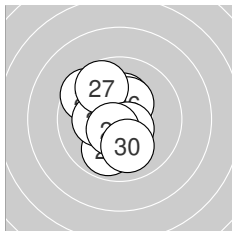

**Serie 3:**

9.6 ↘	9.9 ↙	10.5 *	10.2 *	10.3 *
10.4 *	9.7 ↘	10.5 *	10.5 *	10.0 ↓

**beste Teiler:** 103.1 (29.), 103.7 (28.), 108.0 (23.)  
**Trefferlage:** 0.53 mm links, 0.01 mm hoch  
**Streuwert:** 1.54, horizontal: 1.19, vertikal: 1.81



**Ergebnis:** **308.5** (296)  
**Serien:** 103.5 101.9 103.1  
**Zähler:** 26 4 0 0 0 0 0 0 0 0  
**Innenzehner:** 18  
**Weiteste:** 374 (12.), 299 (11.), 284 (30.)  
**beste Teiler:** 25.1 (17.), 36.4 (9.), 75.1 (14.)  
**Trefferlage:** 0.01 mm rechts, 0.58 mm hoch  
**Streuwert:** 1.28, horizontal: 1.48, vertikal: 1.02

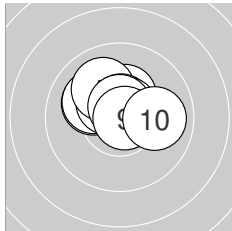
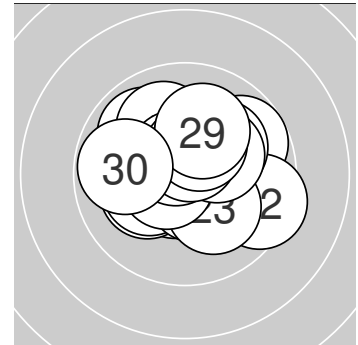

**Serie 1:**

10.1 ↖	10.1 ↖	10.4 *	10.3 *	10.0 ↘
10.6 *	10.6 *	10.6 *	10.8 *	10.0 →

**beste Teiler:** 36.4 (9.), 76.4 (7.), 77.0 (8.)  
**Trefferlage:** 0.19 mm links, 0.86 mm hoch  
**Streuwert:** 1.02, horizontal: 1.29, vertikal: 0.63

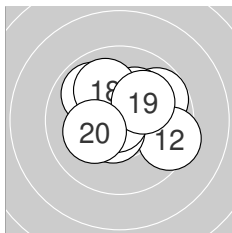

**Serie 2:**

9.8 ↗	9.5 ↘	9.9 ↖	10.7 *	10.6 *
10.2 *	10.9 *	10.0 ↘	10.1 ↗	10.2 *

**beste Teiler:** 25.1 (17.), 75.1 (14.), 90.5 (15.)  
**Trefferlage:** 0.31 mm rechts, 0.59 mm hoch  
**Streuwert:** 1.56, horizontal: 1.83, vertikal: 1.24

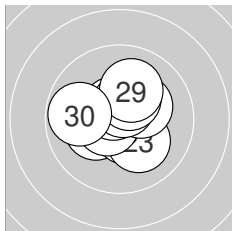

**Serie 3:**

10.2 *	10.5 *	10.1 ↘	10.6 *	10.3 *
10.6 *	10.6 *	10.3 *	10.1 ↗	9.8 ←

**beste Teiler:** 87.3 (26.), 92.8 (24.), 98.2 (27.)  
**Trefferlage:** 0.07 mm links, 0.29 mm hoch  
**Streuwert:** 1.26, horizontal: 1.38, vertikal: 1.13



**Ergebnis:** **305.9** (293)  
**Serien:** 102.5 101.3 102.1  
**Zähler:** 23 7 0 0 0 0 0 0 0 0  
**Innenzehner:** 18  
**Weiteste:** 476 (14.), 430 (3.), 373 (20.)  
**beste Teiler:** 4.1 (16.), 27.8 (13.), 32.5 (5.)  
**Trefferlage:** 0.00 mm , 0.02 mm tief  
**Streuwert:** 1.59, horizontal: 1.84, vertikal: 1.29

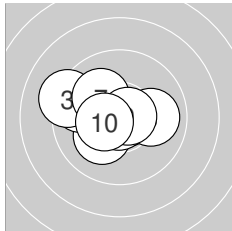
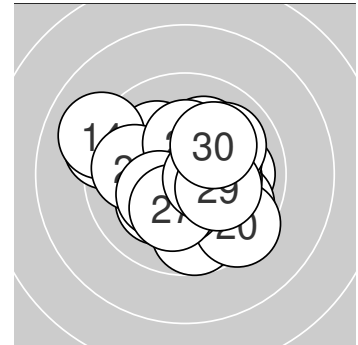

**Serie 1:**

10.2 *	9.7 ↖	9.2 ↖	10.7 *	10.8 *
10.6 *	10.1 ↘	10.0 →	10.7 *	10.5 *

**beste Teiler:** 32.5 (5.), 53.1 (4.), 64.4 (9.)  
**Trefferlage:** 0.84 mm links, 0.24 mm hoch  
**Streuwert:** 1.47, horizontal: 1.86, vertikal: 0.91

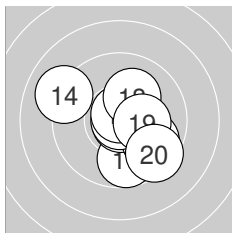

**Serie 2:**

9.7 ↓	10.5 *	10.8 *	9.0 ↖	9.8 ↘
10.9 *	10.8 *	10.1 ↗	10.2 *	9.5 ↘

**beste Teiler:** 4.1 (16.), 27.8 (13.), 48.0 (17.)  
**Trefferlage:** 0.52 mm rechts, 0.37 mm tief  
**Streuwert:** 1.81, horizontal: 1.96, vertikal: 1.65

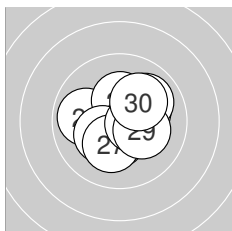

**Serie 3:**

10.2 *	10.4 *	9.9 ↖	10.3 *	10.0 ↗
10.3 *	10.2 *	10.5 *	10.2 *	10.1 ↗

**beste Teiler:** 110.6 (28.), 138.4 (22.), 161.0 (24.)  
**Trefferlage:** 0.32 mm rechts, 0.05 mm hoch  
**Streuwert:** 1.40, horizontal: 1.54, vertikal: 1.25



Ergebnis: **304.5** (292)  
 Serien: 102.0 101.3 101.2  
 Zähler: 22 8 0 0 0 0 0 0 0  
 Innenzehner: 19  
 Weitester: 482 (18.), 394 (28.), 311 (27.)  
 beste Teiler: 21.9 (21.), 26.9 (13.), 60.8 (8.)  
 Trefferlage: 0.66 mm links, 0.02 mm tief  
 Streuwert: 1.53, horizontal: 1.74, vertikal: 1.28

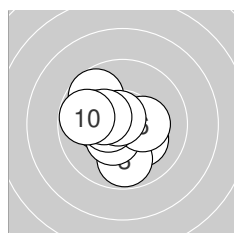
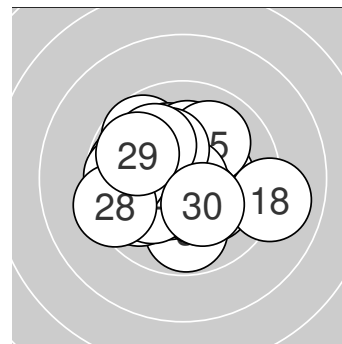

**Serie 1:**

10.3 *	10.2 *	9.8 ↓	10.4 *	9.7 ↘
10.3 *	10.5 *	10.7 *	10.3 *	9.8 ←

beste Teiler: 60.8 (8.), 115.0 (7.), 132.4 (4.)  
 Trefferlage: 0.72 mm links, 0.11 mm tief  
 Streuwert: 1.41, horizontal: 1.48, vertikal: 1.34

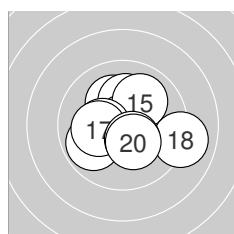

**Serie 2:**

10.2 *	10.2 *	10.8 *	9.9 ↙	10.0 ↗
10.3 *	10.2 *	9.0 →	10.4 *	10.3 *

beste Teiler: 26.9 (13.), 137.3 (19.), 160.0 (20.)  
 Trefferlage: 0.13 mm rechts, 0.04 mm hoch  
 Streuwert: 1.75, horizontal: 2.04, vertikal: 1.39

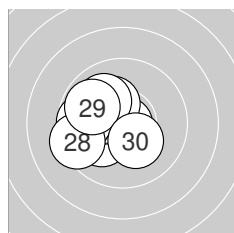

**Serie 3:**

10.9 *	10.6 *	10.3 *	10.1 ↙	10.2 *
10.0 ↘	9.7 ←	9.4 ↙	9.8 ↘	10.2 *

beste Teiler: 21.9 (21.), 97.7 (22.), 159.3 (23.)  
 Trefferlage: 1.42 mm links, 0.00 mm  
 Streuwert: 1.34, horizontal: 1.44, vertikal: 1.23





**Ergebnis: 310.4 (295)**  
**Serien: 101.8 103.6 105.0**  
**Zähler: 25 5 0 0 0 0 0 0 0 0**  
**Innenzehner: 22**  
**Weiteste: 316 (24.), 308 (5.), 306 (8.)**  
**beste Teiler: 7.2 (20.), 38.8 (28.), 43.8 (29.)**  
**Trefferlage: 0.46 mm links, 0.52 mm tief**  
**Streuwert: 1.15, horizontal: 1.28, vertikal: 1.00**

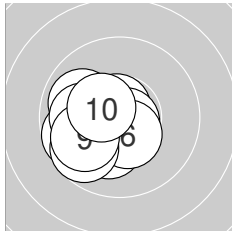
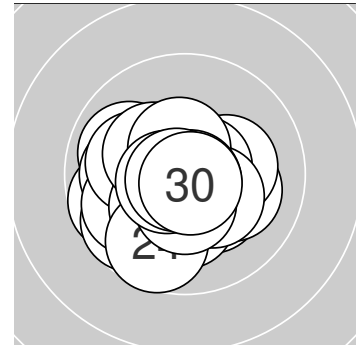

**Serie 1:**

9.9 ↖	10.2 *	10.7 *	10.8 *	9.7 ↖
10.5 *	10.0 ←	9.7 ↙	9.9 ↙	10.4 *

**beste Teiler: 48.2 (4.), 62.2 (3.), 123.0 (6.)**  
**Trefferlage: 1.34 mm links, 0.55 mm tief**  
**Streuwert: 1.17, horizontal: 1.27, vertikal: 1.06**

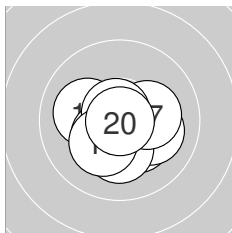

**Serie 2:**

10.5 *	10.1 ↖	10.3 *	10.1 ↗	10.2 *
10.4 *	10.2 *	10.7 *	10.2 *	10.9 *

**beste Teiler: 7.2 (20.), 54.1 (18.), 125.3 (11.)**  
**Trefferlage: 0.10 mm rechts, 0.61 mm tief**  
**Streuwert: 1.10, horizontal: 1.30, vertikal: 0.86**

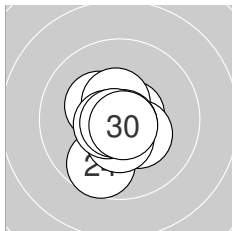

**Serie 3:**

10.7 *	10.3 *	10.3 *	9.7 ↘	10.5 *
10.5 *	10.6 *	10.8 *	10.8 *	10.8 *

**beste Teiler: 38.8 (28.), 43.8 (29.), 46.6 (30.)**  
**Trefferlage: 0.16 mm links, 0.41 mm tief**  
**Streuwert: 0.99, horizontal: 0.81, vertikal: 1.15**



Ergebnis: **290.3** (277)  
 Serien: 93.7 97.2 99.4  
 Zähler: 13 11 6 0 0 0 0 0 0  
 Innenzehner: 3  
 Weitester: 2381 (1.), 1986 (14.), 1748 (4.)  
 beste Teiler: 374.5 (18.), 418.0 (2.), 464.1 (30.)  
 Trefferlage: 1.28 mm rechts, 4.85 mm tief  
 Streuwert: 7.39, horizontal: 4.88, vertikal: 9.24

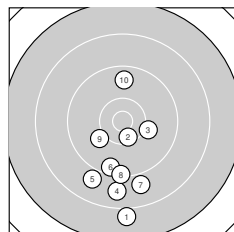
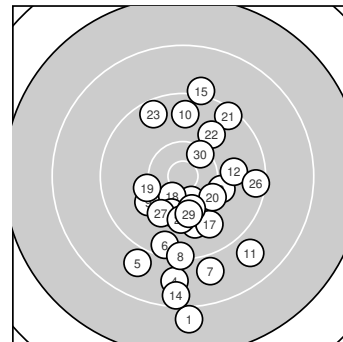

**Serie 1:**  
 8.0 ↓                      10.4 \*                      10.1 ↘                      8.8 ↓                      8.9 ↙  
 9.5 ↙                      8.9 ↓                      9.3 ↓                      10.1 ↖                      9.7 ↑  
 beste Teiler: 418.0 (2.), 674.8 (3.), 719.2 (9.)  
 Trefferlage: 0.44 mm links, 9.62 mm tief  
 Streuwert: 7.52, horizontal: 4.27, vertikal: 9.73

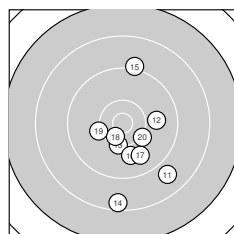

**Serie 2:**  
 8.8 ↘                      9.9 →                      10.3 ↓                      8.5 ↓                      9.1 ↑  
 9.9 ↓                      9.8 ↘                      10.5 \*                      10.2 ←                      10.2 ↘  
 beste Teiler: 374.5 (18.), 553.4 (13.), 604.6 (20.)  
 Trefferlage: 2.40 mm rechts, 4.78 mm tief  
 Streuwert: 7.27, horizontal: 5.14, vertikal: 8.90

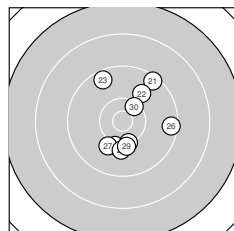

**Serie 3:**  
 9.4 ↗                      9.9 ↗                      9.5 ↖                      10.2 ↓                      10.3 ↓  
 9.4 →                      10.1 ↙                      10.0 ↓                      10.2 ↓                      10.4 \*  
 beste Teiler: 464.1 (30.), 555.5 (25.), 633.4 (24.)  
 Trefferlage: 1.88 mm rechts, 0.14 mm tief  
 Streuwert: 6.26, horizontal: 5.20, vertikal: 7.17



Ergebnis: **290.2** (275)  
 Serien: 92.3 97.6 100.3  
 Zähler: 13 11 5 0 1 0 0 0 0 0  
 Innenzehner: 4  
 Weitesten: 3601 (5.), 1805 (3.), 1765 (2.)  
 beste Teiler: 293.5 (9.), 354.7 (13.), 435.4 (23.)  
 Trefferlage: 1.54 mm links, 1.70 mm hoch  
 Streuwert: 8.53, horizontal: 8.76, vertikal: 8.29

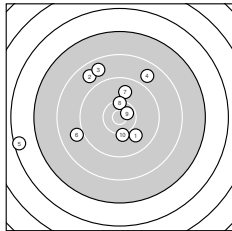
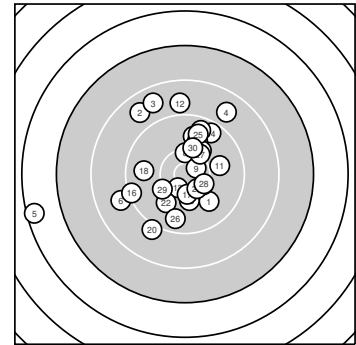

**Serie 1:**

9.9 ↘	8.7 ↘	8.7 ↗	8.8 ↗	6.4 ←
8.9 ←	9.8 ↑	10.3 ↑	10.6 *	10.2 ↓

beste Teiler: 293.5 (9.), 494.0 (8.), 620.6 (10.)  
 Trefferlage: 4.67 mm links, 3.26 mm hoch  
 Streuwert: 11.52, horizontal: 12.97, vertikal: 9.85

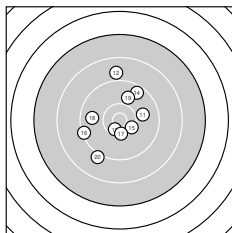

**Serie 2:**

9.9 →	8.9 ↑	10.5 *	9.5 ↗	10.3 ↘
9.3 ←	10.4 *	9.8 ←	9.9 ↑	9.1 ↙

beste Teiler: 354.7 (13.), 468.6 (17.), 488.2 (15.)  
 Trefferlage: 1.06 mm links, 0.91 mm hoch  
 Streuwert: 7.68, horizontal: 6.84, vertikal: 8.44

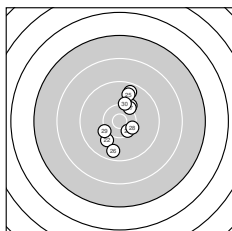

**Serie 3:**

10.1 ↗	10.0 ↙	10.4 *	9.6 ↗	9.7 ↗
9.6 ↓	10.2 ↗	10.3 ↘	10.2 ↙	10.2 ↑

beste Teiler: 435.4 (23.), 493.7 (28.), 578.4 (27.)  
 Trefferlage: 1.11 mm rechts, 0.95 mm hoch  
 Streuwert: 5.59, horizontal: 3.63, vertikal: 7.03



Ergebnis: **293.6** (281)  
 Serien: 100.9 99.2 93.5  
 Zähler: 16 10 3 1 0 0 0 0 0 0  
 Innenzehner: 7  
 Weitester: 3119 (29.), 2121 (27.), 1948 (24.)  
 beste Teiler: 118.6 (20.), 123.6 (1.), 172.6 (23.)  
 Trefferlage: 0.19 mm links, 5.24 mm hoch  
 Streuwert: 7.30, horizontal: 5.87, vertikal: 8.49

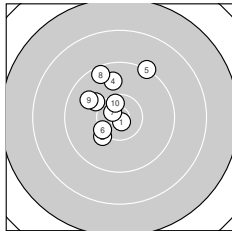
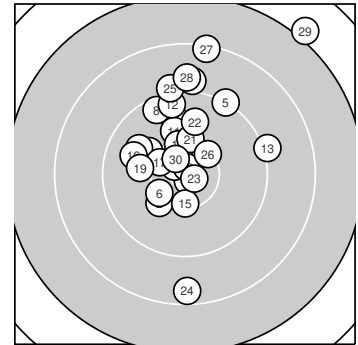

**Serie 1:**

10.8 *	10.1 ↙	10.1 ↘	9.8 ↑	9.2 ↗
10.3 ↙	10.7 *	9.5 ↘	9.9 ↘	10.5 *

beste Teiler: 123.6 (1.), 213.6 (7.), 367.9 (10.)  
 Trefferlage: 2.40 mm links, 3.55 mm hoch  
 Streuwert: 4.96, horizontal: 4.06, vertikal: 5.72

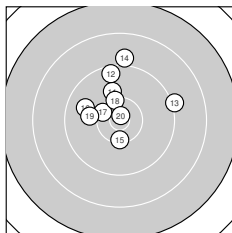

**Serie 2:**

10.0 ↑	9.5 ↑	9.1 →	9.0 ↑	10.3 ↓
9.8 ↖	10.4 *	10.3 ↑	10.0 ←	10.8 *

beste Teiler: 118.6 (20.), 465.2 (17.), 490.0 (15.)  
 Trefferlage: 1.00 mm links, 4.61 mm hoch  
 Streuwert: 5.95, horizontal: 6.12, vertikal: 5.78

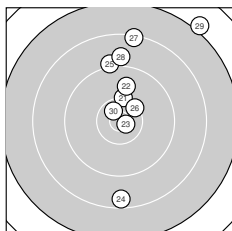

**Serie 3:**

10.2 ↑	9.8 ↑	10.7 *	8.5 ↓	9.1 ↑
10.3 ↗	8.3 ↑	8.9 ↑	7.1 ↗	10.6 *

beste Teiler: 172.6 (23.), 297.0 (30.), 507.4 (26.)  
 Trefferlage: 2.83 mm rechts, 7.55 mm hoch  
 Streuwert: 9.93, horizontal: 6.37, vertikal: 12.52



Ergebnis: **276.8** (262)  
 Serien: 93.4 92.1 91.3  
 Zähler: 4 17 7 1 1 0 0 0 0 0  
 Innenzehner: 1  
 Weitester: 3264 (7.), 2604 (26.), 2162 (20.)  
 beste Teiler: 265.8 (25.), 623.1 (1.), 710.1 (15.)  
 Trefferlage: 0.62 mm links, 0.08 mm hoch  
 Streuwert: 10.91, horizontal: 10.31, vertikal: 11.47

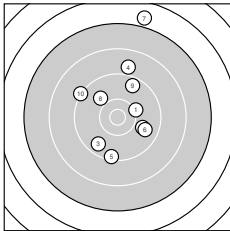
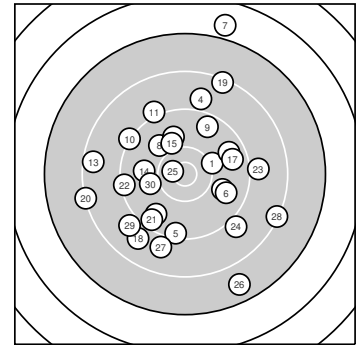

**Serie 1:**  
 10.2 →                      9.9 →                      9.6 ↙                      8.9 ↑                      9.4 ↓  
    9.8 →                      6.9 ↑                      9.9 ↘                      9.6 ↑                      9.2 ↘  
 beste Teiler: 623.1 (1.), 812.3 (8.), 857.5 (2.)  
 Trefferlage: 1.38 mm rechts, 4.52 mm hoch  
 Streuwert: 10.45, horizontal: 7.21, vertikal: 12.89

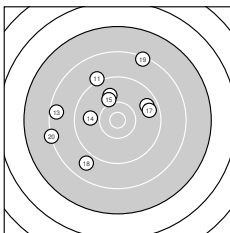

**Serie 2:**  
 9.1 ↘                      9.9 ↑                      8.5 ←                      9.9 ←                      10.1 ↘  
    9.7 →                      9.6 →                      8.8 ↙                      8.3 ↑                      8.2 ←  
 beste Teiler: 710.1 (15.), 823.6 (12.), 866.7 (14.)  
 Trefferlage: 4.34 mm links, 3.93 mm hoch  
 Streuwert: 10.17, horizontal: 11.11, vertikal: 9.13

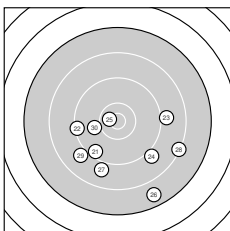

**Serie 3:**  
 9.5 ↙                      9.3 ←                      9.0 →                      9.0 ↘                      10.6 \*  
    7.7 ↘                      8.9 ↓                      8.3 →                      9.0 ↙                      10.0 ←  
 beste Teiler: 265.8 (25.), 761.5 (30.), 1192.5 (21.)  
 Trefferlage: 1.07 mm rechts, 8.19 mm tief  
 Streuwert: 10.10, horizontal: 12.01, vertikal: 7.73



Ergebnis: **282.9** (267)  
 Serien: 98.0 94.4 90.5  
 Zähler: 9 12 7 1 1 0 0 0 0 0  
 Innenzehner: 5  
 Weitesten: 3448 (26.), 2660 (22.), 2221 (13.)  
 beste Teiler: 209.7 (10.), 223.3 (25.), 232.3 (17.)  
 Trefferlage: 4.45 mm rechts, 0.81 mm tief  
 Streuwert: 9.72, horizontal: 8.01, vertikal: 11.17

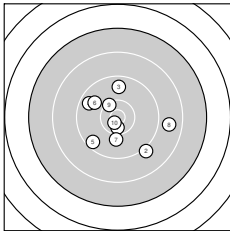
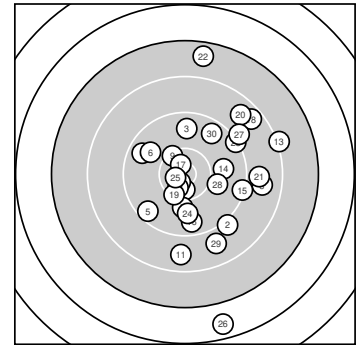

**Serie 1:**

10.5 *	9.1 ↘	9.7 ↑	9.6 ↖	9.5 ↙
9.8 ↖	10.0 ↓	8.8 →	10.3 ↗	10.7 *

beste Teiler: 209.7 (10.), 344.0 (1.), 495.0 (9.)  
 Trefferlage: 0.27 mm links, 1.08 mm tief  
 Streuwert: 7.60, horizontal: 8.26, vertikal: 6.88

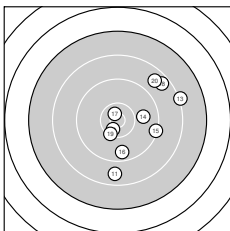

**Serie 2:**

8.7 ↓	10.5 *	8.2 →	9.9 →	9.3 →
9.6 ↓	10.7 *	8.5 ↗	10.3 ↘	8.7 ↗

beste Teiler: 232.3 (17.), 338.5 (12.), 517.1 (19.)  
 Trefferlage: 6.52 mm rechts, 0.36 mm tief  
 Streuwert: 9.12, horizontal: 8.42, vertikal: 9.78

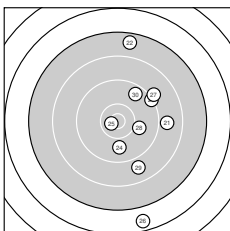

**Serie 3:**

8.9 →	7.6 ↑	9.3 ↗	9.9 ↓	10.7 *
6.6 ↓	9.1 ↗	10.0 →	8.8 ↘	9.6 ↗

beste Teiler: 223.3 (25.), 757.5 (28.), 877.0 (24.)  
 Trefferlage: 7.11 mm rechts, 0.98 mm tief  
 Streuwert: 12.02, horizontal: 5.49, vertikal: 16.09



Ergebnis: **278.0** (263)  
 Serien: 91.4 92.4 94.2  
 Zähler: 4 18 5 3 0 0 0 0 0 0  
 Innenzehner: 2  
 Weitester: 2900 (13.), 2588 (5.), 2468 (20.)  
 beste Teiler: 255.9 (17.), 438.9 (9.), 510.7 (19.)  
 Trefferlage: 1.28 mm rechts, 1.06 mm tief  
 Streuwert: 10.59, horizontal: 8.99, vertikal: 11.98

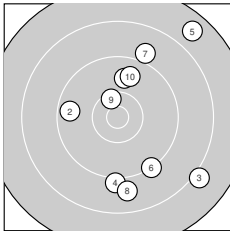
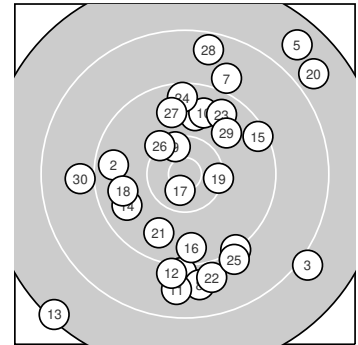

**Serie 1:**

9.8 ↑	9.6 ←	8.1 ↘	9.1 ↓	7.7 ↗
9.2 ↘	9.0 ↑	8.8 ↓	10.4 *	9.7 ↑

beste Teiler: 438.9 (9.), 895.9 (1.), 967.6 (10.)  
 Trefferlage: 4.32 mm rechts, 0.08 mm hoch  
 Streuwert: 11.24, horizontal: 8.67, vertikal: 13.31

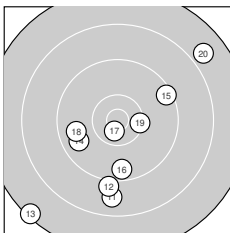

**Serie 2:**

8.8 ↓	9.1 ↓	7.3 ↙	9.7 ↙	9.4 ↗
9.6 ↓	10.6 *	9.7 ←	10.3 →	7.9 ↗

beste Teiler: 255.9 (17.), 510.7 (19.), 971.7 (18.)  
 Trefferlage: 0.54 mm links, 5.41 mm tief  
 Streuwert: 11.04, horizontal: 10.99, vertikal: 11.09

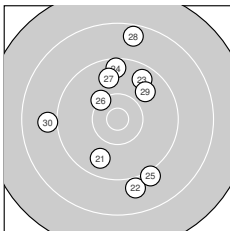

**Serie 3:**

9.7 ↙	8.9 ↓	9.6 ↗	9.5 ↑	9.1 ↘
10.2 ↘	9.8 ↑	8.6 ↑	9.8 ↗	9.0 ←

beste Teiler: 573.8 (26.), 883.8 (29.), 952.4 (27.)  
 Trefferlage: 0.08 mm rechts, 2.12 mm hoch  
 Streuwert: 9.42, horizontal: 6.99, vertikal: 11.34



Ergebnis: **272.0** (258)  
 Serien: 90.9 89.7 91.4  
 Zähler: 6 11 9 3 1 0 0 0 0 0  
 Innenzehner: 2  
 Weitesten: 3213 (16.), 3055 (3.), 2701 (7.)  
 beste Teiler: 209.3 (11.), 406.6 (19.), 521.4 (1.)  
 Trefferlage: 2.30 mm rechts, 3.31 mm hoch  
 Streuwert: 11.82, horizontal: 8.16, vertikal: 14.59

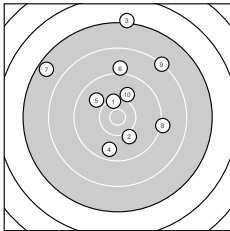
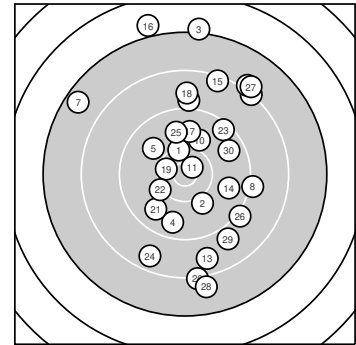

**Serie 1:**

10.3 ↑	10.1 ↘	7.1 ↑	9.6 ↓	9.9 ↖
9.0 ↑	7.6 ↗	9.1 →	8.2 ↗	10.0 ↑

beste Teiler: 521.4 (1.), 712.4 (2.), 775.1 (10.)  
 Trefferlage: 0.56 mm rechts, 7.64 mm hoch  
 Streuwert: 11.34, horizontal: 10.43, vertikal: 12.19

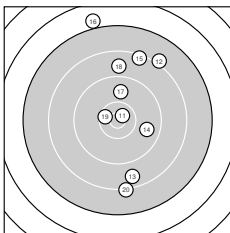

**Serie 2:**

10.7 *	8.1 ↗	8.7 ↓	9.7 →	8.4 ↑
6.9 ↑	9.8 ↑	8.8 ↑	10.4 *	8.2 ↓

beste Teiler: 209.3 (11.), 406.6 (19.), 900.4 (17.)  
 Trefferlage: 2.76 mm rechts, 5.53 mm hoch  
 Streuwert: 12.70, horizontal: 6.09, vertikal: 16.89

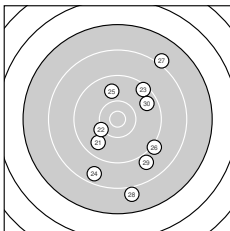

**Serie 3:**

9.8 ↖	10.2 ↖	9.4 ↗	8.6 ↓	9.8 ↑
9.1 ↘	8.1 ↗	7.9 ↓	8.9 ↘	9.6 →

beste Teiler: 614.2 (22.), 899.0 (25.), 955.6 (21.)  
 Trefferlage: 3.57 mm rechts, 3.23 mm tief  
 Streuwert: 10.98, horizontal: 7.97, vertikal: 13.33





# LP Auflage 30 – Wertung – Seniores I männl.

StandNr: 85

Nüse, Stephan #63

StartNr: 1022

7. Mai 2022 14:29

WF St. Michael Olsberg

Ergebnis: **294.0** (282)  
 Serien: 101.8 96.4 95.8  
 Zähler: 15 12 3 0 0 0 0 0 0 0  
 Innenzehner: 5  
 Weitester: 2290 (26.), 1966 (18.), 1796 (24.)  
 beste Teiler: 207.2 (2.), 218.4 (5.), 249.0 (8.)  
 Trefferlage: 2.82 mm rechts, 0.55 mm hoch  
 Streuwert: 7.25, horizontal: 3.74, vertikal: 9.55

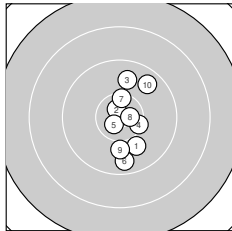
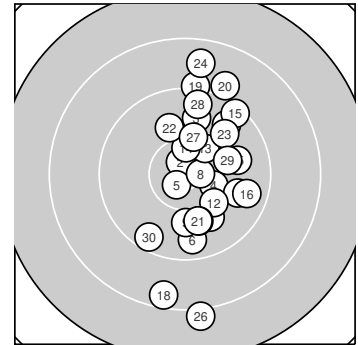

**Serie 1:**

10.0 ↘	10.7 *	9.8 ↑	10.3 →	10.7 *
9.6 ↓	10.4 *	10.6 *	10.0 ↓	9.7 ↗

beste Teiler: 207.2 (2.), 218.4 (5.), 249.0 (8.)  
 Trefferlage: 1.93 mm rechts, 0.51 mm tief  
 Streuwert: 4.99, horizontal: 2.54, vertikal: 6.58

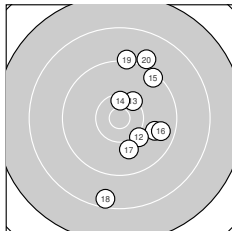

**Serie 2:**

9.8 →	10.1 ↘	10.3 ↗	10.4 *	9.4 ↗
9.7 →	10.0 ↓	8.5 ↓	9.2 ↑	9.0 ↑

beste Teiler: 422.3 (14.), 521.4 (13.), 651.2 (12.)  
 Trefferlage: 4.13 mm rechts, 0.87 mm hoch  
 Streuwert: 7.99, horizontal: 4.17, vertikal: 10.50

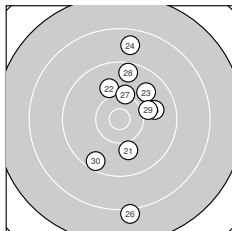

**Serie 3:**

10.0 ↓	10.0 ↖	9.8 ↗	8.7 ↑	9.9 →
8.1 ↓	10.2 ↑	9.5 ↑	10.1 →	9.5 ↙

beste Teiler: 608.3 (27.), 719.4 (29.), 777.6 (21.)  
 Trefferlage: 2.39 mm rechts, 1.29 mm hoch  
 Streuwert: 8.84, horizontal: 4.27, vertikal: 11.75



Ergebnis: **292.8** (279)  
 Serien: 95.9 100.6 96.3  
 Zähler: 14 11 5 0 0 0 0 0 0 0  
 Innenzehner: 8  
 Weitester: 2063 (26.), 2006 (2.), 1965 (7.)  
 beste Teiler: 71.8 (6.), 313.1 (23.), 336.7 (4.)  
 Trefferlage: 0.94 mm links, 1.15 mm hoch  
 Streuwert: 7.85, horizontal: 6.79, vertikal: 8.79

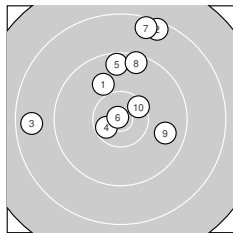
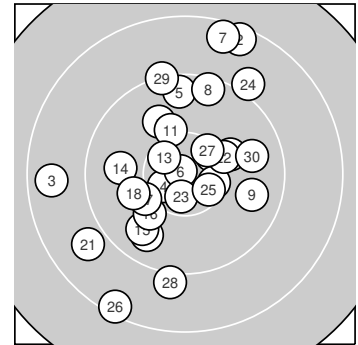

**Serie 1:**  
 9.9 ↘                      8.4 ↗                      8.7 ←  
 10.9 \*                      8.5 ↗                      9.4 ↗  
 beste Teiler: 71.8 (6.), 336.7 (4.), 450.2 (10.)  
 Trefferlage: 0.26 mm rechts, 6.54 mm hoch  
 Streuwert: 8.05, horizontal: 7.84, vertikal: 8.25

10.5 \*                      9.5 ↑  
 9.7 →                      10.4 \*

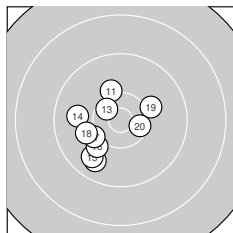

**Serie 2:**  
 10.2 ↘                      9.7 ↘                      10.5 \*  
 10.0 ↘                      10.1 ↘                      10.0 ←  
 beste Teiler: 366.3 (13.), 416.2 (20.), 638.8 (11.)  
 Trefferlage: 3.19 mm links, 1.66 mm tief  
 Streuwert: 4.77, horizontal: 4.83, vertikal: 4.71

9.8 ←                      9.8 ↘  
 10.1 →                      10.4 \*

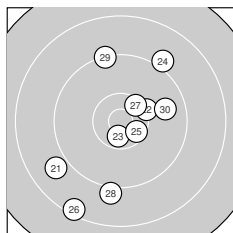

**Serie 3:**  
 8.9 ↘                      10.2 →                      10.6 \*  
 8.4 ↘                      10.4 \*                      9.1 ↓  
 beste Teiler: 313.1 (23.), 391.0 (25.), 451.3 (27.)  
 Trefferlage: 0.09 mm rechts, 1.42 mm tief  
 Streuwert: 9.10, horizontal: 7.42, vertikal: 10.51

9.1 ↗                      10.5 \*  
 9.3 ↑                      9.8 →



Ergebnis: **293.8** (279)  
 Serien: 100.4 97.1 96.3  
 Zähler: 12 15 3 0 0 0 0 0 0  
 Innenzehner: 3  
 Weitester: 2222 (30.), 1904 (18.), 1831 (11.)  
 beste Teiler: 350.3 (24.), 350.6 (10.), 370.6 (2.)  
 Trefferlage: 1.68 mm rechts, 1.68 mm hoch  
 Streuwert: 7.26, horizontal: 5.65, vertikal: 8.57

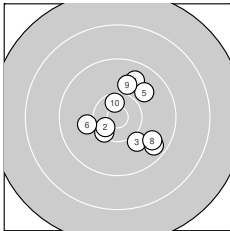
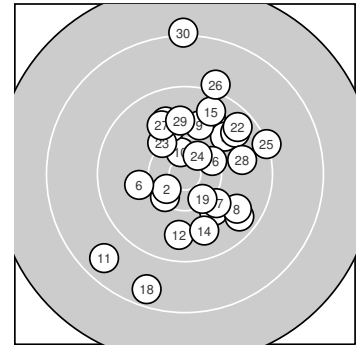

**Serie 1:**

10.4 ↙	10.5 *	10.0 ↘	9.8 ↗	9.9 ↗
10.0 ←	9.6 ↘	9.7 ↘	10.0 ↑	10.5 *

beste Teiler: 350.6 (10.), 370.6 (2.), 477.6 (1.)  
 Trefferlage: 1.99 mm rechts, 0.01 mm hoch  
 Streuwert: 5.58, horizontal: 5.29, vertikal: 5.85

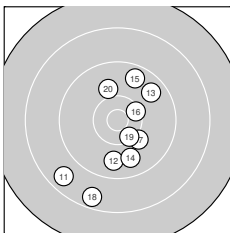

**Serie 2:**

8.7 ↙	9.8 ↓	9.7 ↗	9.8 ↓	9.6 ↗
10.4 →	10.1 ↘	8.6 ↓	10.4 ↘	10.0 ↑

beste Teiler: 476.3 (16.), 476.3 (19.), 672.2 (17.)  
 Trefferlage: 0.51 mm rechts, 3.23 mm tief  
 Streuwert: 7.95, horizontal: 6.14, vertikal: 9.43

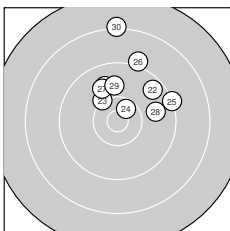

**Serie 3:**

9.9 ↖	9.6 ↗	10.2 ↘	10.5 *	9.2 →
9.1 ↗	9.9 ↖	9.8 →	9.9 ↑	8.2 ↑

beste Teiler: 350.3 (24.), 606.8 (23.), 844.4 (29.)  
 Trefferlage: 2.55 mm rechts, 8.27 mm hoch  
 Streuwert: 5.92, horizontal: 5.88, vertikal: 5.95



**Ergebnis:** **252.0** (240)  
**Serien:** 77.4 89.3 85.3  
**Zähler:** 5 8 10 3 2 1 0 0 0 0  
**Innenzehner:** 3  
**Weiteste:** 8962 (1.), 4039 (29.), 3918 (3.)  
**beste Teiler:** 275.4 (28.), 309.1 (14.), 473.1 (27.)  
**Trefferlage:** 0.36 mm links, 0.03 mm tief  
**Streuwert:** 18.85, horizontal: 21.49, vertikal: 15.76

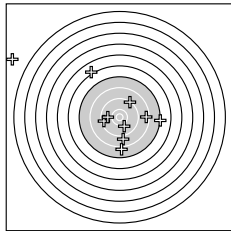
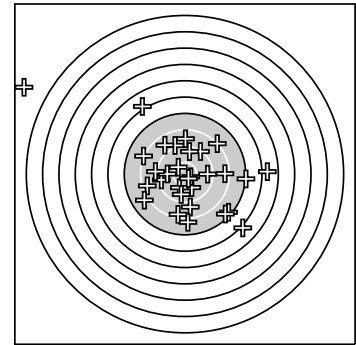

**Serie 1:**

0.0 ↘	7.2 →	6.1 ↖	8.9 ↓	8.5 →
9.5 ←	10.0 ↓	8.0 ↓	9.3 ↗	9.9 ←

**beste Teiler:** 739.7 (7.), 867.0 (10.), 1191.1 (6.)  
**Trefferlage:** 5.55 mm links, 3.56 mm hoch  
**Streuwert:** 25.49, horizontal: 29.65, vertikal: 20.50

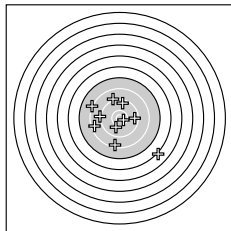

**Serie 2:**

9.1 ←	9.6 →	9.1 ↖	10.6 *	8.2 ↘
9.5 ↑	8.5 ↓	6.1 ↘	8.5 ←	10.1 ↓

**beste Teiler:** 309.1 (14.), 715.1 (20.), 1109.0 (12.)  
**Trefferlage:** 1.97 mm links, 2.45 mm tief  
**Streuwert:** 13.75, horizontal: 14.54, vertikal: 12.91

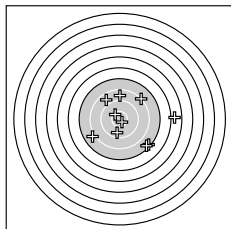

**Serie 3:**

8.8 ↑	8.2 ↗	8.8 ↖	9.7 ↓	7.4 ↘
7.5 ↘	10.4 *	10.6 *	5.9 →	8.0 ↖

**beste Teiler:** 275.4 (28.), 473.1 (27.), 1010.2 (24.)  
**Trefferlage:** 6.43 mm rechts, 1.20 mm tief  
**Streuwert:** 15.89, horizontal: 17.71, vertikal: 13.83



Ergebnis: **293.8** (280)  
 Serien: 97.6 99.2 97.0  
 Zähler: 14 13 2 1 0 0 0 0 0 0  
 Innenzehner: 6  
 Weitesten: 2425 (8.), 2344 (20.), 1729 (28.)  
 beste Teiler: 127.8 (17.), 215.9 (29.), 272.0 (14.)  
 Trefferlage: 0.13 mm links, 0.45 mm tief  
 Streuwert: 7.76, horizontal: 6.05, vertikal: 9.15

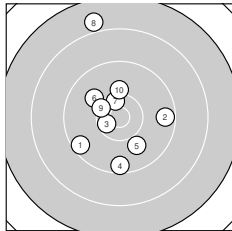
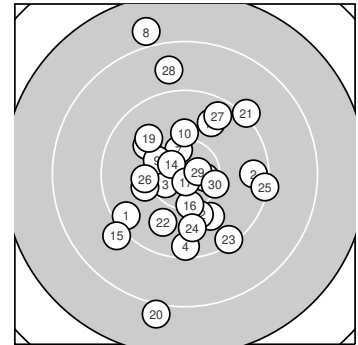

**Serie 1:**

9.5 ↙	9.5 →	10.5 *	9.5 ↓	9.9 ↘
10.0 ↘	10.4 *	7.9 ↑	10.3 ↖	10.1 ↑

beste Teiler: 356.4 (3.), 411.3 (7.), 509.3 (9.)  
 Trefferlage: 1.55 mm links, 1.40 mm hoch  
 Streuwert: 8.09, horizontal: 6.00, vertikal: 9.75

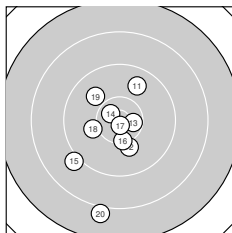

**Serie 2:**

9.8 ↗	10.1 ↓	10.5 *	10.6 *	9.1 ↙
10.3 ↓	10.8 *	10.1 ←	9.9 ↖	8.0 ↓

beste Teiler: 127.8 (17.), 272.0 (14.), 339.8 (13.)  
 Trefferlage: 1.96 mm links, 3.27 mm tief  
 Streuwert: 7.21, horizontal: 5.04, vertikal: 8.86

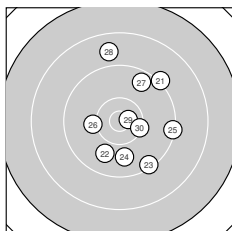

**Serie 3:**

9.2 ↗	9.9 ↙	9.3 ↘	9.8 ↓	9.3 →
10.1 ←	9.6 ↗	8.8 ↑	10.7 *	10.3 →

beste Teiler: 215.9 (29.), 520.5 (30.), 661.2 (26.)  
 Trefferlage: 3.11 mm rechts, 0.51 mm hoch  
 Streuwert: 7.79, horizontal: 6.24, vertikal: 9.09



Ergebnis: **286.2** (273)  
 Serien: 97.9 92.5 95.8  
 Zähler: 10 13 7 0 0 0 0 0 0 0  
 Innenzehner: 4  
 Weitesten: 2305 (9.), 2134 (21.), 1836 (25.)  
 beste Teiler: 151.1 (1.), 286.8 (28.), 325.8 (10.)  
 Trefferlage: 1.86 mm rechts, 0.24 mm tief  
 Streuwert: 8.92, horizontal: 5.41, vertikal: 11.41

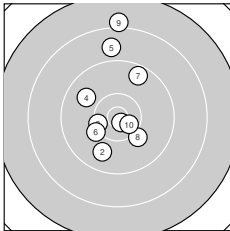
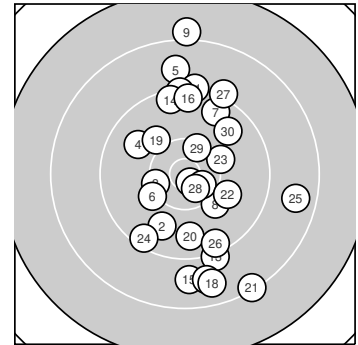

**Serie 1:**

10.8 *	9.8 ↙	10.3 ←	9.8 ↘	8.8 ↑
10.2 ↙	9.5 ↗	10.1 ↘	8.1 ↑	10.5 *

beste Teiler: 151.1 (1.), 325.8 (10.), 499.3 (3.)  
 Trefferlage: 0.90 mm links, 3.35 mm hoch  
 Streuwert: 7.88, horizontal: 4.39, vertikal: 10.25

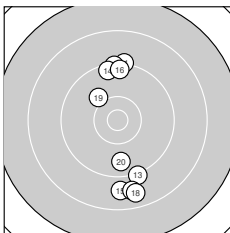

**Serie 2:**

9.2 ↑	9.3 ↑	9.2 ↓	9.4 ↑	8.8 ↓
9.4 ↑	8.8 ↓	8.7 ↓	10.0 ↘	9.7 ↓

beste Teiler: 721.7 (19.), 1007.2 (20.), 1230.6 (14.)  
 Trefferlage: 0.85 mm rechts, 1.80 mm tief  
 Streuwert: 10.33, horizontal: 2.98, vertikal: 14.30

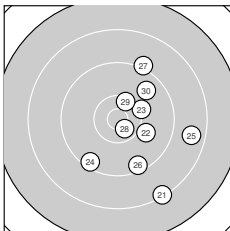

**Serie 3:**

8.3 ↓	10.0 ↘	10.2 →	9.4 ↙	8.7 →
9.4 ↓	9.1 ↗	10.6 *	10.4 *	9.7 ↗

beste Teiler: 286.8 (28.), 469.0 (29.), 626.3 (23.)  
 Trefferlage: 5.66 mm rechts, 2.28 mm tief  
 Streuwert: 8.01, horizontal: 6.35, vertikal: 9.38



Ergebnis: **292.1** (277)  
 Serien: 97.4 99.5 95.2  
 Zähler: 14 11 3 2 0 0 0 0 0 0  
 Innenzehner: 9  
 Weitesten: 2926 (25.), 2453 (14.), 2097 (3.)  
 beste Teiler: 61.0 (2.), 151.2 (29.), 263.5 (6.)  
 Trefferlage: 1.86 mm rechts, 0.44 mm hoch  
 Streuwert: 8.50, horizontal: 5.95, vertikal: 10.44

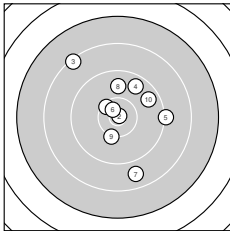
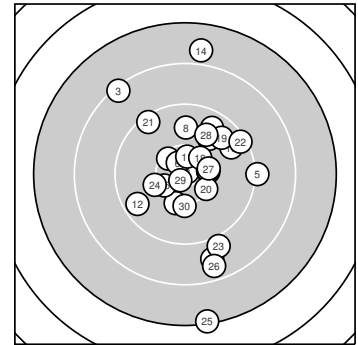

**Serie 1:**

10.4 *	10.9 *	8.3 ↘	9.6 ↗	9.2 →
10.6 *	8.8 ↓	9.8 ↑	10.2 ↓	9.6 ↗

beste Teiler: 61.0 (2.), 263.5 (6.), 450.0 (1.)  
 Trefferlage: 1.50 mm rechts, 2.31 mm hoch  
 Streuwert: 8.31, horizontal: 7.51, vertikal: 9.04

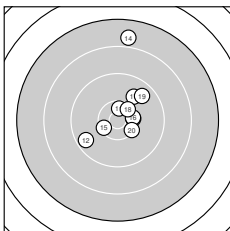

**Serie 2:**

10.5 *	9.6 ↙	10.4 *	7.9 ↑	10.4 *
10.4 *	9.9 ↗	10.4 *	9.7 ↗	10.3 ↘

beste Teiler: 347.7 (11.), 440.0 (18.), 458.6 (16.)  
 Trefferlage: 1.84 mm rechts, 3.53 mm hoch  
 Streuwert: 6.91, horizontal: 4.97, vertikal: 8.41

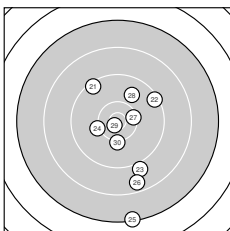

**Serie 3:**

9.4 ↘	9.4 ↗	9.0 ↓	10.2 ↙	7.3 ↓
8.6 ↓	10.4 →	9.9 ↗	10.8 *	10.2 ↓

beste Teiler: 151.2 (29.), 480.2 (27.), 625.0 (30.)  
 Trefferlage: 2.23 mm rechts, 4.52 mm tief  
 Streuwert: 9.73, horizontal: 5.70, vertikal: 12.52



# LP Auflage 30 – Wertung –Senioren II männl.

StandNr: 104

Schmidt, Wolfgang #508

StartNr: 1038

7. Mai 2022 14:31

3400 ABS Blomberg

Ergebnis: **300.4** (287)  
 Serien: 100.3 98.8 101.3  
 Zähler: 18 11 1 0 0 0 0 0 0  
 Innenzehner: 7  
 Weitester: 1899 (16.), 1436 (7.), 1287 (5.)  
 beste Teiler: 95.6 (29.), 223.0 (10.), 275.9 (28.)  
 Trefferlage: 2.70 mm links, 0.86 mm hoch  
 Streuwert: 5.69, horizontal: 3.72, vertikal: 7.13

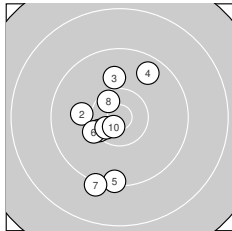
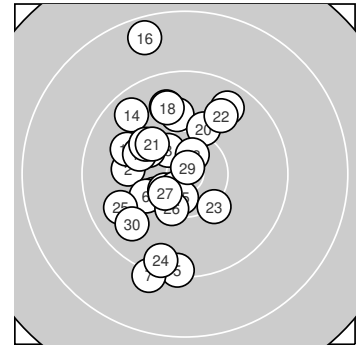

**Serie 1:**  
 10.3 ↙                      10.0 ←                      10.0 ↑                      9.6 ↗                      9.3 ↓  
 10.2 ↙                      9.2 ↓                      10.5 \*                      10.5 \*                      10.7 \*  
 beste Teiler: 223.0 (10.), 343.4 (9.), 388.9 (8.)  
 Trefferlage: 2.42 mm links, 1.53 mm tief  
 Streuwert: 5.84, horizontal: 3.55, vertikal: 7.45

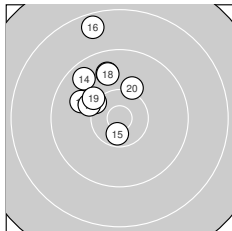

**Serie 2:**  
 9.8 ↑                      9.9 ↖                      10.2 ↖                      9.6 ↖                      10.6 \*  
 8.6 ↑                      10.1 ↖                      9.8 ↑                      10.1 ↖                      10.1 ↗  
 beste Teiler: 315.3 (15.), 580.8 (13.), 654.2 (20.)  
 Trefferlage: 3.92 mm links, 6.00 mm hoch  
 Streuwert: 4.57, horizontal: 3.19, vertikal: 5.61

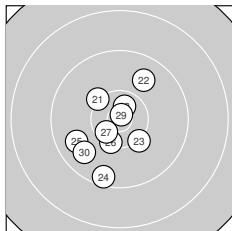

**Serie 3:**  
 10.2 ↖                      9.8 ↗                      10.2 ↘                      9.5 ↓                      9.7 ↙  
 10.3 ↓                      10.5 \*                      10.6 \*                      10.8 \*                      9.7 ↙  
 beste Teiler: 95.6 (29.), 275.9 (28.), 368.4 (27.)  
 Trefferlage: 1.76 mm links, 1.88 mm tief  
 Streuwert: 5.08, horizontal: 4.37, vertikal: 5.70





**Ergebnis: 283.0 (269)**  
**Serien: 95.0 93.0 95.0**  
**Zähler: 9 14 4 3 0 0 0 0 0 0**  
**Innenzehner: 4**  
**Weiteste: 3176 (13.), 2848 (9.), 2775 (12.)**  
**beste Teiler: 118.2 (25.), 255.7 (2.), 300.3 (15.)**  
**Trefferlage: 4.21 mm rechts, 0.03 mm hoch**  
**Streuwert: 9.77, horizontal: 7.01, vertikal: 11.91**

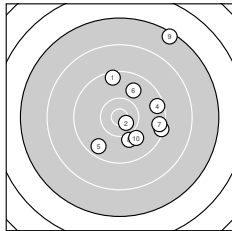
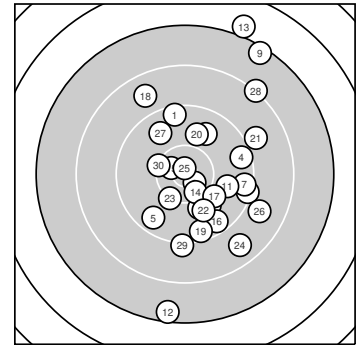

**Serie 1:**

9.4 ↑	10.6 *	9.3 →	9.5 →	9.6 ↙
9.8 ↗	9.4 →	10.0 ↓	7.4 ↗	10.0 ↘

**beste Teiler: 255.7 (2.), 734.5 (8.), 794.7 (10.)**  
**Trefferlage: 5.62 mm rechts, 1.84 mm hoch**  
**Streuwert: 8.76, horizontal: 6.94, vertikal: 10.27**

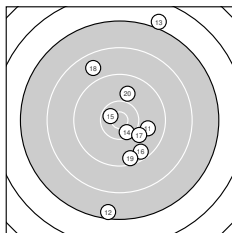

**Serie 2:**

9.8 →	7.5 ↓	7.0 ↑	10.4 *	10.6 *
9.5 ↘	10.0 ↘	8.8 ↖	9.5 ↓	9.9 ↑

**beste Teiler: 300.3 (15.), 416.0 (14.), 734.6 (17.)**  
**Trefferlage: 2.59 mm rechts, 0.44 mm tief**  
**Streuwert: 11.82, horizontal: 5.96, vertikal: 15.61**

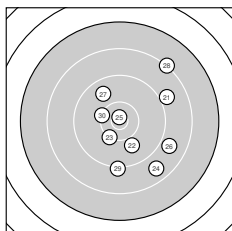

**Serie 3:**

9.0 →	9.9 ↓	10.2 ↙	8.7 ↘	10.8 *
8.9 ↘	9.8 ↖	8.2 ↗	9.2 ↓	10.3 ↖

**beste Teiler: 118.2 (25.), 555.6 (30.), 568.2 (23.)**  
**Trefferlage: 4.41 mm rechts, 1.28 mm tief**  
**Streuwert: 9.27, horizontal: 8.34, vertikal: 10.11**



Ergebnis: **289.4** (275)  
 Serien: 97.7 96.1 95.6  
 Zähler: 9 17 4 0 0 0 0 0 0 0  
 Innenzehner: 5  
 Weitestе: 2029 (12.), 1882 (5.), 1760 (11.)  
 beste Teiler: 254.0 (7.), 317.4 (19.), 367.9 (16.)  
 Trefferlage: 1.07 mm rechts, 0.98 mm hoch  
 Streuwert: 8.15, horizontal: 7.23, vertikal: 8.97

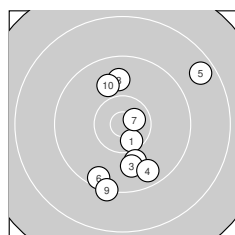
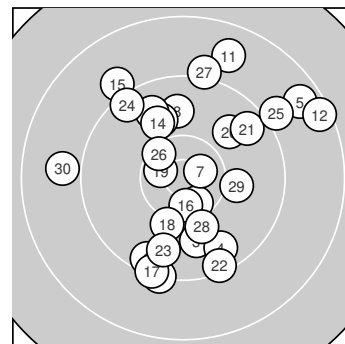

**Serie 1:**  
 10.5 \*                      10.0 ↓                      9.9 ↓                      9.6 ↓                      8.6 ↗  
 9.5 ↓                      10.6 \*                      9.8 ↑                      9.3 ↓                      9.9 ↖  
 beste Teiler: 254.0 (7.), 378.1 (1.), 780.8 (2.)  
 Trefferlage: 1.76 mm rechts, 2.44 mm tief  
 Streuwert: 7.49, horizontal: 5.82, vertikal: 8.86

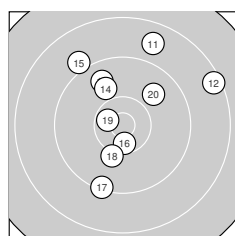

**Serie 2:**  
 8.8 ↗                      8.4 ↗                      9.7 ↖                      9.9 ↖                      9.0 ↖  
 10.5 \*                      9.3 ↓                      10.1 ↓                      10.6 \*                      9.8 ↗  
 beste Teiler: 317.4 (19.), 367.9 (16.), 655.8 (18.)  
 Trefferlage: 0.54 mm rechts, 3.88 mm hoch  
 Streuwert: 8.46, horizontal: 7.82, vertikal: 9.05

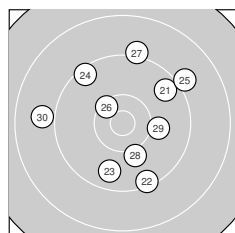

**Serie 3:**  
 9.6 ↗                      9.4 ↓                      9.7 ↓                      9.4 ↖                      9.0 ↗  
 10.4 \*                      9.1 ↑                      10.1 ↓                      10.0 →                      8.9 ←  
 beste Teiler: 461.0 (26.), 701.9 (28.), 730.0 (29.)  
 Trefferlage: 0.91 mm rechts, 1.51 mm hoch  
 Streuwert: 8.63, horizontal: 8.52, vertikal: 8.73



Ergebnis: **288.0** (277)  
 Serien: 98.1 92.9 97.0  
 Zähler: 13 12 4 1 0 0 0 0 0 0  
 Innenzehner: 5  
 Weitester: 2482 (17.), 2071 (10.), 1878 (12.)  
 beste Teiler: 238.4 (20.), 377.9 (6.), 412.9 (3.)  
 Trefferlage: 1.91 mm links, 2.39 mm tief  
 Streuwert: 8.50, horizontal: 7.01, vertikal: 9.76

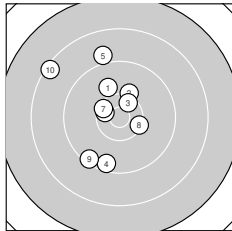
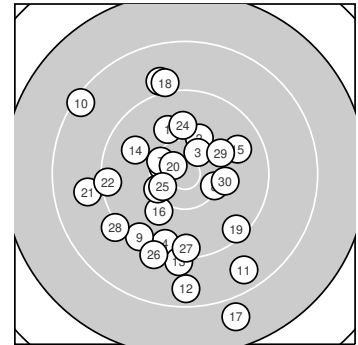

**Serie 1:**

10.0 ↖	10.2 ↗	10.4 *	9.5 ↓	9.0 ↑
10.5 *	10.4 *	10.3 ↘	9.4 ↙	8.4 ↖

beste Teiler: 377.9 (6.), 412.9 (3.), 451.4 (7.)  
 Trefferlage: 3.30 mm links, 2.34 mm hoch  
 Streuwert: 7.43, horizontal: 6.11, vertikal: 8.56

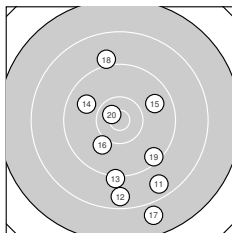

**Serie 2:**

8.6 ↘	8.6 ↓	9.2 ↓	9.8 ↖	9.8 ↗
10.0 ↙	7.8 ↘	9.0 ↑	9.4 ↘	10.7 *

beste Teiler: 238.4 (20.), 742.1 (16.), 903.8 (14.)  
 Trefferlage: 1.66 mm rechts, 6.28 mm tief  
 Streuwert: 9.76, horizontal: 6.50, vertikal: 12.17

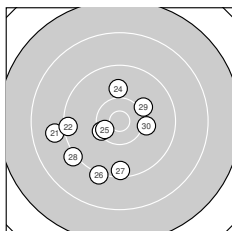

**Serie 3:**

8.9 ←	9.4 ←	10.3 ↙	10.0 ↑	10.4 *
9.2 ↓	9.4 ↓	9.2 ↙	10.1 ↗	10.1 →

beste Teiler: 419.0 (25.), 508.7 (23.), 668.7 (30.)  
 Trefferlage: 4.10 mm links, 3.24 mm tief  
 Streuwert: 7.09, horizontal: 7.56, vertikal: 6.58



Ergebnis: **286.4** (272)  
 Serien: 91.9 96.4 98.1  
 Zähler: 12 12 3 2 1 0 0 0 0 0  
 Innenzehner: 4  
 Weitesten: 3594 (9.), 2897 (10.), 2484 (4.)  
 beste Teiler: 128.1 (15.), 420.6 (21.), 421.0 (25.)  
 Trefferlage: 0.67 mm rechts, 4.16 mm tief  
 Streuwert: 9.20, horizontal: 9.79, vertikal: 8.57

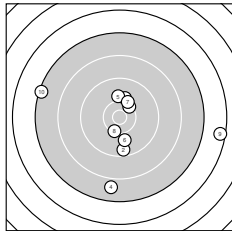
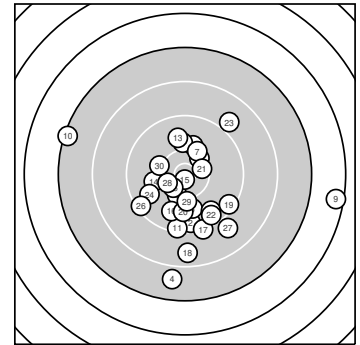

**Serie 1:**

10.3 ↗	9.5 ↓	10.1 ↑	7.8 ↓	10.0 ↑
9.9 ↓	10.2 ↗	10.3 ↓	6.5 →	7.3 ←

beste Teiler: 502.4 (1.), 523.0 (8.), 611.5 (7.)  
 Trefferlage: 1.38 mm rechts, 2.26 mm tief  
 Streuwert: 13.07, horizontal: 15.05, vertikal: 10.72

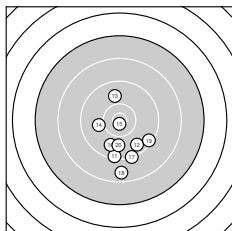

**Serie 2:**

9.3 ↓	9.6 ↘	9.9 ↑	10.0 ←	10.8 *
9.8 ↓	9.2 ↓	8.6 ↓	9.4 ↘	9.8 ↓

beste Teiler: 128.1 (15.), 752.9 (14.), 869.1 (13.)  
 Trefferlage: 0.68 mm rechts, 7.18 mm tief  
 Streuwert: 6.40, horizontal: 5.03, vertikal: 7.53

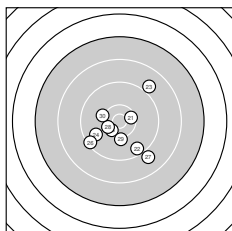

**Serie 3:**

10.4 *	9.5 ↘	8.9 ↗	9.8 ←	10.4 *
9.4 ↗	8.9 ↘	10.4 *	10.2 ↓	10.2 ←

beste Teiler: 420.6 (21.), 421.0 (25.), 457.0 (28.)  
 Trefferlage: 0.03 mm links, 3.05 mm tief  
 Streuwert: 7.26, horizontal: 7.46, vertikal: 7.05



Ergebnis: **302.0** (291)  
 Serien: 102.9 102.5 96.6  
 Zähler: 22 7 1 0 0 0 0 0 0  
 Innenzehner: 11  
 Weitester: 2246 (26.), 1450 (22.), 1311 (29.)  
 beste Teiler: 58.5 (7.), 104.3 (11.), 257.9 (10.)  
 Trefferlage: 0.75 mm rechts, 3.01 mm hoch  
 Streuwert: 5.53, horizontal: 3.17, vertikal: 7.15

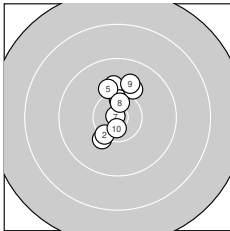
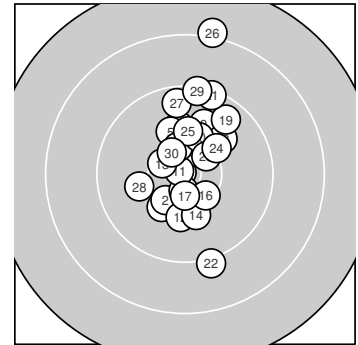

**Serie 1:**

10.2 ↘	10.3 ↘	10.0 ↑	10.4 *	10.1 ↑
10.0 ↗	10.9 *	10.5 *	9.9 ↗	10.6 *

beste Teiler: 58.5 (7.), 257.9 (10.), 345.0 (8.)  
 Trefferlage: 0.32 mm links, 2.45 mm hoch  
 Streuwert: 3.89, horizontal: 2.36, vertikal: 4.97

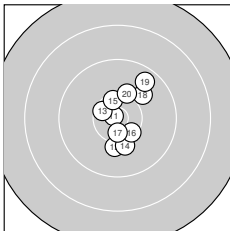

**Serie 2:**

10.8 *	10.1 ↓	10.5 *	10.1 ↓	10.4 *
10.4 *	10.5 *	9.9 ↗	9.6 ↗	10.2 ↑

beste Teiler: 104.3 (11.), 336.0 (17.), 393.1 (13.)  
 Trefferlage: 1.31 mm rechts, 0.64 mm hoch  
 Streuwert: 4.43, horizontal: 3.19, vertikal: 5.39

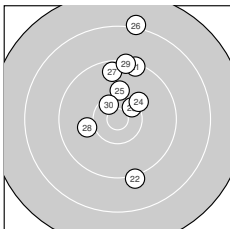

**Serie 3:**

9.3 ↑	9.1 ↓	10.4 *	10.2 ↗	10.1 ↑
8.1 ↑	9.6 ↑	10.0 ←	9.3 ↑	10.5 *

beste Teiler: 396.6 (30.), 433.7 (23.), 638.7 (24.)  
 Trefferlage: 1.27 mm rechts, 5.95 mm hoch  
 Streuwert: 7.40, horizontal: 3.84, vertikal: 9.74



Ergebnis: **297.2** (281)  
 Serien: 101.4 97.9 97.9  
 Zähler: 13 15 2 0 0 0 0 0 0 0  
 Innenzehner: 5  
 Weitester: 1759 (27.), 1618 (14.), 1460 (23.)  
 beste Teiler: 283.8 (6.), 308.3 (12.), 372.8 (25.)  
 Trefferlage: 0.66 mm rechts, 2.56 mm tief  
 Streuwert: 6.37, horizontal: 7.39, vertikal: 5.16

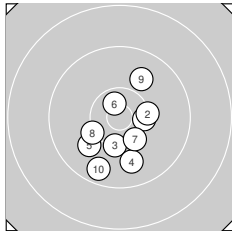
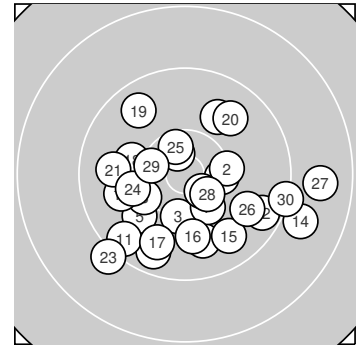

**Serie 1:**  
 10.4 →                      10.3 →                      10.3 ↓                      9.8 ↓                      10.0 ↙  
 10.6 \*                      10.3 ↘                      10.2 ↖                      9.9 ↗                      9.6 ↓  
 beste Teiler: 283.8 (6.), 478.5 (1.), 520.9 (7.)  
 Trefferlage: 0.25 mm rechts, 2.63 mm tief  
 Streuwert: 4.83, horizontal: 4.28, vertikal: 5.32

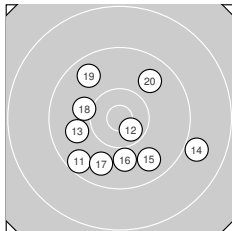

**Serie 2:**  
 9.5 ↖                      10.6 \*                      9.9 ←                      8.9 →                      9.7 ↘  
 9.9 ↓                      9.8 ↓                      10.1 ←                      9.7 ↖                      9.8 ↗  
 beste Teiler: 308.3 (12.), 712.1 (18.), 813.2 (16.)  
 Trefferlage: 0.28 mm links, 2.68 mm tief  
 Streuwert: 7.08, horizontal: 7.63, vertikal: 6.48

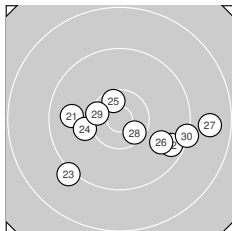

**Serie 3:**  
 9.8 ←                      9.6 →                      9.1 ↖                      10.1 ←                      10.5 \*  
 9.8 ↘                      8.8 →                      10.5 \*                      10.4 \*                      9.3 →  
 beste Teiler: 372.8 (25.), 388.8 (28.), 448.6 (29.)  
 Trefferlage: 2.01 mm rechts, 2.38 mm tief  
 Streuwert: 7.47, horizontal: 9.80, vertikal: 3.93



# LP Auflage 30 – Wertung ~~Senioren III männl.~~

StandNr: 98

Nentwig, Peter #410

StartNr: 1100

7. Mai 2022 14:14

3100 SGes Heepen e.V.

Ergebnis: **291.4** (276)  
 Serien: 98.7 94.6 98.1  
 Zähler: 12 12 6 0 0 0 0 0 0  
 Innenzehner: 9  
 Weitester: 2108 (25.), 2011 (15.), 1940 (10.)  
 beste Teiler: 221.2 (29.), 223.0 (27.), 239.4 (1.)  
 Trefferlage: 0.49 mm rechts, 6.07 mm tief  
 Streuwert: 7.10, horizontal: 5.35, vertikal: 8.49

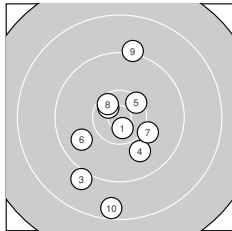
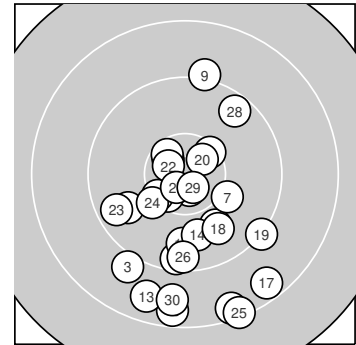

**Serie 1:**

10.7 *	10.6 *	9.0 ↙	9.9 ↘	10.4 *
9.8 ↙	10.1 ↘	10.5 *	9.2 ↑	8.5 ↓

beste Teiler: 239.4 (1.), 314.2 (2.), 375.9 (8.)  
 Trefferlage: 0.55 mm links, 2.79 mm tief  
 Streuwert: 7.45, horizontal: 4.93, vertikal: 9.30

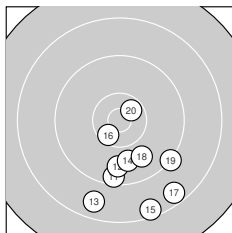

**Serie 2:**

9.4 ↓	9.7 ↓	8.7 ↓	9.9 ↓	8.4 ↘
10.5 *	8.5 ↘	9.8 ↘	9.2 ↘	10.5 *

beste Teiler: 323.4 (20.), 395.6 (16.), 879.9 (14.)  
 Trefferlage: 2.84 mm rechts, 9.94 mm tief  
 Streuwert: 6.03, horizontal: 5.61, vertikal: 6.42

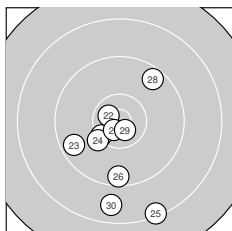

**Serie 3:**

10.3 ↙	10.6 *	9.6 ↙	10.2 ↙	8.3 ↘
9.5 ↓	10.7 *	9.5 ↗	10.7 *	8.7 ↓

beste Teiler: 221.2 (29.), 223.0 (27.), 262.9 (22.)  
 Trefferlage: 0.78 mm links, 5.49 mm tief  
 Streuwert: 7.16, horizontal: 5.22, vertikal: 8.68



**Ergebnis: 283.0 (265)**  
**Serien: 92.6 91.6 98.8**  
**Zähler: 8 12 7 3 0 0 0 0 0 0**  
**Innenzehner: 7**  
**Weiteste: 3147 (3.), 2884 (14.), 2681 (18.)**  
**beste Teiler: 233.3 (24.), 288.5 (15.), 339.4 (17.)**  
**Trefferlage: 0.42 mm links, 1.56 mm hoch**  
**Streuwert: 10.35, horizontal: 7.63, vertikal: 12.50**

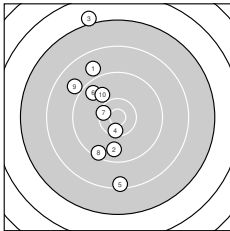
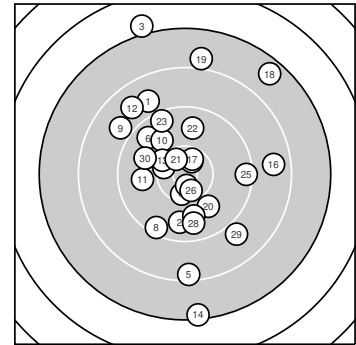

**Serie 1:**  
 8.9 ↘                      9.7 ↓                      7.0 ↑                      10.4 \*                      8.4 ↓  
 9.6 ↘                      10.4 \*                      9.4 ↗                      8.9 ↘                      9.9 ↘  
**beste Teiler: 413.4 (4.), 453.2 (7.), 832.9 (10.)**  
**Trefferlage: 5.28 mm links, 2.50 mm hoch**  
**Streuwert: 10.75, horizontal: 4.23, vertikal: 14.60**

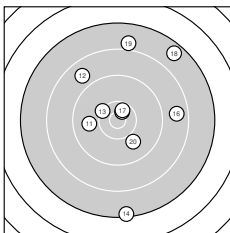

**Serie 2:**  
 9.9 ←                      8.8 ↘                      10.3 ↘                      7.3 ↓                      10.6 \*  
 8.7 →                      10.5 \*                      7.6 ↗                      8.0 ↑                      9.9 ↘  
**beste Teiler: 288.5 (15.), 339.4 (17.), 540.0 (13.)**  
**Trefferlage: 2.49 mm rechts, 3.17 mm hoch**  
**Streuwert: 12.43, horizontal: 9.56, vertikal: 14.74**

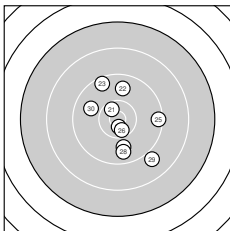

**Serie 3:**  
 10.5 \*                      9.8 ↑                      9.5 ↘                      10.7 \*                      9.4 →  
 10.5 \*                      9.9 ↓                      9.7 ↓                      8.9 ↘                      9.9 ↘  
**beste Teiler: 233.3 (24.), 351.0 (21.), 355.1 (26.)**  
**Trefferlage: 1.51 mm rechts, 0.98 mm tief**  
**Streuwert: 7.08, horizontal: 6.21, vertikal: 7.86**





**Ergebnis: 255.9 (244)**  
**Serien: 82.7 88.5 84.7**  
**Zähler: 4 5 13 7 1 0 0 0 0 0**  
**Innenzehner: 3**  
**Weiteste: 3281 (27.), 3102 (12.), 3073 (5.)**  
**beste Teiler: 436.6 (19.), 443.8 (30.), 466.5 (11.)**  
**Trefferlage: 6.81 mm links, 2.42 mm hoch**  
**Streuwert: 14.15, horizontal: 9.80, vertikal: 17.44**

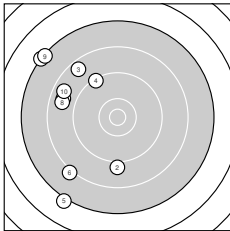
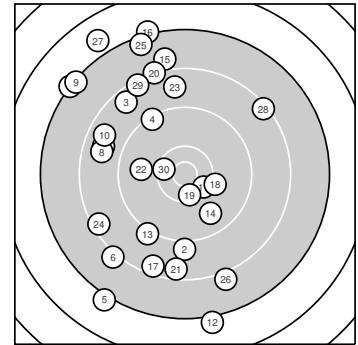

**Serie 1:**

7.2 ↘	9.0 ↓	8.6 ↖	9.3 ↖	7.1 ↙
8.1 ↗	8.7 ←	8.7 ←	7.3 ↘	8.7 ↖

**beste Teiler: 1312.4 (4.), 1547.0 (2.), 1771.8 (7.)**  
**Trefferlage: 14.68 mm links, 2.31 mm hoch**  
**Streuwert: 12.34, horizontal: 7.00, vertikal: 15.98**

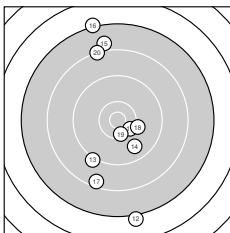

**Serie 2:**

10.4 *	7.1 ↓	9.1 ↗	9.7 ↘	7.9 ↑
7.2 ↑	8.4 ↘	10.1 →	10.4 *	8.2 ↑

**beste Teiler: 436.6 (19.), 466.5 (11.), 656.1 (18.)**  
**Trefferlage: 1.05 mm links, 0.49 mm tief**  
**Streuwert: 14.35, horizontal: 5.98, vertikal: 19.39**

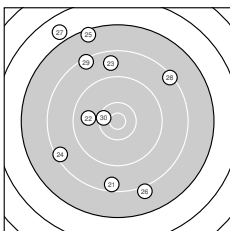

**Serie 3:**

8.5 ↓	9.8 ←	8.7 ↑	8.4 ↖	7.4 ↑
8.0 ↓	6.8 ↖	8.3 ↗	8.4 ↖	10.4 *

**beste Teiler: 443.8 (30.), 905.3 (22.), 1806.2 (23.)**  
**Trefferlage: 4.71 mm links, 5.44 mm hoch**  
**Streuwert: 14.90, horizontal: 10.69, vertikal: 18.16**



# LP Auflage 30 – Wertung ~~Senioren III männl.~~

StandNr: 86

Nüse, Reinhold #62

StartNr: 1112

7. Mai 2022 14:34

WF St. Michael Olsberg

Ergebnis: **299.5** (286)  
 Serien: 101.6 102.3 95.6  
 Zähler: 19 8 3 0 0 0 0 0 0  
 Innenzehner: 10  
 Weitesten: 2192 (22.), 1855 (27.), 1620 (29.)  
 beste Teiler: 174.6 (20.), 217.8 (25.), 239.3 (21.)  
 Trefferlage: 1.95 mm rechts, 3.54 mm hoch  
 Streuwert: 5.89, horizontal: 4.61, vertikal: 6.93

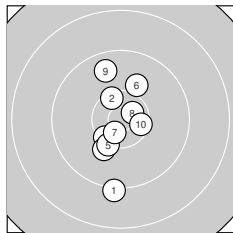
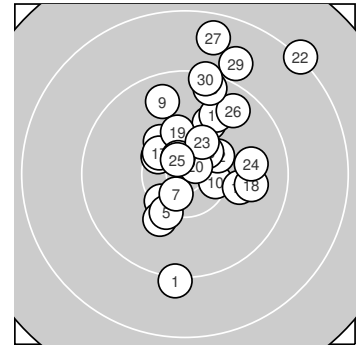

**Serie 1:**  
 9.2 ↓                      10.4 \*                      10.4 ↙                      10.1 ↘                      10.2 ↘  
 10.0 ↗                      10.6 \*                      10.6 \*                      9.7 ↗                      10.4 \*  
 beste Teiler: 270.7 (8.), 289.1 (7.), 418.3 (10.)  
 Trefferlage: 0.66 mm links, 1.05 mm tief  
 Streuwert: 5.29, horizontal: 2.81, vertikal: 6.94

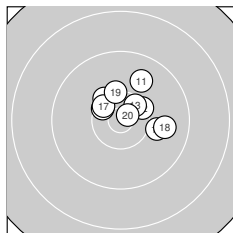

**Serie 2:**  
 9.8 ↗                      10.3 ↗                      10.4 \*                      10.4 \*                      10.3 ↘  
 10.0 →                      10.4 \*                      9.8 →                      10.2 ↑                      10.7 \*  
 beste Teiler: 174.6 (20.), 415.8 (13.), 426.8 (14.)  
 Trefferlage: 1.75 mm rechts, 2.62 mm hoch  
 Streuwert: 3.80, horizontal: 4.50, vertikal: 2.93

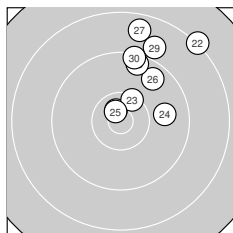

**Serie 3:**  
 10.7 \*                      8.2 ↗                      10.3 ↗                      9.8 →                      10.7 \*  
 9.6 ↗                      8.6 ↑                      9.5 ↑                      8.9 ↗                      9.3 ↑  
 beste Teiler: 217.8 (25.), 239.3 (21.), 482.7 (23.)  
 Trefferlage: 4.76 mm rechts, 9.08 mm hoch  
 Streuwert: 5.64, horizontal: 4.89, vertikal: 6.30



Ergebnis: **296.2** (282)  
 Serien: 98.3 93.6 104.3  
 Zähler: 19 7 2 1 1 0 0 0 0  
 Innenzehner: 11  
 Weitesten: 3549 (2.), 2610 (16.), 1950 (13.)  
 beste Teiler: 110.3 (27.), 195.5 (10.), 238.1 (29.)  
 Trefferlage: 0.95 mm rechts, 1.78 mm tief  
 Streuwert: 8.03, horizontal: 7.92, vertikal: 8.14

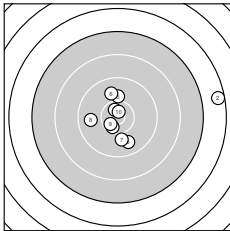
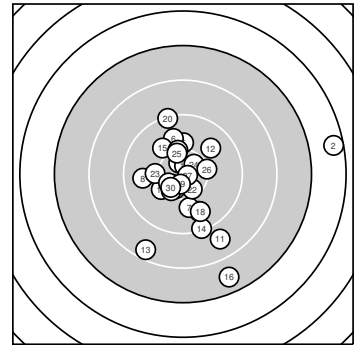

**Serie 1:**  
 10.6 \*                      6.5 →                      9.8 ↓                      10.5 \*                      10.0 ↑  
 9.9 ↑                      10.0 ↓                      9.8 ←                      10.5 \*                      10.7 \*  
 beste Teiler: 195.5 (10.), 275.9 (1.), 340.2 (9.)  
 Trefferlage: 2.37 mm rechts, 0.36 mm hoch  
 Streuwert: 9.44, horizontal: 11.91, vertikal: 6.02

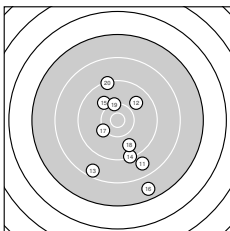

**Serie 2:**  
 8.8 ↓                      9.8 ↗                      8.5 ↙                      9.3 ↓                      10.0 ↘  
 7.7 ↓                      10.2 ↖                      9.8 ↓                      10.2 ↑                      9.3 ↑  
 beste Teiler: 565.2 (19.), 614.8 (17.), 767.1 (15.)  
 Trefferlage: 1.09 mm rechts, 5.06 mm tief  
 Streuwert: 9.85, horizontal: 6.57, vertikal: 12.29

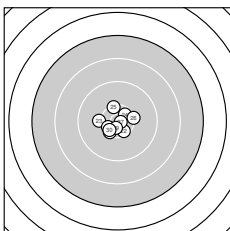

**Serie 3:**  
 10.4 \*                      10.4 \*                      10.1 ←                      10.5 \*                      10.3 ↑  
 10.2 →                      10.8 \*                      10.5 \*                      10.7 \*                      10.4 \*  
 beste Teiler: 110.3 (27.), 238.1 (29.), 343.3 (24.)  
 Trefferlage: 0.60 mm links, 0.64 mm tief  
 Streuwert: 3.17, horizontal: 3.49, vertikal: 2.82



Ergebnis: **271.6** (257)  
 Serien: 91.6 92.8 87.2  
 Zähler: 8 10 8 2 0 1 1 0 0 0  
 Innenzehner: 4  
 Weitestе: 4948 (9.), 4057 (20.), 2770 (26.)  
 beste Teiler: 335.0 (4.), 341.2 (2.), 349.7 (18.)  
 Trefferlage: 0.28 mm rechts, 3.92 mm tief  
 Streuwert: 12.99, horizontal: 11.29, vertikal: 14.49

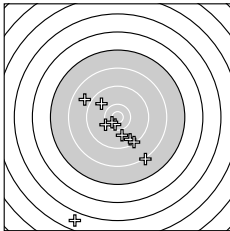
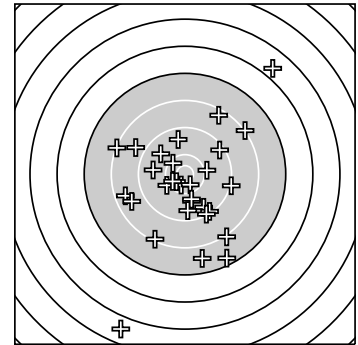

**Serie 1:**

9.5 ↘	10.5 *	10.2 ↙	10.5 *	9.8 ↖
9.9 ↓	9.3 ↘	8.9 ↖	4.8 ↓	8.2 ↘

beste Teiler: 335.0 (4.), 341.2 (2.), 629.1 (3.)  
 Trefferlage: 2.25 mm links, 8.79 mm tief  
 Streuwert: 12.71, horizontal: 9.69, vertikal: 15.14

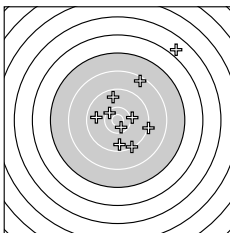

**Serie 2:**

10.4 ↖	9.8 ←	9.3 ↘	9.6 ↓	8.4 ↗
10.1 →	9.2 →	10.5 *	9.6 ↑	5.9 ↗

beste Teiler: 349.7 (18.), 479.2 (11.), 657.1 (16.)  
 Trefferlage: 4.97 mm rechts, 3.52 mm hoch  
 Streuwert: 11.66, horizontal: 10.00, vertikal: 13.11

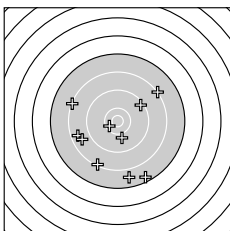

**Serie 3:**

9.4 ↗	8.3 ↖	10.4 *	8.2 ↗	8.6 ←
7.5 ↘	8.3 ↓	10.0 ↓	8.7 ↙	7.8 ↓

beste Teiler: 423.6 (23.), 763.5 (28.), 1247.2 (21.)  
 Trefferlage: 1.85 mm links, 6.51 mm tief  
 Streuwert: 13.41, horizontal: 13.41, vertikal: 13.42



Ergebnis: **286.2** (272)  
 Serien: 96.5 93.0 96.7  
 Zähler: 9 16 3 2 0 0 0 0 0 0  
 Innenzehner: 6  
 Weitesten: 2828 (16.), 2583 (18.), 2332 (13.)  
 beste Teiler: 304.5 (20.), 355.4 (12.), 362.0 (21.)  
 Trefferlage: 0.42 mm rechts, 2.11 mm hoch  
 Streuwert: 9.24, horizontal: 6.09, vertikal: 11.57

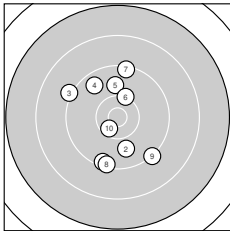
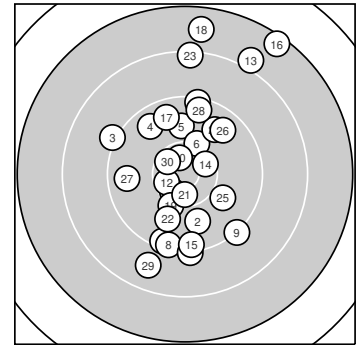

**Serie 1:**

9.4 ↘	9.9 ↓	9.2 ↖	9.6 ↖	9.9 ↑
10.2 ↗	9.3 ↑	9.3 ↓	9.2 ↘	10.5 *

beste Teiler: 374.2 (10.), 582.5 (6.), 857.3 (5.)  
 Trefferlage: 1.29 mm links, 0.44 mm tief  
 Streuwert: 8.08, horizontal: 5.92, vertikal: 9.77

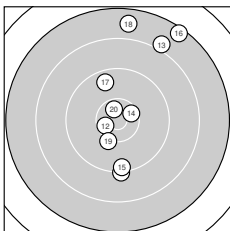

**Serie 2:**

9.2 ↓	10.5 *	8.0 ↗	10.4 *	9.4 ↓
7.4 ↗	9.6 ↖	7.7 ↑	10.2 ↓	10.6 *

beste Teiler: 304.5 (20.), 355.4 (12.), 405.1 (14.)  
 Trefferlage: 2.65 mm rechts, 5.03 mm hoch  
 Streuwert: 11.12, horizontal: 6.53, vertikal: 14.31

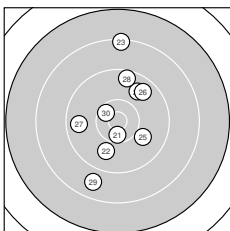

**Serie 3:**

10.5 *	9.9 ↘	8.3 ↑	9.8 ↗	10.0 ↘
9.7 ↗	9.7 ←	9.5 ↑	8.8 ↓	10.5 *

beste Teiler: 362.0 (21.), 379.8 (30.), 792.4 (25.)  
 Trefferlage: 0.08 mm links, 1.76 mm hoch  
 Streuwert: 8.56, horizontal: 5.70, vertikal: 10.68



**Ergebnis: 308.7 (296)**  
**Serien: 104.2 103.2 101.3**  
**Zähler: 26 4 0 0 0 0 0 0 0**  
**Innenzehner: 21**  
**Weiteste: 459 (30.), 312 (28.), 278 (22.)**  
**beste Teiler: 40.3 (10.), 59.4 (14.), 61.2 (11.)**  
**Trefferlage: 0.70 mm links, 0.25 mm tief**  
**Streuwert: 1.23, horizontal: 1.35, vertikal: 1.10**

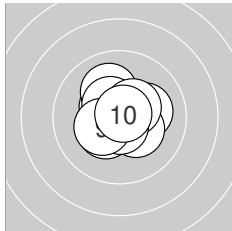
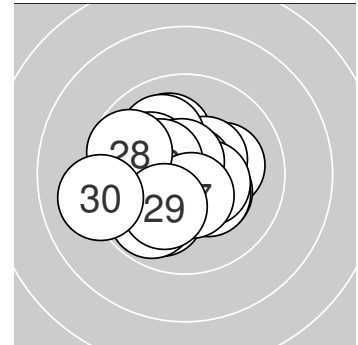

**Serie 1:**

10.5 *	10.2 *	10.1 ↗	10.5 *	10.4 *
10.3 *	10.4 *	10.7 *	10.3 *	10.8 *

**beste Teiler: 40.3 (10.), 67.0 (8.), 120.6 (4.)**  
**Trefferlage: 0.03 mm links, 0.19 mm hoch**  
**Streuwert: 1.07, horizontal: 1.14, vertikal: 1.00**

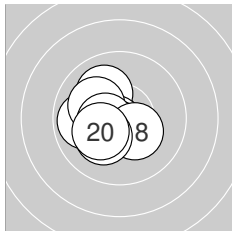

**Serie 2:**

10.7 *	9.9 ←	10.0 ↘	10.7 *	10.6 *
10.1 ↖	10.5 *	10.3 *	10.2 *	10.2 *

**beste Teiler: 59.4 (14.), 61.2 (11.), 88.3 (15.)**  
**Trefferlage: 0.95 mm links, 0.25 mm tief**  
**Streuwert: 1.03, horizontal: 1.04, vertikal: 1.02**

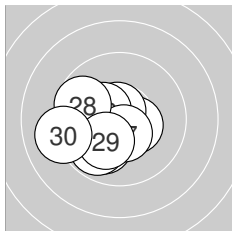

**Serie 3:**

10.0 ↙	9.8 ↙	10.6 *	10.4 *	10.7 *
10.4 *	10.5 *	9.7 ↖	10.1 ↙	9.1 ←

**beste Teiler: 68.4 (25.), 81.3 (23.), 116.7 (27.)**  
**Trefferlage: 1.11 mm links, 0.70 mm tief**  
**Streuwert: 1.44, horizontal: 1.66, vertikal: 1.18**



Ergebnis: **311.7** (298)  
 Serien: 103.3 105.0 103.4  
 Zähler: 28 2 0 0 0 0 0 0 0 0  
 Innenzehner: 25  
 Weitesten: 270 (21.), 260 (3.), 250 (2.)  
 beste Teiler: 13.3 (15.), 23.7 (14.), 37.0 (8.)  
 Trefferlage: 0.05 mm rechts, 0.18 mm tief  
 Streuwert: 1.14, horizontal: 1.17, vertikal: 1.11

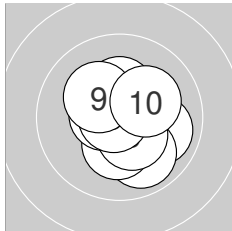
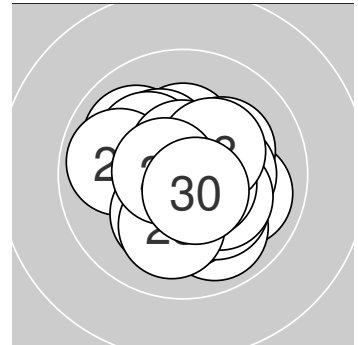

**Serie 1:**

10.6 *	10.0 ↗	9.9 ↘	10.3 *	10.6 *
10.4 *	10.3 *	10.8 *	10.2 *	10.2 *

beste Teiler: 37.0 (8.), 78.1 (1.), 96.0 (5.)  
 Trefferlage: 0.26 mm rechts, 0.16 mm tief  
 Streuwert: 1.25, horizontal: 1.22, vertikal: 1.27

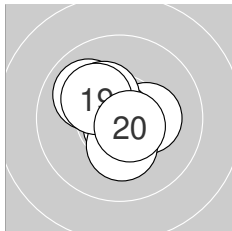

**Serie 2:**

10.8 *	10.0 ↖	10.3 *	10.9 *	10.9 *
10.3 *	10.7 *	10.3 *	10.2 *	10.6 *

beste Teiler: 13.3 (15.), 23.7 (14.), 43.6 (11.)  
 Trefferlage: 0.16 mm links, 0.09 mm hoch  
 Streuwert: 1.03, horizontal: 1.06, vertikal: 1.00

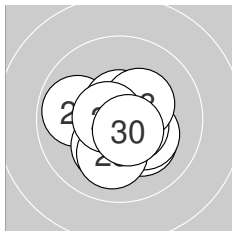

**Serie 3:**

9.9 ←	10.2 *	10.2 *	10.2 *	10.1 ↓
10.6 *	10.6 *	10.3 *	10.7 *	10.6 *

beste Teiler: 75.9 (29.), 87.0 (26.), 87.8 (30.)  
 Trefferlage: 0.08 mm rechts, 0.47 mm tief  
 Streuwert: 1.20, horizontal: 1.30, vertikal: 1.08



**Ergebnis:** 309.1 (298)  
**Serien:** 102.4 104.1 102.6  
**Zähler:** 28 2 0 0 0 0 0 0 0  
**Innenzehner:** 23  
**Weiteste:** 291 (30.), 257 (2.), 243 (9.)  
**beste Teiler:** 23.7 (19.), 92.8 (6.), 95.5 (22.)  
**Trefferlage:** 0.04 mm rechts, 0.55 mm hoch  
**Streuwert:** 1.17, horizontal: 1.34, vertikal: 0.96

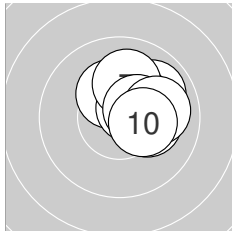
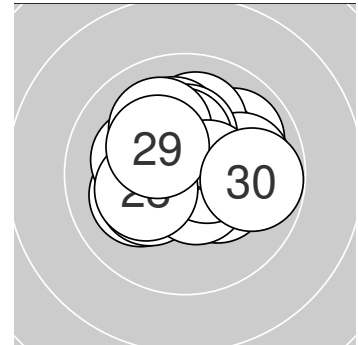

**Serie 1:**

10.3 *	9.9 ↗	10.3 *	10.3 *	10.2 *
10.6 *	10.1 ↑	10.4 *	10.0 →	10.3 *

**beste Teiler:** 92.8 (6.), 127.0 (8.), 155.3 (10.)  
**Trefferlage:** 1.07 mm rechts, 0.89 mm hoch  
**Streuwert:** 0.90, horizontal: 0.94, vertikal: 0.86

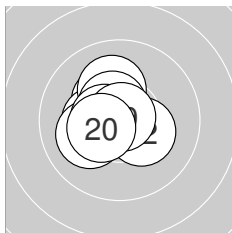

**Serie 2:**

10.6 *	10.3 *	10.3 *	10.3 *	10.1 ↑
10.5 *	10.1 ↙	10.6 *	10.9 *	10.4 *

**beste Teiler:** 23.7 (19.), 97.5 (18.), 100.6 (11.)  
**Trefferlage:** 0.64 mm links, 0.32 mm hoch  
**Streuwert:** 0.93, horizontal: 0.93, vertikal: 0.94

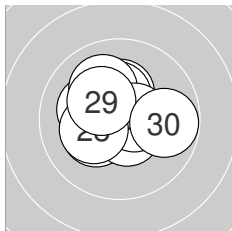

**Serie 3:**

10.2 *	10.6 *	10.3 *	10.2 *	10.3 *
10.1 ↘	10.6 *	10.2 *	10.3 *	9.8 →

**beste Teiler:** 95.5 (22.), 97.6 (27.), 153.0 (25.)  
**Trefferlage:** 0.31 mm links, 0.45 mm hoch  
**Streuwert:** 1.30, horizontal: 1.49, vertikal: 1.09





**Ergebnis:** **307.2** (293)  
**Serien:** 103.4 100.3 103.5  
**Zähler:** 23 7 0 0 0 0 0 0 0 0  
**Innenzehner:** 16  
**Weiteste:** 416 (19.), 307 (18.), 280 (20.)  
**beste Teiler:** 21.2 (22.), 33.8 (1.), 57.3 (6.)  
**Trefferlage:** 0.28 mm rechts, 0.27 mm hoch  
**Streuwert:** 1.40, horizontal: 1.57, vertikal: 1.20

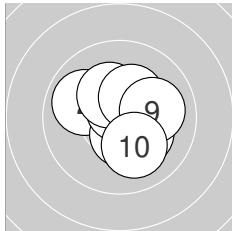
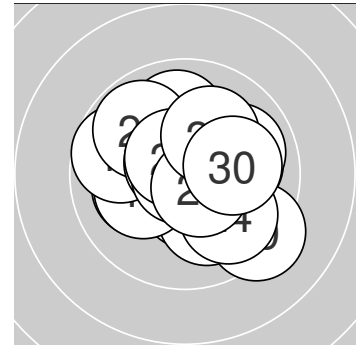

**Serie 1:**

10.8 *	9.9 ↖	10.6 *	10.2 *	10.5 *
10.7 *	10.3 *	10.3 *	10.0 →	10.1 ↘

**beste Teiler:** 33.8 (1.), 57.3 (6.), 89.6 (3.)  
**Trefferlage:** 0.32 mm rechts, 0.18 mm hoch  
**Streuwert:** 1.21, horizontal: 1.26, vertikal: 1.16

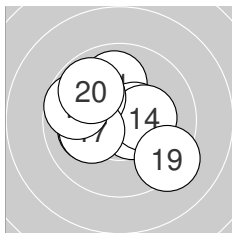

**Serie 2:**

9.9 ↑	10.5 *	10.6 *	10.3 *	10.1 ←
10.0 ↘	10.1 ←	9.7 ↖	9.3 ↘	9.8 ↘

**beste Teiler:** 97.4 (13.), 106.8 (12.), 167.7 (14.)  
**Trefferlage:** 0.41 mm links, 0.31 mm hoch  
**Streuwert:** 1.79, horizontal: 2.02, vertikal: 1.51

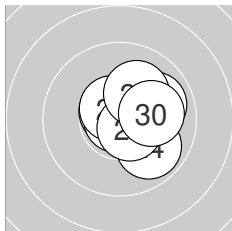

**Serie 3:**

10.7 *	10.9 *	9.9 →	9.9 ↘	10.2 *
10.5 *	10.6 *	10.6 *	10.1 ↗	10.1 →

**beste Teiler:** 21.2 (22.), 74.2 (21.), 88.4 (27.)  
**Trefferlage:** 0.95 mm rechts, 0.33 mm hoch  
**Streuwert:** 1.05, horizontal: 1.11, vertikal: 0.98



**Ergebnis: 306.6 (294)**  
**Serien: 100.7 104.2 101.7**  
**Zähler: 24 6 0 0 0 0 0 0 0 0**  
**Innenzehner: 21**  
**Weiteste: 440 (1.), 345 (10.), 339 (23.)**  
**beste Teiler: 30.1 (19.), 64.6 (20.), 96.4 (21.)**  
**Trefferlage: 0.17 mm links, 0.37 mm tief**  
**Streuwert: 1.43, horizontal: 1.57, vertikal: 1.27**

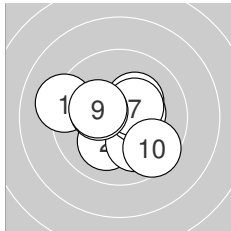
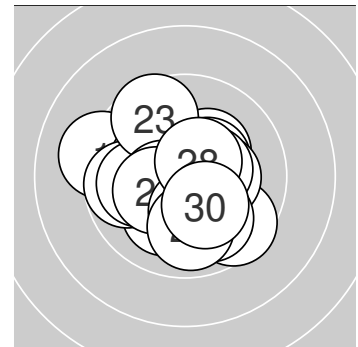

**Serie 1:**

9.2 ←	10.1 ↗	10.2 *	10.0 ↘	10.4 *
10.3 *	10.4 *	10.3 *	10.2 *	9.6 ↘

**beste Teiler: 136.3 (5.), 139.7 (7.), 166.7 (8.)**  
**Trefferlage: 0.00 mm , 0.31 mm tief**  
**Streuwert: 1.77, horizontal: 2.06, vertikal: 1.42**

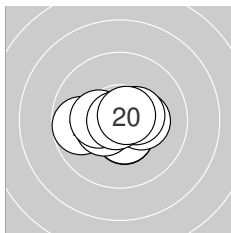

**Serie 2:**

9.8 ←	10.5 *	10.5 *	10.5 *	10.4 *
10.3 *	10.4 *	10.3 *	10.8 *	10.7 *

**beste Teiler: 30.1 (19.), 64.6 (20.), 118.9 (13.)**  
**Trefferlage: 0.30 mm links, 0.29 mm tief**  
**Streuwert: 1.08, horizontal: 1.42, vertikal: 0.55**

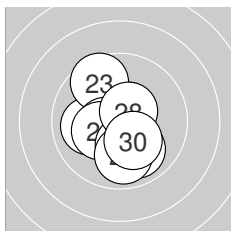

**Serie 3:**

10.6 *	10.0 ←	9.6 ↖	10.5 *	9.9 ↘
10.3 *	10.2 *	10.5 *	9.9 ↓	10.2 *

**beste Teiler: 96.4 (21.), 103.3 (28.), 116.1 (24.)**  
**Trefferlage: 0.21 mm links, 0.50 mm tief**  
**Streuwert: 1.49, horizontal: 1.27, vertikal: 1.69**



**Ergebnis:** **307.2** (295)  
**Serien:** 103.0 103.7 100.5  
**Zähler:** 25 5 0 0 0 0 0 0 0 0  
**Innenzehner:** 20  
**Weiteste:** 394 (25.), 340 (26.), 335 (3.)  
**beste Teiler:** 13.3 (18.), 24.6 (2.), 27.2 (8.)  
**Trefferlage:** 0.68 mm links, 0.13 mm tief  
**Streuwert:** 1.34, horizontal: 1.26, vertikal: 1.42

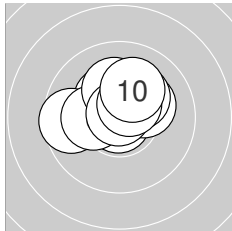
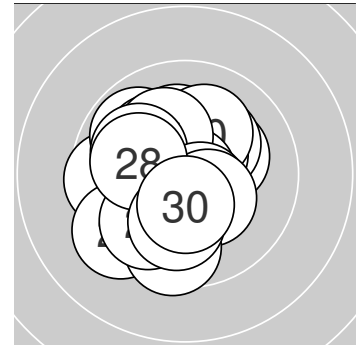

**Serie 1:**

10.3 *	10.9 *	9.6 ←	10.2 *	10.2 *
10.2 *	10.2 *	10.8 *	10.5 *	10.1 ↗

**beste Teiler:** 24.6 (2.), 27.2 (8.), 113.8 (9.)  
**Trefferlage:** 0.21 mm links, 0.79 mm hoch  
**Streuwert:** 1.22, horizontal: 1.52, vertikal: 0.82

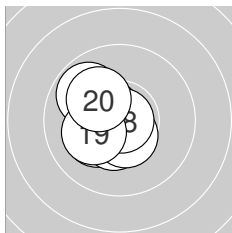

**Serie 2:**

9.8 ↘	10.6 *	10.6 *	10.4 *	10.2 *
10.4 *	10.5 *	10.9 *	10.2 *	10.1 ↘

**beste Teiler:** 13.3 (18.), 89.0 (13.), 90.5 (12.)  
**Trefferlage:** 0.92 mm links, 0.18 mm tief  
**Streuwert:** 0.97, horizontal: 0.83, vertikal: 1.09

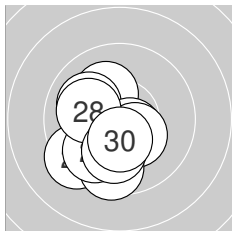

**Serie 3:**

10.2 *	10.0 ↘	10.5 *	10.3 *	9.4 ↗
9.6 ↓	9.9 ↙	10.1 ←	10.1 ↓	10.4 *

**beste Teiler:** 104.7 (23.), 141.0 (30.), 152.7 (24.)  
**Trefferlage:** 0.90 mm links, 1.02 mm tief  
**Streuwert:** 1.51, horizontal: 1.32, vertikal: 1.67



Ergebnis: **313.2** (298)  
 Serien: 105.3 104.7 103.2  
 Zähler: 28 2 0 0 0 0 0 0 0  
 Innenzehner: 26  
 Weitesten: 326 (21.), 258 (27.), 225 (20.)  
 beste Teiler: 11.1 (19.), 12.0 (30.), 34.2 (5.)  
 Trefferlage: 0.24 mm links, 0.36 mm hoch  
 Streuwert: 1.01, horizontal: 0.99, vertikal: 1.03

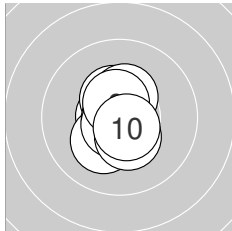
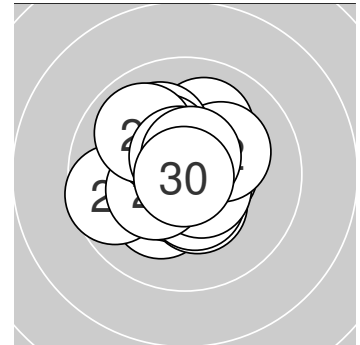

**Serie 1:**

10.5 *	10.7 *	10.2 *	10.4 *	10.8 *
10.7 *	10.4 *	10.6 *	10.4 *	10.6 *

beste Teiler: 34.2 (5.), 60.8 (6.), 72.4 (2.)  
 Trefferlage: 0.18 mm links, 0.07 mm hoch  
 Streuwert: 0.85, horizontal: 0.52, vertikal: 1.09

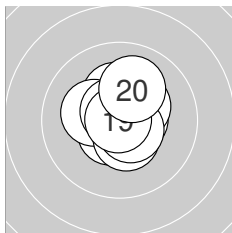

**Serie 2:**

10.3 *	10.5 *	10.6 *	10.2 *	10.3 *
10.5 *	10.6 *	10.7 *	10.9 *	10.1 ↗

beste Teiler: 11.1 (19.), 73.2 (18.), 96.5 (17.)  
 Trefferlage: 0.11 mm rechts, 0.33 mm hoch  
 Streuwert: 0.98, horizontal: 0.91, vertikal: 1.05

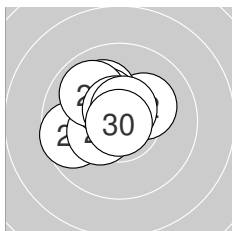

**Serie 3:**

9.6 ↙	10.2 *	10.1 ↘	10.4 *	10.6 *
10.3 *	9.9 ↘	10.6 *	10.6 *	10.9 *

beste Teiler: 12.0 (30.), 80.0 (25.), 83.4 (29.)  
 Trefferlage: 0.67 mm links, 0.67 mm hoch  
 Streuwert: 1.15, horizontal: 1.30, vertikal: 0.97



**Ergebnis:** **307.7** (295)  
**Serien:** 100.9 102.7 104.1  
**Zähler:** 25 5 0 0 0 0 0 0 0 0  
**Innenzehner:** 21  
**Weiteste:** 421 (12.), 368 (2.), 336 (6.)  
**beste Teiler:** 19.0 (18.), 23.0 (14.), 49.0 (9.)  
**Trefferlage:** 0.12 mm rechts, 0.28 mm tief  
**Streuwert:** 1.43, horizontal: 1.38, vertikal: 1.47

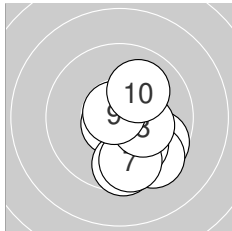
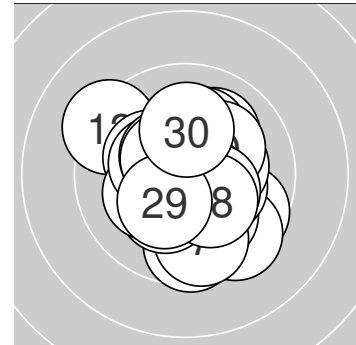

**Serie 1:**

9.7 ↘	9.5 ↘	10.7 *	10.7 *	10.0 ↘
9.6 ↓	9.7 ↓	10.2 *	10.8 *	10.0 ↗

**beste Teiler:** 49.0 (9.), 62.9 (4.), 68.6 (3.)  
**Trefferlage:** 1.00 mm rechts, 1.21 mm tief  
**Streuwert:** 1.40, horizontal: 1.08, vertikal: 1.66

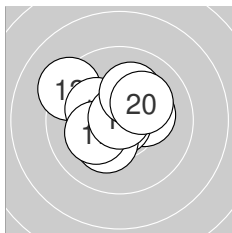

**Serie 2:**

10.5 *	9.3 ↘	10.2 *	10.9 *	10.2 *
10.2 *	10.2 *	10.9 *	10.1 ↗	10.2 *

**beste Teiler:** 19.0 (18.), 23.0 (14.), 114.2 (11.)  
**Trefferlage:** 0.47 mm links, 0.36 mm hoch  
**Streuwert:** 1.43, horizontal: 1.64, vertikal: 1.19

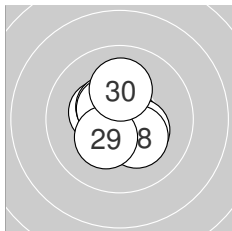

**Serie 3:**

10.4 *	10.7 *	10.6 *	10.5 *	10.4 *
10.5 *	10.3 *	10.3 *	10.3 *	10.1 ↑

**beste Teiler:** 51.0 (22.), 85.4 (23.), 111.1 (26.)  
**Trefferlage:** 0.15 mm links, 0.01 mm tief  
**Streuwert:** 1.06, horizontal: 0.98, vertikal: 1.14



Ergebnis: **307.9** (296)  
 Serien: 102.9 102.0 103.0  
 Zähler: 26 4 0 0 0 0 0 0 0 0  
 Innenzehner: 18  
 Weitester: 372 (16.), 295 (12.), 260 (10.)  
 beste Teiler: 10.4 (27.), 21.3 (18.), 62.5 (28.)  
 Trefferlage: 0.33 mm links, 0.65 mm tief  
 Streuwert: 1.28, horizontal: 1.47, vertikal: 1.05

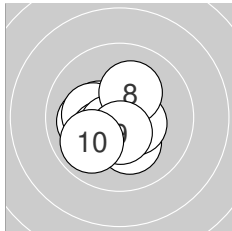
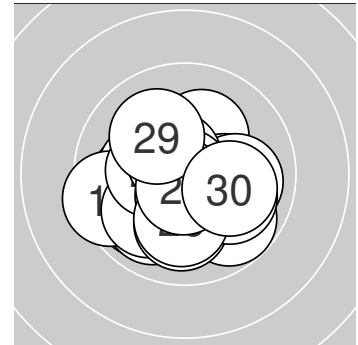

**Serie 1:**

10.4 *	10.1 ←	10.2 *	10.3 *	10.6 *
10.2 *	10.5 *	10.2 *	10.5 *	9.9 ↙

beste Teiler: 92.6 (5.), 109.2 (9.), 119.4 (7.)  
 Trefferlage: 0.67 mm links, 0.48 mm tief  
 Streuwert: 1.16, horizontal: 1.26, vertikal: 1.06

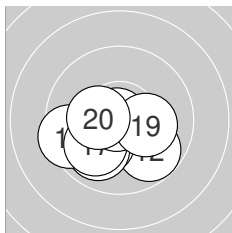

**Serie 2:**

10.6 *	9.8 ↘	10.2 *	9.9 ↙	10.6 *
9.5 ←	10.0 ↙	10.9 *	10.2 *	10.3 *

beste Teiler: 21.3 (18.), 91.9 (15.), 92.7 (11.)  
 Trefferlage: 0.75 mm links, 0.91 mm tief  
 Streuwert: 1.34, horizontal: 1.67, vertikal: 0.89

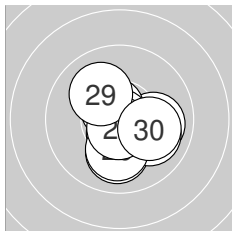

**Serie 3:**

10.0 ↓	10.0 →	10.6 *	10.0 ↘	10.5 *
10.1 ↓	10.9 *	10.7 *	10.1 ↘	10.1 →

beste Teiler: 10.4 (27.), 62.5 (28.), 89.0 (23.)  
 Trefferlage: 0.42 mm rechts, 0.57 mm tief  
 Streuwert: 1.25, horizontal: 1.29, vertikal: 1.22



Ergebnis: **306.8** (294)  
 Serien: 101.8 102.0 103.0  
 Zähler: 24 6 0 0 0 0 0 0 0 0  
 Innenzehner: 17  
 Weitest: 417 (1.), 358 (18.), 311 (9.)  
 beste Teiler: 18.0 (19.), 63.6 (12.), 70.1 (26.)  
 Trefferlage: 0.12 mm links, 0.07 mm tief  
 Streuwert: 1.46, horizontal: 1.58, vertikal: 1.32

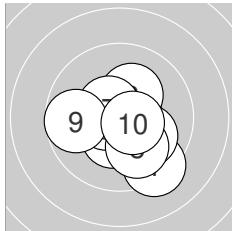
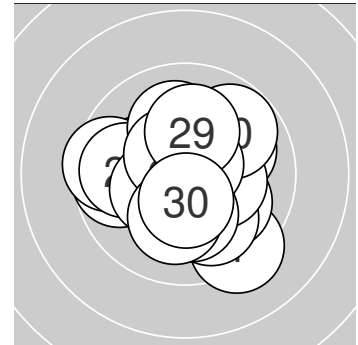

**Serie 1:**

9.3 ↘	10.6 *	10.2 *	10.4 *	10.0 ↘
10.6 *	10.5 *	10.0 ↘	9.7 ←	10.5 *

beste Teiler: 89.6 (2.), 94.4 (6.), 101.2 (10.)  
 Trefferlage: 0.27 mm rechts, 0.60 mm tief  
 Streuwert: 1.54, horizontal: 1.62, vertikal: 1.46

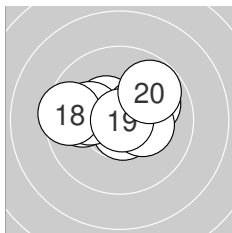

**Serie 2:**

10.0 ↗	10.7 *	10.4 *	9.9 ←	10.4 *
10.1 ←	10.3 *	9.5 ←	10.9 *	9.8 ↗

beste Teiler: 18.0 (19.), 63.6 (12.), 131.5 (13.)  
 Trefferlage: 0.17 mm links, 0.50 mm hoch  
 Streuwert: 1.54, horizontal: 2.05, vertikal: 0.75

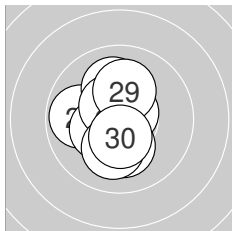

**Serie 3:**

10.6 *	9.8 ←	10.4 *	10.2 *	10.1 ↑
10.7 *	10.5 *	10.1 ↓	10.1 ↑	10.5 *

beste Teiler: 70.1 (26.), 95.3 (21.), 112.6 (27.)  
 Trefferlage: 0.46 mm links, 0.10 mm tief  
 Streuwert: 1.27, horizontal: 0.98, vertikal: 1.50



**Ergebnis:** 313.0 (298)  
**Serien:** 104.9 104.7 103.4  
**Zähler:** 28 2 0 0 0 0 0 0 0 0  
**Innenzehner:** 24  
**Weiteste:** 325 (25.), 271 (27.), 234 (13.)  
**beste Teiler:** 28.2 (18.), 32.6 (5.), 36.1 (23.)  
**Trefferlage:** 0.04 mm links, 0.04 mm tief  
**Streuwert:** 1.08, horizontal: 1.10, vertikal: 1.07

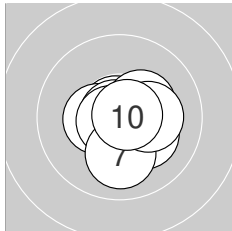
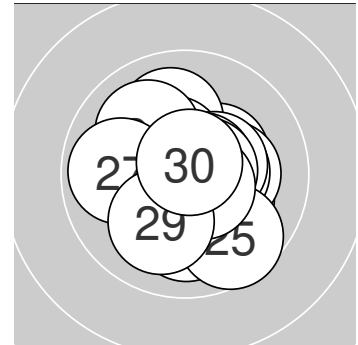

**Serie 1:**

10.8 *	10.7 *	10.2 *	10.4 *	10.8 *
10.7 *	10.0 ↓	10.3 *	10.2 *	10.8 *

**beste Teiler:** 32.6 (5.), 46.0 (1.), 50.2 (10.)  
**Trefferlage:** 0.22 mm rechts, 0.23 mm tief  
**Streuwert:** 0.96, horizontal: 1.05, vertikal: 0.86

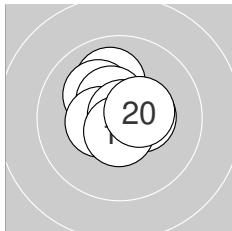

**Serie 2:**

10.7 *	10.6 *	10.0 ↑	10.2 *	10.5 *
10.4 *	10.5 *	10.8 *	10.6 *	10.4 *

**beste Teiler:** 28.2 (18.), 56.6 (11.), 83.0 (19.)  
**Trefferlage:** 0.20 mm links, 0.43 mm hoch  
**Streuwert:** 0.93, horizontal: 0.93, vertikal: 0.94

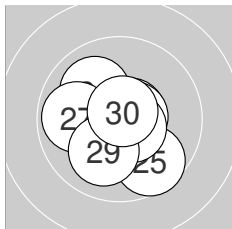

**Serie 3:**

10.4 *	10.6 *	10.8 *	10.0 ↘	9.7 ↘
10.6 *	9.9 ←	10.6 *	10.1 ↙	10.7 *

**beste Teiler:** 36.1 (23.), 53.4 (30.), 76.5 (22.)  
**Trefferlage:** 0.14 mm links, 0.34 mm tief  
**Streuwert:** 1.32, horizontal: 1.34, vertikal: 1.30





Ergebnis: **305.7** (292)  
 Serien: 102.1 101.1 102.5  
 Zähler: 22 8 0 0 0 0 0 0 0 0  
 Innenzehner: 19  
 Weitesten: 451 (2.), 421 (17.), 393 (20.)  
 beste Teiler: 46.3 (3.), 76.8 (10.), 94.9 (24.)  
 Trefferlage: 0.13 mm rechts, 0.52 mm tief  
 Streuwert: 1.50, horizontal: 1.95, vertikal: 0.85

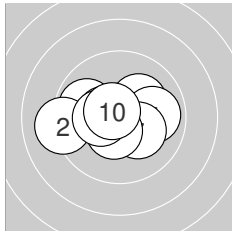
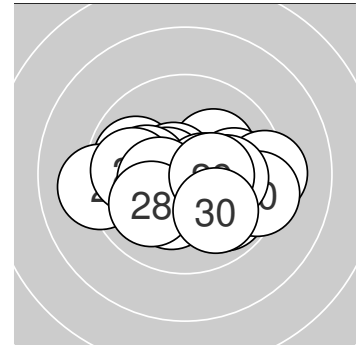

**Serie 1:**

9.9 ←	9.1 ←	10.8 *	10.2 *	9.9 →
10.5 *	10.2 *	10.5 *	10.4 *	10.6 *

beste Teiler: 46.3 (3.), 76.8 (10.), 115.6 (8.)  
 Trefferlage: 0.53 mm links, 0.05 mm hoch  
 Streuwert: 1.57, horizontal: 2.08, vertikal: 0.76

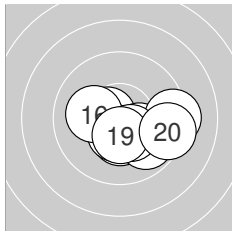

**Serie 2:**

10.6 *	10.3 *	10.2 *	10.5 *	9.9 ↘
10.1 ←	9.3 →	10.4 *	10.4 *	9.4 →

beste Teiler: 98.4 (11.), 122.2 (14.), 134.1 (19.)  
 Trefferlage: 0.93 mm rechts, 0.84 mm tief  
 Streuwert: 1.51, horizontal: 2.00, vertikal: 0.76

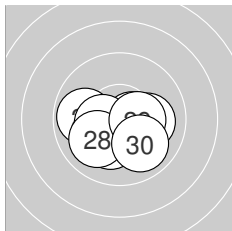

**Serie 3:**

10.1 →	10.6 *	10.2 *	10.6 *	9.9 ←
10.4 *	10.4 *	10.0 ↙	10.4 *	9.9 ↘

beste Teiler: 94.9 (24.), 99.3 (22.), 136.3 (26.)  
 Trefferlage: 0.02 mm rechts, 0.76 mm tief  
 Streuwert: 1.28, horizontal: 1.63, vertikal: 0.78



**Ergebnis: 310.3 (297)**  
**Serien: 102.6 103.0 104.7**  
**Zähler: 27 3 0 0 0 0 0 0 0 0**  
**Innenzehner: 18**  
**Weiteste: 399 (27.), 269 (14.), 253 (8.)**  
**beste Teiler: 6.0 (2.), 29.4 (21.), 33.6 (23.)**  
**Trefferlage: 0.19 mm links, 0.39 mm hoch**  
**Streuwert: 1.22, horizontal: 1.37, vertikal: 1.05**

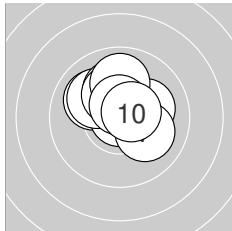
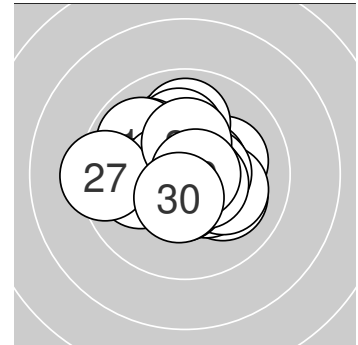

**Serie 1:**

10.0 ↘	10.9 *	10.1 ↘	10.1 ↑	10.2 *
10.1 →	10.1 ↘	9.9 ↑	10.6 *	10.6 *

**beste Teiler: 6.0 (2.), 92.0 (9.), 96.1 (10.)**  
**Trefferlage: 0.01 mm links, 0.99 mm hoch**  
**Streuwert: 1.18, horizontal: 1.31, vertikal: 1.04**

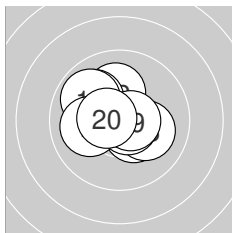

**Serie 2:**

10.6 *	10.1 ↑	10.0 ↘	9.9 ↘	10.4 *
10.1 ↘	10.0 ←	10.7 *	10.6 *	10.6 *

**beste Teiler: 70.7 (18.), 83.0 (19.), 95.6 (11.)**  
**Trefferlage: 0.39 mm links, 0.33 mm hoch**  
**Streuwert: 1.28, horizontal: 1.46, vertikal: 1.06**

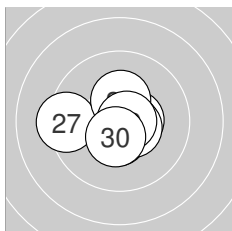

**Serie 3:**

10.8 *	10.5 *	10.8 *	10.7 *	10.5 *
10.5 *	9.4 ←	10.3 *	10.7 *	10.5 *

**beste Teiler: 29.4 (21.), 33.6 (23.), 53.0 (29.)**  
**Trefferlage: 0.16 mm links, 0.15 mm tief**  
**Streuwert: 1.15, horizontal: 1.44, vertikal: 0.75**



**Ergebnis:** **310.6** (297)  
**Serien:** 103.4 104.0 103.2  
**Zähler:** 27 3 0 0 0 0 0 0 0  
**Innenzehner:** 23  
**Weiteste:** 387 (6.), 324 (21.), 252 (20.)  
**beste Teiler:** 26.4 (19.), 48.0 (17.), 50.3 (22.)  
**Trefferlage:** 0.21 mm rechts, 0.10 mm hoch  
**Streuwert:** 1.21, horizontal: 1.55, vertikal: 0.73

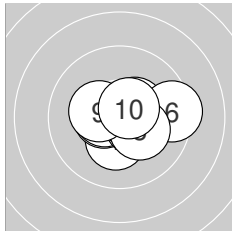
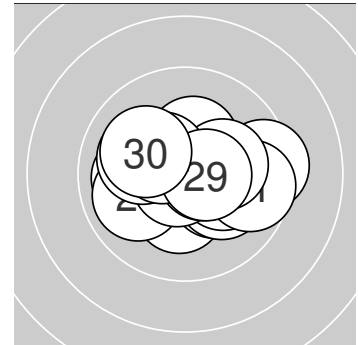

**Serie 1:**  
 10.3 \*                      10.5 \*                      10.5 \*                      10.4 \*                      10.4 \*  
 9.4 →                      10.7 \*                      10.3 \*                      10.3 \*                      10.6 \*  
**beste Teiler:** 58.5 (7.), 94.7 (10.), 109.2 (3.)  
**Trefferlage:** 0.48 mm rechts, 0.06 mm tief  
**Streuwert:** 1.25, horizontal: 1.59, vertikal: 0.75

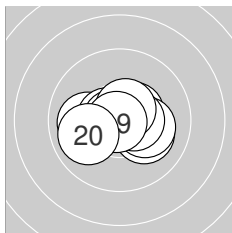

**Serie 2:**  
 10.0 ←                      10.5 \*                      10.1 ↘                      10.2 \*                      10.6 \*  
 10.5 \*                      10.8 \*                      10.6 \*                      10.8 \*                      9.9 ←  
**beste Teiler:** 26.4 (19.), 48.0 (17.), 90.2 (15.)  
**Trefferlage:** 0.00 mm , 0.12 mm tief  
**Streuwert:** 1.16, horizontal: 1.53, vertikal: 0.59

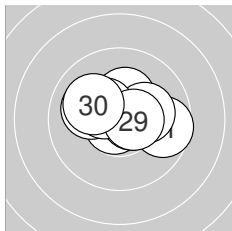

**Serie 3:**  
 9.7 →                      10.8 \*                      10.6 \*                      10.5 \*                      10.1 ↖  
 10.3 \*                      10.2 \*                      10.4 \*                      10.5 \*                      10.1 ↖  
**beste Teiler:** 50.3 (22.), 89.0 (23.), 103.0 (29.)  
**Trefferlage:** 0.18 mm rechts, 0.49 mm hoch  
**Streuwert:** 1.28, horizontal: 1.65, vertikal: 0.72



Ergebnis: **246.1** (234)  
 Serien: 80.6 82.4 83.1  
 Zähler: 3 6 7 11 2 1 0 0 0 0  
 Innenzehner: 0  
 Weitesten: 4284 (30.), 3470 (12.), 3362 (6.)  
 beste Teiler: 504.1 (15.), 760.7 (9.), 784.6 (14.)  
 Trefferlage: 12.98 mm rechts, 3.21 mm hoch  
 Streuwert: 14.17, horizontal: 10.12, vertikal: 17.29

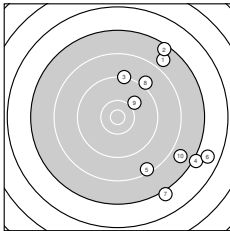
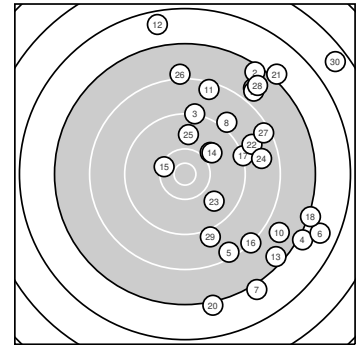

**Serie 1:**

7.8 ↗	7.4 ↗	9.2 ↑	7.1 ↘	8.4 ↘
6.7 ↘	7.1 ↘	9.1 ↗	10.0 ↗	7.8 ↘

beste Teiler: 760.7 (9.), 1392.9 (3.), 1520.3 (8.)  
 Trefferlage: 15.46 mm rechts, 1.23 mm tief  
 Streuwert: 14.13, horizontal: 9.04, vertikal: 17.82

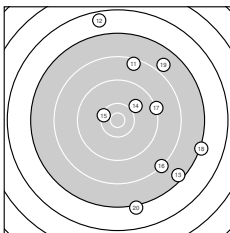

**Serie 2:**

8.4 ↑	6.6 ↑	7.5 ↘	10.0 ↗	10.3 ↖
8.2 ↘	9.2 →	7.2 ↘	7.9 ↗	7.1 ↓

beste Teiler: 504.1 (15.), 784.6 (14.), 1391.5 (17.)  
 Trefferlage: 10.03 mm rechts, 0.90 mm hoch  
 Streuwert: 15.95, horizontal: 10.87, vertikal: 19.77

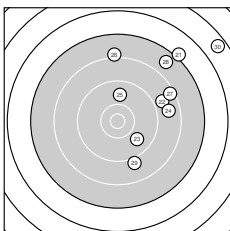

**Serie 3:**

7.1 ↗	8.9 →	9.8 ↘	8.7 →	9.8 ↑
8.1 ↑	8.4 →	7.7 ↗	9.0 ↘	5.6 ↗

beste Teiler: 905.4 (25.), 906.4 (23.), 1543.6 (29.)  
 Trefferlage: 13.46 mm rechts, 9.98 mm hoch  
 Streuwert: 12.02, horizontal: 10.64, vertikal: 13.26



Ergebnis: **293.9** (281)  
 Serien: 99.5 93.4 101.0  
 Zähler: 15 12 2 1 0 0 0 0 0 0  
 Innenzehner: 6  
 Weitester: 2791 (17.), 2265 (18.), 2252 (12.)  
 beste Teiler: 199.0 (24.), 229.7 (5.), 236.2 (3.)  
 Trefferlage: 2.85 mm links, 0.70 mm hoch  
 Streuwert: 7.76, horizontal: 7.77, vertikal: 7.74

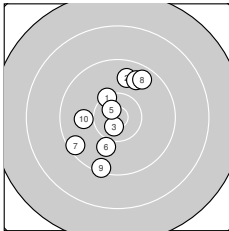
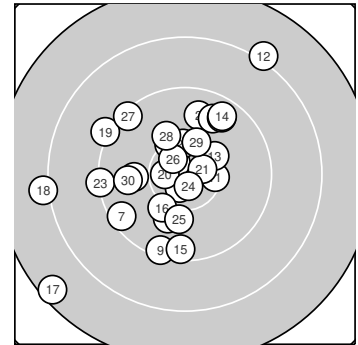

**Serie 1:**

10.3 ↘	9.8 ↑	10.7 *	9.7 ↗	10.7 *
10.0 ↓	9.4 ↙	9.6 ↗	9.4 ↓	9.9 ←

beste Teiler: 229.7 (5.), 236.2 (3.), 530.5 (1.)  
 Trefferlage: 1.72 mm links, 0.51 mm hoch  
 Streuwert: 6.41, horizontal: 5.02, vertikal: 7.55

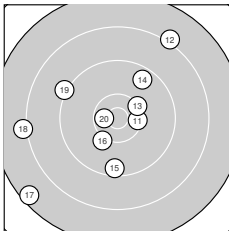

**Serie 2:**

10.4 →	8.1 ↗	10.3 ↘	9.6 ↗	9.5 ↓
10.1 ↙	7.5 ↙	8.1 ←	9.2 ↖	10.6 *

beste Teiler: 320.0 (20.), 480.4 (11.), 553.1 (13.)  
 Trefferlage: 3.58 mm links, 0.10 mm tief  
 Streuwert: 11.16, horizontal: 11.74, vertikal: 10.56

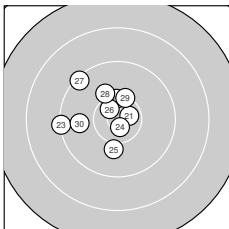

**Serie 3:**

10.6 *	10.3 ↑	9.3 ←	10.7 *	10.0 ↓
10.6 *	9.3 ↘	10.1 ↘	10.3 ↗	9.8 ←

beste Teiler: 199.0 (24.), 289.2 (21.), 306.1 (26.)  
 Trefferlage: 3.25 mm links, 1.70 mm hoch  
 Streuwert: 5.11, horizontal: 5.42, vertikal: 4.78



Ergebnis: **260.4** (247)  
 Serien: 79.4 92.3 88.7  
 Zähler: 2 12 9 5 2 0 0 0 0 0  
 Innenzehner: 1  
 Weitesten: 3755 (6.), 3278 (9.), 3171 (10.)  
 beste Teiler: 285.6 (21.), 666.3 (19.), 817.0 (18.)  
 Trefferlage: 0.24 mm links, 2.45 mm hoch  
 Streuwert: 14.43, horizontal: 6.91, vertikal: 19.20

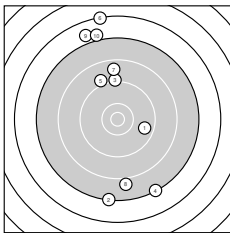
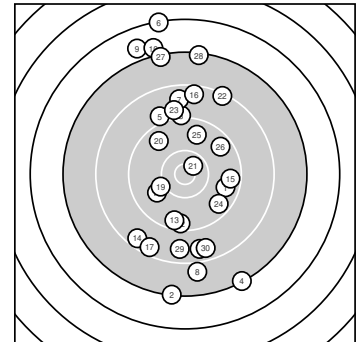

**Serie 1:**  
 9.7 →                      7.3 ↓                      9.2 ↑                      7.3 ↓                      9.0 ↑  
 6.3 ↑                      8.7 ↑                      8.0 ↓                      6.9 ↑                      7.0 ↑  
 beste Teiler: 1039.7 (1.), 1438.0 (3.), 1539.6 (5.)  
 Trefferlage: 1.07 mm links, 6.26 mm hoch  
 Streuwert: 18.71, horizontal: 8.00, vertikal: 25.21

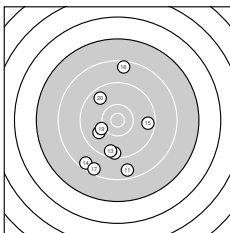

**Serie 2:**  
 8.6 ↓                      9.4 ↓                      9.5 ↓                      8.5 ↙                      9.6 →  
 8.5 ↑                      8.5 ↘                      9.9 ↙                      10.1 ↙                      9.7 ↘  
 beste Teiler: 666.3 (19.), 817.0 (18.), 1029.5 (20.)  
 Trefferlage: 2.61 mm links, 5.60 mm tief  
 Streuwert: 9.83, horizontal: 6.77, vertikal: 12.14

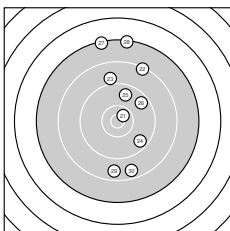

**Serie 3:**  
 10.6 \*                      8.3 ↗                      9.0 ↑                      9.6 ↘                      9.7 ↑  
 9.6 ↗                      7.3 ↑                      7.3 ↑                      8.7 ↓                      8.6 ↓  
 beste Teiler: 285.6 (21.), 1003.5 (25.), 1095.7 (26.)  
 Trefferlage: 2.94 mm rechts, 6.71 mm hoch  
 Streuwert: 12.69, horizontal: 5.08, vertikal: 17.22



Ergebnis: **291.2** (277)  
 Serien: 97.1 97.4 96.7  
 Zähler: 9 19 2 0 0 0 0 0 0 0  
 Innenzehner: 4  
 Weitester: 1890 (14.), 1690 (8.), 1582 (24.)  
 beste Teiler: 288.0 (16.), 302.2 (26.), 310.0 (27.)  
 Trefferlage: 4.93 mm rechts, 1.30 mm tief  
 Streuwert: 6.85, horizontal: 5.81, vertikal: 7.76

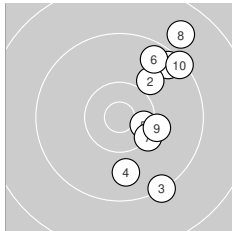
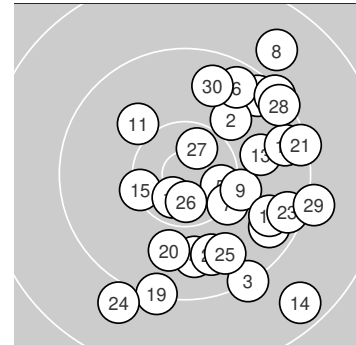

**Serie 1:**  
 9.5 ↗ 10.0 ↗ 9.3 ↘ 9.8 ↓ 10.4 \*  
 9.6 ↗ 10.2 ↘ 8.8 ↗ 10.2 → 9.3 ↗  
 beste Teiler: 414.9 (5.), 570.4 (7.), 635.9 (9.)  
 Trefferlage: 6.12 mm rechts, 1.92 mm hoch  
 Streuwert: 6.34, horizontal: 2.74, vertikal: 8.53

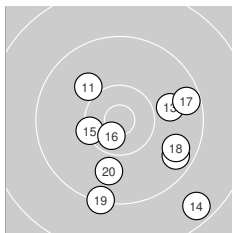

**Serie 2:**  
 10.0 ↘ 9.6 ↘ 9.9 → 8.6 ↘ 10.3 ←  
 10.6 \* 9.5 → 9.7 ↘ 9.3 ↓ 9.9 ↓  
 beste Teiler: 288.0 (16.), 520.5 (15.), 752.7 (11.)  
 Trefferlage: 3.40 mm rechts, 3.93 mm tief  
 Streuwert: 6.91, horizontal: 7.21, vertikal: 6.61

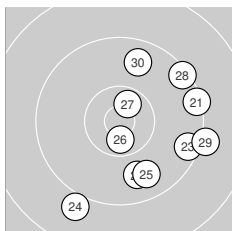

**Serie 3:**  
 9.3 → 9.8 ↓ 9.5 → 9.0 ↓ 9.7 ↘  
 10.6 \* 10.6 \* 9.4 ↗ 9.1 → 9.7 ↑  
 beste Teiler: 302.2 (26.), 310.0 (27.), 927.1 (22.)  
 Trefferlage: 5.28 mm rechts, 1.89 mm tief  
 Streuwert: 7.17, horizontal: 6.71, vertikal: 7.61







Ergebnis: **294.6** (281)  
 Serien: 97.9 99.5 97.2  
 Zähler: 13 15 2 0 0 0 0 0 0  
 Innenzehner: 7  
 Weitestе: 2140 (28.), 1977 (3.), 1597 (8.)  
 beste Teiler: 215.1 (18.), 220.7 (2.), 243.3 (16.)  
 Trefferlage: 1.18 mm links, 1.08 mm tief  
 Streuwert: 7.36, horizontal: 7.14, vertikal: 7.58

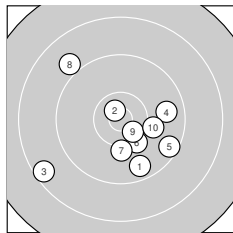
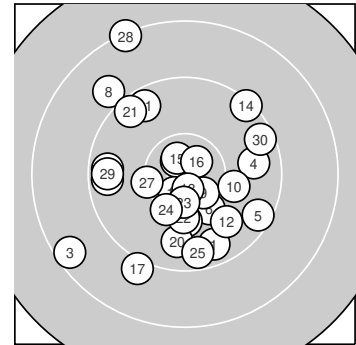

**Serie 1:**  
 9.6 ↘                      10.7 \*                      8.5 ↙                      9.7 →                      9.5 ↘  
 10.2 ↘                      10.1 ↓                      9.0 ↘                      10.5 \*                      10.1 →  
 beste Teiler: 220.7 (2.), 373.3 (9.), 601.7 (6.)  
 Trefferlage: 0.91 mm rechts, 2.77 mm tief  
 Streuwert: 7.70, horizontal: 8.60, vertikal: 6.68

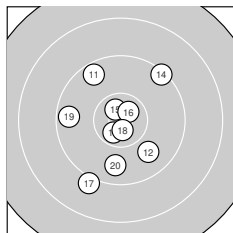

**Serie 2:**  
 9.5 ↘                      9.8 ↘                      10.6 \*                      9.3 ↗                      10.6 \*  
 10.6 \*                      9.1 ↙                      10.7 \*                      9.6 ←                      9.7 ↓  
 beste Teiler: 215.1 (18.), 243.3 (16.), 252.6 (15.)  
 Trefferlage: 1.05 mm links, 1.02 mm tief  
 Streuwert: 6.76, horizontal: 5.84, vertikal: 7.58

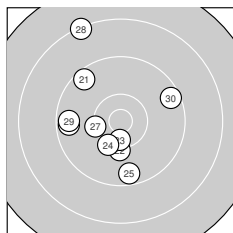

**Serie 3:**  
 9.5 ↘                      10.2 ↓                      10.5 \*                      10.2 ↙                      9.5 ↓  
 9.6 ←                      10.3 ←                      8.3 ↗                      9.6 ←                      9.5 →  
 beste Teiler: 399.3 (23.), 550.9 (27.), 569.8 (24.)  
 Trefferlage: 3.40 mm links, 0.53 mm hoch  
 Streuwert: 7.84, horizontal: 6.77, vertikal: 8.78



Ergebnis: **289.2** (272)  
 Serien: 95.5 98.9 94.8  
 Zähler: 8 16 6 0 0 0 0 0 0 0  
 Innenzehner: 5  
 Weitesten: 2016 (8.), 1955 (5.), 1889 (12.)  
 beste Teiler: 69.2 (18.), 247.1 (2.), 309.0 (15.)  
 Trefferlage: 2.72 mm rechts, 0.46 mm tief  
 Streuwert: 8.20, horizontal: 6.02, vertikal: 9.91

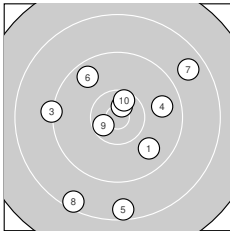
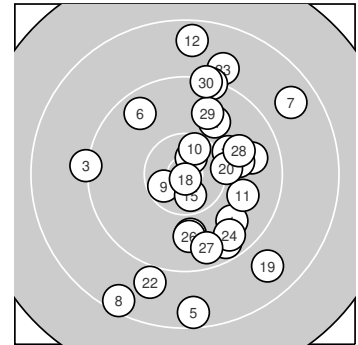

**Serie 1:**

9.8 ↘	10.6 *	9.2 ←	9.7 →	8.5 ↓
9.6 ↘	8.7 ↗	8.4 ↙	10.5 *	10.5 *

beste Teiler: 247.1 (2.), 343.8 (9.), 382.0 (10.)  
 Trefferlage: 0.17 mm rechts, 1.76 mm tief  
 Streuwert: 9.46, horizontal: 8.78, vertikal: 10.09

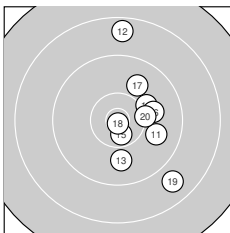

**Serie 2:**

9.9 →	8.6 ↑	9.9 ↓	10.1 →	10.6 *
10.0 →	9.9 ↗	10.9 *	8.8 ↘	10.2 →

beste Teiler: 69.2 (18.), 309.0 (15.), 592.5 (20.)  
 Trefferlage: 4.62 mm rechts, 0.38 mm hoch  
 Streuwert: 6.75, horizontal: 3.92, vertikal: 8.70

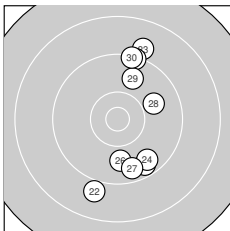

**Serie 3:**

9.5 ↘	8.9 ↓	9.0 ↑	9.6 ↘	9.3 ↑
9.9 ↓	9.6 ↓	9.9 →	9.8 ↑	9.3 ↑

beste Teiler: 833.1 (28.), 880.9 (26.), 917.6 (29.)  
 Trefferlage: 3.37 mm rechts, 0.01 mm tief  
 Streuwert: 8.62, horizontal: 3.55, vertikal: 11.67



Ergebnis: **292.7** (279)  
 Serien: 94.9 97.5 100.3  
 Zähler: 12 15 3 0 0 0 0 0 0 0  
 Innenzehner: 5  
 Weitester: 2295 (20.), 1764 (10.), 1655 (17.)  
 beste Teiler: 80.2 (24.), 246.7 (11.), 329.8 (13.)  
 Trefferlage: 2.99 mm rechts, 0.91 mm tief  
 Streuwert: 7.32, horizontal: 4.53, vertikal: 9.30

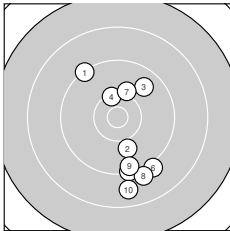
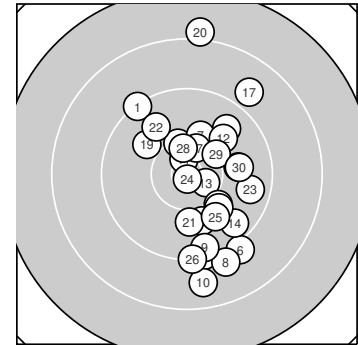

**Serie 1:**  
 9.3 ↘ 10.0 ↓ 9.7 ↗ 10.3 ↑ 9.3 ↓  
 9.1 ↘ 10.1 ↑ 9.0 ↓ 9.4 ↓ 8.7 ↓  
 beste Teiler: 518.6 (4.), 663.2 (7.), 788.4 (2.)  
 Trefferlage: 2.45 mm rechts, 4.67 mm tief  
 Streuwert: 8.26, horizontal: 4.61, vertikal: 10.73

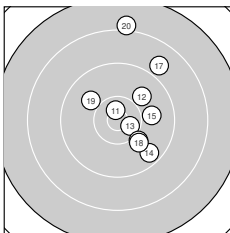

**Serie 2:**  
 10.6 \* 9.9 ↗ 10.5 \* 9.6 ↘ 9.9 →  
 10.1 ↘ 8.9 ↗ 10.0 ↘ 9.9 ↖ 8.1 ↑  
 beste Teiler: 246.7 (11.), 329.8 (13.), 701.5 (16.)  
 Trefferlage: 4.00 mm rechts, 3.05 mm hoch  
 Streuwert: 7.41, horizontal: 4.79, vertikal: 9.33

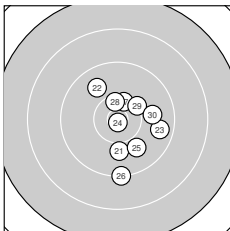

**Serie 3:**  
 10.0 ↓ 9.8 ↘ 9.6 → 10.9 \* 9.9 ↓  
 9.2 ↓ 10.4 \* 10.4 \* 10.2 ↗ 9.9 →  
 beste Teiler: 80.2 (24.), 422.4 (28.), 445.6 (27.)  
 Trefferlage: 2.51 mm rechts, 1.12 mm tief  
 Streuwert: 5.65, horizontal: 4.51, vertikal: 6.60



Ergebnis: **292.5** (279)  
 Serien: 98.9 100.5 93.1  
 Zähler: 13 13 4 0 0 0 0 0 0 0  
 Innenzehner: 6  
 Weitester: 2025 (30.), 1875 (28.), 1767 (10.)  
 beste Teiler: 25.3 (12.), 217.8 (14.), 265.6 (6.)  
 Trefferlage: 2.33 mm links, 1.21 mm hoch  
 Streuwert: 7.60, horizontal: 6.61, vertikal: 8.47

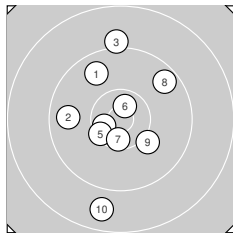
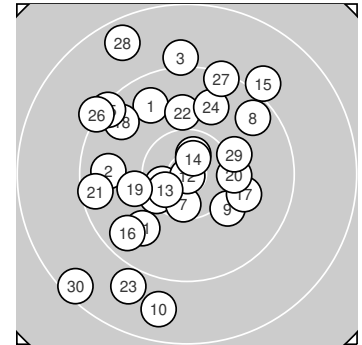

**Serie 1:**  
 9.7 ↘                      9.7 ←                      9.1 ↑                      10.5 \*                      10.4 ↙  
 10.6 \*                      10.5 \*                      9.6 ↗                      10.1 ↘                      8.7 ↓  
 beste Teiler: 265.6 (6.), 341.1 (4.), 389.8 (7.)  
 Trefferlage: 1.22 mm links, 0.42 mm hoch  
 Streuwert: 7.25, horizontal: 5.23, vertikal: 8.82

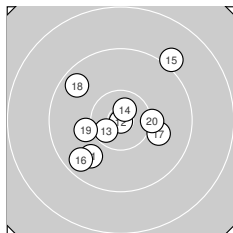

**Serie 2:**  
 9.8 ↙                      10.9 \*                      10.5 \*                      10.7 \*                      9.1 ↗  
 9.6 ↙                      10.0 →                      9.6 ↘                      10.1 ←                      10.2 →  
 beste Teiler: 25.3 (12.), 217.8 (14.), 342.6 (13.)  
 Trefferlage: 0.73 mm links, 0.09 mm tief  
 Streuwert: 6.22, horizontal: 6.62, vertikal: 5.80

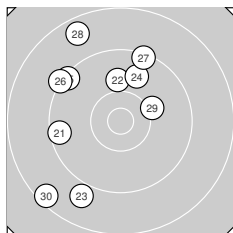

**Serie 3:**  
 9.5 ←                      10.0 ↑                      8.9 ↙                      9.8 ↑                      9.3 ↘  
 9.2 ↘                      9.3 ↑                      8.6 ↘                      10.1 →                      8.4 ↙  
 beste Teiler: 658.0 (29.), 793.1 (22.), 914.5 (24.)  
 Trefferlage: 5.05 mm links, 3.30 mm hoch  
 Streuwert: 9.20, horizontal: 7.56, vertikal: 10.59



Ergebnis: **301.9** (290)  
 Serien: 97.7 101.5 102.7  
 Zähler: 22 7 0 1 0 0 0 0 0 0  
 Innenzehner: 9  
 Weitester: 2531 (1.), 1580 (8.), 1508 (10.)  
 beste Teiler: 163.2 (4.), 245.9 (17.), 265.0 (21.)  
 Trefferlage: 1.20 mm rechts, 2.46 mm tief  
 Streuwert: 5.82, horizontal: 5.12, vertikal: 6.44

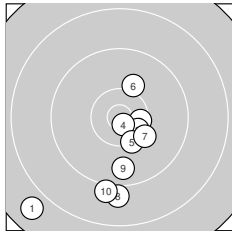
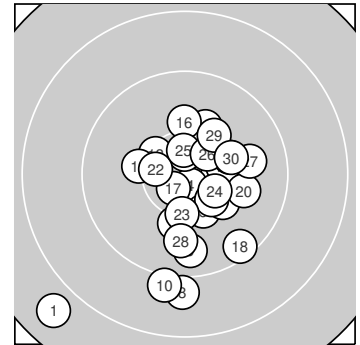

**Serie 1:**

7.8 ↙	10.4 *	10.4 *	10.7 *	10.3 ↘
10.1 ↗	10.2 ↘	9.0 ↓	9.7 ↓	9.1 ↓

beste Teiler: 163.2 (4.), 422.3 (2.), 440.7 (3.)  
 Trefferlage: 0.11 mm links, 6.60 mm tief  
 Streuwert: 7.24, horizontal: 6.55, vertikal: 7.87

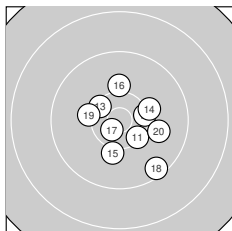

**Serie 2:**

10.3 ↘	10.3 →	10.4 ↘	10.2 →	10.1 ↓
10.1 ↑	10.6 *	9.4 ↘	10.2 ←	9.9 →

beste Teiler: 245.9 (17.), 479.6 (13.), 494.3 (11.)  
 Trefferlage: 1.66 mm rechts, 0.96 mm tief  
 Streuwert: 4.89, horizontal: 4.95, vertikal: 4.84

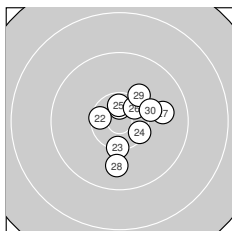

**Serie 3:**

10.6 *	10.5 *	10.3 ↓	10.4 *	10.6 *
10.5 *	9.8 →	9.8 ↓	10.1 ↗	10.1 →

beste Teiler: 265.0 (21.), 318.5 (25.), 398.5 (22.)  
 Trefferlage: 2.06 mm rechts, 0.18 mm hoch  
 Streuwert: 4.07, horizontal: 3.76, vertikal: 4.36



Ergebnis: **289.5** (275)  
 Serien: 97.3 93.8 98.4  
 Zähler: 14 11 2 2 1 0 0 0 0 0  
 Innenzehner: 8  
 Weitesten: 3203 (3.), 2731 (13.), 2416 (21.)  
 beste Teiler: 116.1 (28.), 134.1 (15.), 269.5 (24.)  
 Trefferlage: 4.00 mm links, 2.88 mm tief  
 Streuwert: 8.51, horizontal: 6.86, vertikal: 9.89

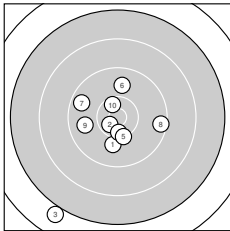
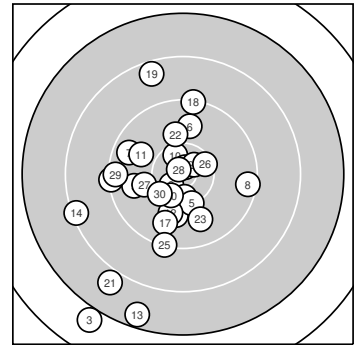

**Serie 1:**

10.0 ↓	10.6 *	6.9 ↙	10.4 *	10.3 ↓
9.8 ↑	9.6 ↖	9.4 →	9.8 ←	10.5 *

beste Teiler: 294.3 (2.), 378.6 (10.), 420.0 (4.)  
 Trefferlage: 2.60 mm links, 3.37 mm tief  
 Streuwert: 8.84, horizontal: 7.95, vertikal: 9.64

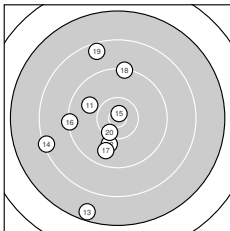

**Serie 2:**

9.9 ↖	10.0 ↓	7.5 ↓	8.3 ←	10.8 *
9.3 ←	9.8 ↓	9.3 ↑	8.5 ↑	10.4 *

beste Teiler: 134.1 (15.), 450.4 (20.), 752.3 (12.)  
 Trefferlage: 6.05 mm links, 1.74 mm tief  
 Streuwert: 9.92, horizontal: 6.58, vertikal: 12.39

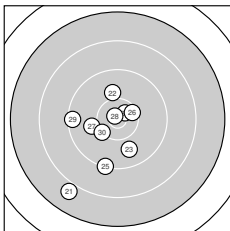

**Serie 3:**

7.9 ↙	10.0 ↑	9.8 ↓	10.6 *	9.3 ↓
10.4 *	10.0 ←	10.8 *	9.4 ←	10.2 ↙

beste Teiler: 116.1 (28.), 269.5 (24.), 447.5 (26.)  
 Trefferlage: 3.36 mm links, 3.53 mm tief  
 Streuwert: 7.21, horizontal: 6.15, vertikal: 8.14



Ergebnis: **279.7** (265)  
 Serien: 87.4 97.1 95.2  
 Zähler: 10 10 6 3 1 0 0 0 0 0  
 Innenzehner: 3  
 Weitesten: 3975 (4.), 2742 (2.), 2489 (29.)  
 beste Teiler: 143.0 (20.), 268.1 (16.), 393.9 (11.)  
 Trefferlage: 4.46 mm rechts, 3.70 mm tief  
 Streuwert: 10.37, horizontal: 6.06, vertikal: 13.36

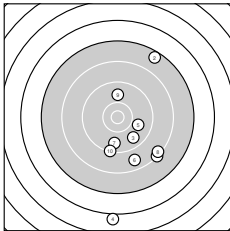
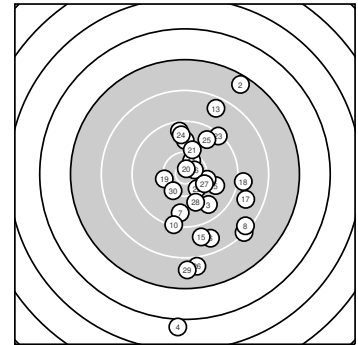

**Serie 1:**  
 8.3 ↘                      7.5 ↗                      9.7 ↘                      6.0 ↓                      9.9 →  
 8.7 ↘                      9.7 ↓                      8.4 ↘                      9.9 ↑                      9.3 ↓  
 beste Teiler: 853.0 (5.), 877.0 (9.), 997.3 (3.)  
 Trefferlage: 6.03 mm rechts, 8.69 mm tief  
 Streuwert: 12.83, horizontal: 7.36, vertikal: 16.58

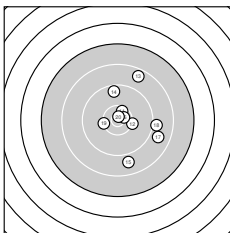

**Serie 2:**  
 10.5 \*                      10.2 →                      8.6 ↗                      9.5 ↑                      8.8 ↓  
 10.6 \*                      8.8 →                      9.0 →                      10.3 ←                      10.8 \*  
 beste Teiler: 143.0 (20.), 268.1 (16.), 393.9 (11.)  
 Trefferlage: 4.67 mm rechts, 0.69 mm hoch  
 Streuwert: 8.04, horizontal: 6.81, vertikal: 9.10

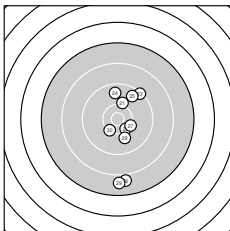

**Serie 3:**  
 10.1 ↗                      10.3 ↘                      9.3 ↗                      9.7 ↑                      9.6 ↗  
 7.9 ↓                      10.2 →                      10.0 ↓                      7.8 ↓                      10.3 ↘  
 beste Teiler: 489.7 (22.), 530.3 (30.), 563.9 (27.)  
 Trefferlage: 2.68 mm rechts, 3.12 mm tief  
 Streuwert: 9.47, horizontal: 3.38, vertikal: 12.95



Ergebnis: **294.8** (284)  
 Serien: 97.6 100.6 96.6  
 Zähler: 16 12 2 0 0 0 0 0 0  
 Innenzehner: 5  
 Weitestе: 1998 (7.), 1641 (27.), 1586 (2.)  
 beste Teiler: 53.7 (17.), 207.3 (24.), 237.1 (10.)  
 Trefferlage: 0.62 mm rechts, 0.32 mm hoch  
 Streuwert: 7.27, horizontal: 4.90, vertikal: 9.04

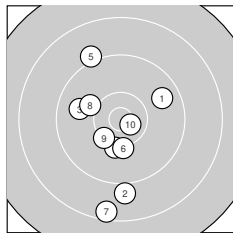
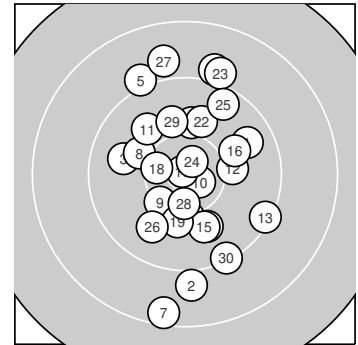

**Serie 1:**  
 9.7 ↗                      9.0 ↓                      9.8 ←                      10.2 ↓                      9.1 ↖  
 10.2 ↓                      8.5 ↓                      10.1 ↖                      10.3 ↙                      10.7 \*  
 beste Teiler: 237.1 (10.), 534.0 (9.), 618.5 (4.)  
 Trefferlage: 1.69 mm links, 2.98 mm tief  
 Streuwert: 7.81, horizontal: 5.15, vertikal: 9.77

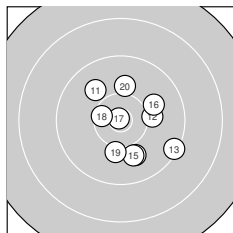

**Serie 2:**  
 9.9 ↘                      10.1 →                      9.3 ↘                      9.9 ↓                      10.0 ↓  
 10.0 ↗                      10.9 \*                      10.4 \*                      10.1 ↓                      10.0 ↑  
 beste Teiler: 53.7 (17.), 411.5 (18.), 683.3 (12.)  
 Trefferlage: 2.13 mm rechts, 0.87 mm tief  
 Streuwert: 5.49, horizontal: 5.24, vertikal: 5.74

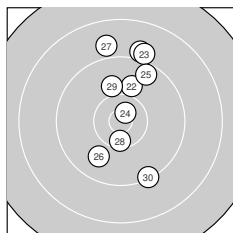

**Serie 3:**  
 9.0 ↑                      10.0 ↑                      9.0 ↑                      10.7 \*                      9.5 ↗  
 9.8 ↙                      8.9 ↑                      10.4 \*                      10.0 ↑                      9.3 ↓  
 beste Teiler: 207.3 (24.), 420.2 (28.), 769.8 (29.)  
 Trefferlage: 1.43 mm rechts, 4.84 mm hoch  
 Streuwert: 7.51, horizontal: 3.78, vertikal: 9.92





Ergebnis: **295.8** (285)  
 Serien: 103.4 97.8 94.6  
 Zähler: 18 9 3 0 0 0 0 0 0 0  
 Innenzehner: 6  
 Weitester: 2268 (22.), 2050 (29.), 1607 (23.)  
 beste Teiler: 122.0 (3.), 197.1 (8.), 244.2 (5.)  
 Trefferlage: 3.36 mm rechts, 2.19 mm tief  
 Streuwert: 6.58, horizontal: 4.02, vertikal: 8.39

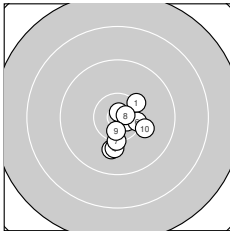
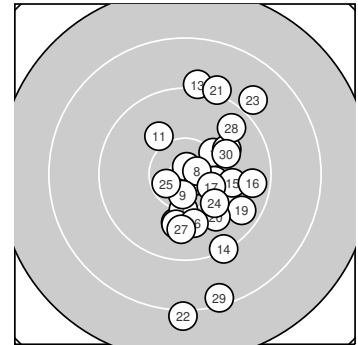

**Serie 1:**

10.2 ↗	10.0 ↓	10.8 *	10.0 ↓	10.6 *
10.3 →	10.2 ↓	10.7 *	10.5 *	10.1 →
beste Teiler: 122.0 (3.), 197.1 (8.), 244.2 (5.)				
Trefferlage: 1.72 mm rechts, 2.36 mm tief				
Streuwert: 3.26, horizontal: 2.72, vertikal: 3.71				

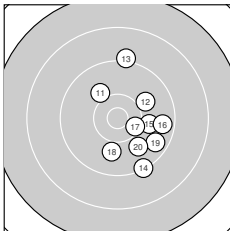

**Serie 2:**

10.0 ↘	10.0 ↗	9.1 ↑	9.3 ↘	10.0 →
9.6 →	10.4 *	9.9 ↓	9.6 ↘	9.9 ↘
beste Teiler: 465.6 (17.), 735.0 (11.), 769.6 (15.)				
Trefferlage: 4.58 mm rechts, 1.30 mm tief				
Streuwert: 6.37, horizontal: 4.64, vertikal: 7.72				

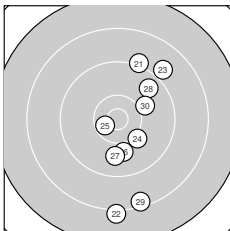

**Serie 3:**

9.2 ↑	8.1 ↓	8.9 ↗	10.1 ↘	10.5 *
10.0 ↓	9.8 ↓	9.6 ↗	8.4 ↓	10.0 →
beste Teiler: 335.4 (25.), 664.7 (24.), 734.7 (30.)				
Trefferlage: 3.77 mm rechts, 2.93 mm tief				
Streuwert: 9.23, horizontal: 4.28, vertikal: 12.33				



Ergebnis: **270.6** (257)  
 Serien: 87.9 90.7 92.0  
 Zähler: 5 12 8 5 0 0 0 0 0 0  
 Innenzehner: 2  
 Weitestе: 3144 (28.), 2772 (7.), 2695 (15.)  
 beste Teiler: 144.0 (10.), 288.1 (19.), 529.0 (30.)  
 Trefferlage: 8.83 mm rechts, 3.96 mm tief  
 Streuwert: 10.16, horizontal: 7.54, vertikal: 12.23

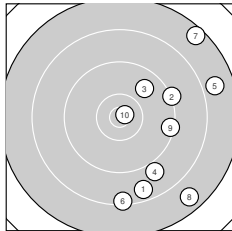
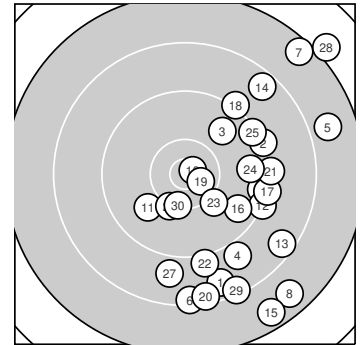

**Serie 1:**

8.6 ↓	9.2 →	9.8 ↗	8.9 ↓	7.8 →
8.3 ↓	7.5 ↗	7.7 ↓	9.3 →	10.8 *

beste Teiler: 144.0 (10.), 944.2 (3.), 1286.7 (9.)  
 Trefferlage: 10.83 mm rechts, 3.34 mm tief  
 Streuwert: 11.29, horizontal: 7.61, vertikal: 14.04

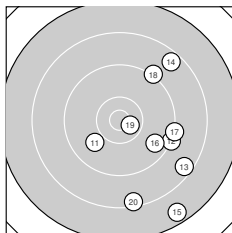

**Serie 2:**

9.9 ↖	9.2 →	8.5 ↘	8.5 ↗	7.6 ↓
9.6 ↘	9.2 →	9.2 ↗	10.6 *	8.4 ↓

beste Teiler: 288.1 (19.), 825.0 (11.), 1046.7 (16.)  
 Trefferlage: 8.66 mm rechts, 4.91 mm tief  
 Streuwert: 9.69, horizontal: 6.90, vertikal: 11.84

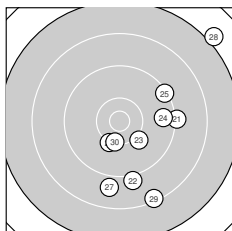

**Serie 3:**

9.2 →	9.1 ↓	10.1 ↘	9.6 →	9.3 ↗
10.2 ↓	8.9 ↓	7.0 ↗	8.3 ↓	10.3 ↓

beste Teiler: 529.0 (30.), 589.4 (26.), 670.3 (23.)  
 Trefferlage: 6.99 mm rechts, 3.62 mm tief  
 Streuwert: 10.32, horizontal: 8.33, vertikal: 11.98



Ergebnis: **293.8** (279)  
 Serien: 99.1 95.7 99.0  
 Zähler: 12 15 3 0 0 0 0 0 0 0  
 Innenzehner: 5  
 Weitester: 2299 (28.), 1989 (12.), 1753 (18.)  
 beste Teiler: 256.1 (25.), 312.5 (23.), 321.0 (30.)  
 Trefferlage: 0.76 mm rechts, 3.13 mm tief  
 Streuwert: 7.14, horizontal: 5.55, vertikal: 8.44

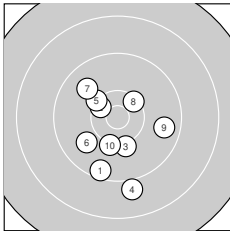
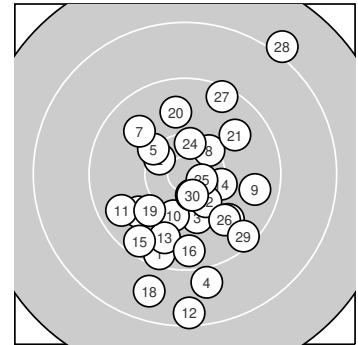

**Serie 1:**

9.5 ↓	10.4 *	10.1 ↓	9.0 ↓	10.2 ↖
9.9 ↙	9.8 ↘	10.3 ↗	9.7 →	10.2 ↓

beste Teiler: 424.1 (2.), 482.9 (8.), 578.6 (5.)  
 Trefferlage: 0.83 mm links, 3.14 mm tief  
 Streuwert: 6.25, horizontal: 5.33, vertikal: 7.05

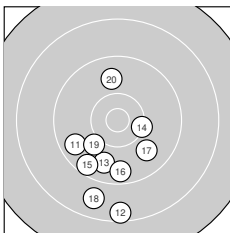

**Serie 2:**

9.6 ↙	8.5 ↓	9.8 ↓	10.3 →	9.5 ↙
9.6 ↓	9.8 ↘	8.8 ↓	10.0 ↙	9.8 ↑

beste Teiler: 541.4 (14.), 727.7 (19.), 898.6 (20.)  
 Trefferlage: 1.73 mm links, 7.58 mm tief  
 Streuwert: 6.67, horizontal: 4.99, vertikal: 8.00

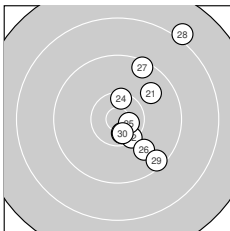

**Serie 3:**

9.8 ↗	10.3 ↘	10.6 *	10.4 *	10.6 *
9.9 ↘	9.4 ↗	8.1 ↗	9.4 ↘	10.5 *

beste Teiler: 256.1 (25.), 312.5 (23.), 321.0 (30.)  
 Trefferlage: 4.86 mm rechts, 1.31 mm hoch  
 Streuwert: 6.69, horizontal: 4.18, vertikal: 8.48



**Ergebnis: 270.2 (256)**  
**Serien: 92.8 91.1 86.3**  
**Zähler: 6 11 7 5 1 0 0 0 0 0**  
**Innenzehner: 2**  
**Weiteste: 3347 (17.), 2828 (8.), 2787 (23.)**  
**beste Teiler: 393.2 (22.), 452.9 (13.), 619.8 (7.)**  
**Trefferlage: 0.58 mm rechts, 3.97 mm tief**  
**Streuwert: 12.35, horizontal: 8.62, vertikal: 15.19**

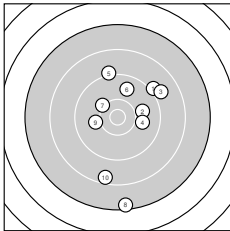
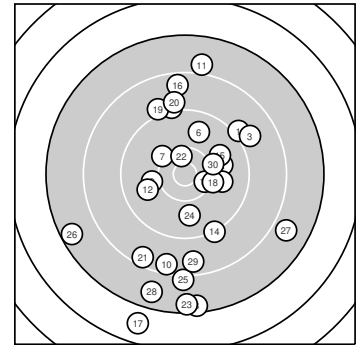

**Serie 1:**

9.1 ↗	9.9 →	8.9 ↗	9.9 →	9.1 ↑
9.8 ↑	10.2 ↘	7.4 ↓	10.0 ←	8.5 ↓

**beste Teiler: 619.8 (7.), 724.2 (9.), 813.8 (4.)**  
**Trefferlage: 2.81 mm rechts, 0.41 mm tief**  
**Streuwert: 10.82, horizontal: 7.35, vertikal: 13.43**

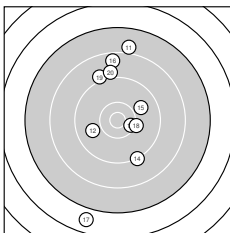

**Serie 2:**

8.0 ↑	9.9 ←	10.4 *	9.2 ↘	9.9 ↗
8.6 ↑	6.8 ↓	10.2 →	9.1 ↑	9.0 ↑

**beste Teiler: 452.9 (13.), 623.2 (18.), 851.4 (15.)**  
**Trefferlage: 0.01 mm links, 2.49 mm hoch**  
**Streuwert: 12.59, horizontal: 6.41, vertikal: 16.61**

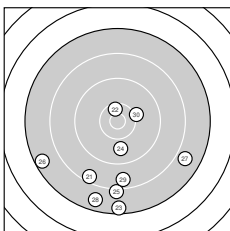

**Serie 3:**

8.5 ↓	10.5 *	7.5 ↓	9.8 ↓	8.1 ↓
7.5 ←	7.9 ↘	7.7 ↓	8.6 ↓	10.2 →

**beste Teiler: 393.2 (22.), 639.8 (30.), 886.5 (24.)**  
**Trefferlage: 1.06 mm links, 13.98 mm tief**  
**Streuwert: 11.20, horizontal: 11.63, vertikal: 10.75**



Ergebnis: **288.7** (276)  
 Serien: 99.7 94.5 94.5  
 Zähler: 12 14 2 2 0 0 0 0 0 0  
 Innenzehner: 6  
 Weitestе: 2617 (13.), 2430 (23.), 2324 (9.)  
 beste Teiler: 213.0 (20.), 242.2 (6.), 353.3 (12.)  
 Trefferlage: 2.27 mm links, 2.53 mm hoch  
 Streuwert: 8.58, horizontal: 6.92, vertikal: 9.97

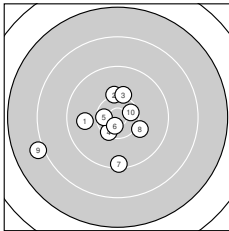
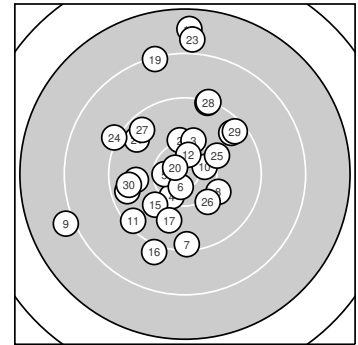

**Serie 1:**

9.8 ←	10.2 ↑	10.2 ↑	10.4 *	10.5 *
10.6 *	9.4 ↓	10.1 ↘	8.0 ←	10.5 *

beste Teiler: 242.2 (6.), 369.0 (5.), 378.3 (10.)  
 Trefferlage: 2.66 mm links, 1.86 mm tief  
 Streuwert: 6.88, horizontal: 7.75, vertikal: 5.90

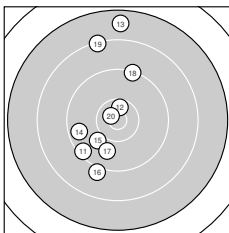

**Serie 2:**

9.4 ↙	10.5 *	7.7 ↑	9.6 ←	10.0 ↙
9.1 ↓	9.9 ↓	9.3 ↑	8.3 ↑	10.7 *

beste Teiler: 213.0 (20.), 353.3 (12.), 770.0 (15.)  
 Trefferlage: 3.52 mm links, 2.50 mm hoch  
 Streuwert: 9.99, horizontal: 4.58, vertikal: 13.36

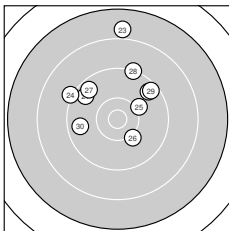

**Serie 3:**

9.6 ↘	9.6 ↗	7.9 ↑	9.2 ↘	10.1 ↗
10.1 ↘	9.6 ↘	9.2 ↑	9.5 ↗	9.7 ←

beste Teiler: 646.6 (26.), 667.0 (25.), 1028.2 (30.)  
 Trefferlage: 0.65 mm links, 6.96 mm hoch  
 Streuwert: 8.13, horizontal: 8.27, vertikal: 7.98

