

**Ergebnis:** **410.6** (391)  
**Serien:** 102.1 103.7 101.8 103.0  
**Zähler:** 32 7 1 0 0 0 0 0 0  
**Innenzehner:** 28  
**Weiteste:** 661 (23.), 325 (33.), 324 (7.)  
**beste Teiler:** 36.2 (20.), 49.6 (21.), 56.0 (26.)  
**Trefferlage:** 0.64 mm links, 0.28 mm tief  
**Streuwert:** 1.39, horizontal: 1.50, vertikal: 1.27

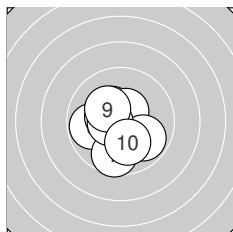

**Serie 1:**  
 10.5 \*                      10.4 \*                      9.8 ←                      10.4 \*                      10.5 \*  
 9.9 ↘                      9.7 ↓                      10.5 \*                      10.3 \*                      10.1 ↓  
**beste Teiler:** 102.1 (8.), 108.7 (5.), 113.8 (1.)  
**Trefferlage:** 0.51 mm links, 0.29 mm tief  
**Streuwert:** 1.44, horizontal: 1.35, vertikal: 1.53

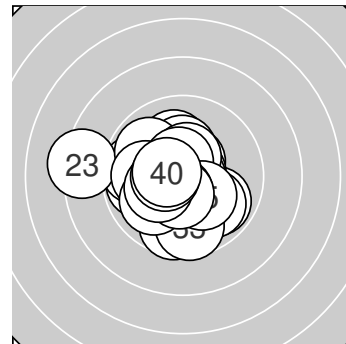
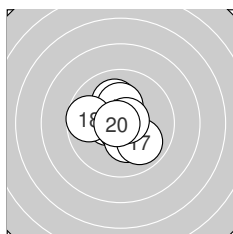

**Serie 2:**  
 10.5 \*                      10.7 \*                      10.7 \*                      10.1 ↑                      10.3 \*  
 10.3 \*                      9.9 ↘                      9.7 ←                      10.7 \*                      10.8 \*  
**beste Teiler:** 36.2 (20.), 57.7 (13.), 60.4 (19.)  
**Trefferlage:** 0.19 mm links, 0.11 mm hoch  
**Streuwert:** 1.27, horizontal: 1.30, vertikal: 1.23

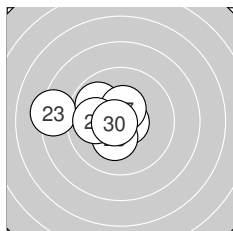

**Serie 3:**  
 10.8 \*                      10.4 \*                      8.3 ←                      10.2 \*                      9.9 ↘  
 10.7 \*                      10.5 \*                      10.3 \*                      10.0 ←                      10.7 \*  
**beste Teiler:** 49.6 (21.), 56.0 (26.), 62.0 (30.)  
**Trefferlage:** 1.42 mm links, 0.01 mm hoch  
**Streuwert:** 1.62, horizontal: 2.07, vertikal: 1.00

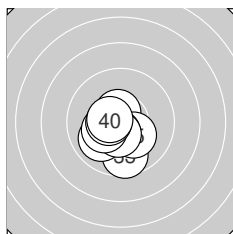

**Serie 4:**  
 10.2 \*                      10.6 \*                      9.7 ↓                      10.0 ↙                      10.2 \*  
 10.5 \*                      10.5 \*                      10.3 \*                      10.5 \*                      10.5 \*  
**beste Teiler:** 97.8 (32.), 107.0 (36.), 107.9 (40.)  
**Trefferlage:** 0.45 mm links, 0.97 mm tief  
**Streuwert:** 1.08, horizontal: 0.97, vertikal: 1.18



Ergebnis: **397.1** (383)  
 Serien: 99.2 98.3 99.9 99.7  
 Zähler: 23 17 0 0 0 0 0 0 0  
 Innenzehner: 11  
 Weitestе: 463 (22.), 428 (9.), 380 (19.)  
 beste Teiler: 72.4 (39.), 79.5 (25.), 112.0 (30.)  
 Trefferlage: 0.44 mm links, 0.31 mm tief  
 Streuwert: 1.90, horizontal: 2.04, vertikal: 1.76

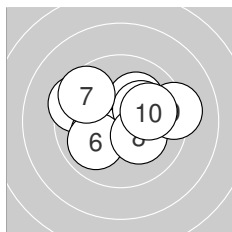
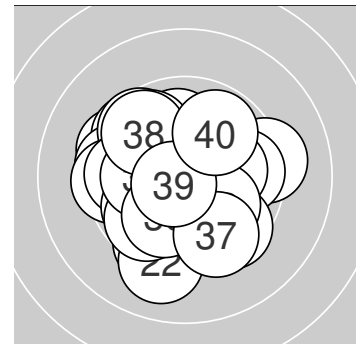

**Serie 1:**  
 9.5 ↖                      10.2 \*                      10.1 ↗                      10.2 \*                      10.2 \*  
 10.0 ↙                      9.6 ↘                      10.2 \*                      9.2 →                      10.0 →  
 beste Teiler: 183.0 (8.), 187.4 (5.), 191.0 (2.)  
 Trefferlage: 0.07 mm links, 0.29 mm hoch  
 Streuwert: 2.02, horizontal: 2.52, vertikal: 1.34

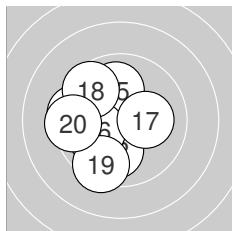

**Serie 2:**  
 10.0 ↘                      10.0 ↓                      10.0 ↙                      9.5 ←                      10.0 ↑  
 10.2 \*                      10.2 \*                      9.6 ↘                      9.4 ↓                      9.4 ←  
 beste Teiler: 197.0 (17.), 199.7 (16.), 229.2 (13.)  
 Trefferlage: 1.48 mm links, 0.06 mm tief  
 Streuwert: 1.84, horizontal: 1.67, vertikal: 1.99

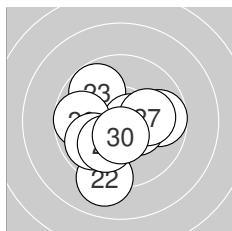

**Serie 3:**  
 9.7 →                      9.1 ↓                      9.8 ↘                      10.4 \*                      10.6 \*  
 9.7 ←                      10.1 →                      9.9 ↙                      10.1 ↓                      10.5 \*  
 beste Teiler: 79.5 (25.), 112.0 (30.), 133.8 (24.)  
 Trefferlage: 0.23 mm links, 0.65 mm tief  
 Streuwert: 1.88, horizontal: 1.99, vertikal: 1.77

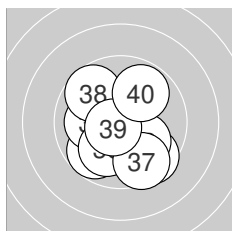

**Serie 4:**  
 10.5 \*                      9.5 ↘                      10.0 ↘                      9.8 ↙                      10.1 ←  
 10.0 ↓                      9.6 ↘                      9.7 ↘                      10.7 \*                      9.8 ↗  
 beste Teiler: 72.4 (39.), 121.2 (31.), 221.0 (35.)  
 Trefferlage: 0.00 mm , 0.83 mm tief  
 Streuwert: 1.85, horizontal: 1.81, vertikal: 1.90



Ergebnis: **402.8** (386)  
 Serien: 100.6 97.8 101.8 102.6  
 Zähler: 28 10 2 0 0 0 0 0 0 0  
 Innenzehner: 20  
 Weitester: 665 (20.), 573 (6.), 497 (19.)  
 beste Teiler: 30.4 (35.), 34.7 (7.), 43.4 (12.)  
 Trefferlage: 0.25 mm rechts, 0.13 mm tief  
 Streuwert: 1.89, horizontal: 1.91, vertikal: 1.87

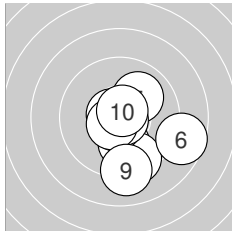
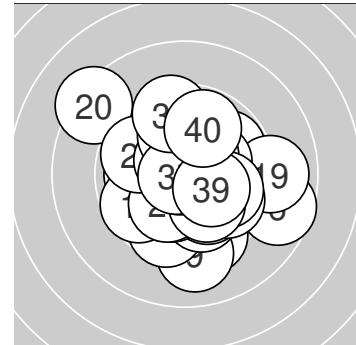

**Serie 1:**

10.0 ↓	9.4 ↓	10.7 *	10.6 *	10.0 ↗
8.7 ↘	10.8 *	10.6 *	9.1 ↓	10.7 *

beste Teiler: 34.7 (7.), 60.5 (10.), 71.5 (3.)  
 Trefferlage: 0.82 mm rechts, 1.12 mm tief  
 Streuwert: 1.86, horizontal: 1.78, vertikal: 1.94

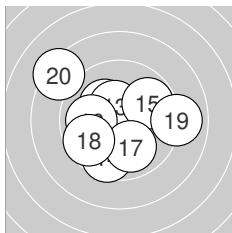

**Serie 2:**

10.2 *	10.8 *	10.4 *	9.6 ↓	9.8 ↗
10.0 ←	10.0 ↓	9.7 ↙	9.0 →	8.3 ↘

beste Teiler: 43.4 (12.), 130.2 (13.), 186.0 (11.)  
 Trefferlage: 0.50 mm links, 0.04 mm hoch  
 Streuwert: 2.51, horizontal: 2.86, vertikal: 2.11

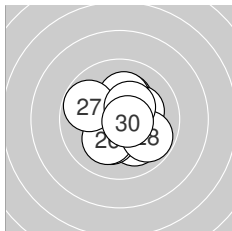

**Serie 3:**

10.2 *	10.2 *	10.1 ↓	10.2 *	10.2 *
10.2 *	9.8 ↖	9.8 ↘	10.4 *	10.7 *

beste Teiler: 72.8 (30.), 138.4 (29.), 180.5 (22.)  
 Trefferlage: 0.34 mm rechts, 0.04 mm tief  
 Streuwert: 1.50, horizontal: 1.47, vertikal: 1.53

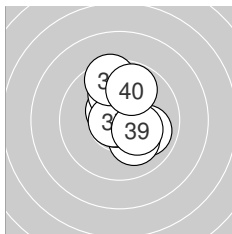

**Serie 4:**

10.8 *	10.0 ↘	10.1 ↓	10.5 *	10.8 *
10.0 ↑	10.8 *	9.5 ↑	10.3 *	9.8 ↗

beste Teiler: 30.4 (35.), 44.4 (31.), 49.8 (37.)  
 Trefferlage: 0.35 mm rechts, 0.59 mm hoch  
 Streuwert: 1.44, horizontal: 1.11, vertikal: 1.70



Ergebnis: **376.6** (357)  
 Serien: 96.4 92.2 97.2 90.8  
 Zähler: 8 21 11 0 0 0 0 0 0  
 Innenzehner: 6  
 Weitester: 685 (36.), 650 (17.), 641 (37.)  
 beste Teiler: 131.6 (28.), 141.4 (22.), 151.3 (40.)  
 Trefferlage: 0.75 mm rechts, 0.31 mm hoch  
 Streuwert: 2.91, horizontal: 3.13, vertikal: 2.67

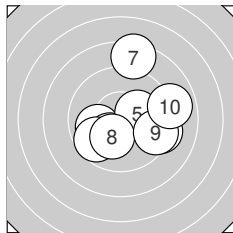
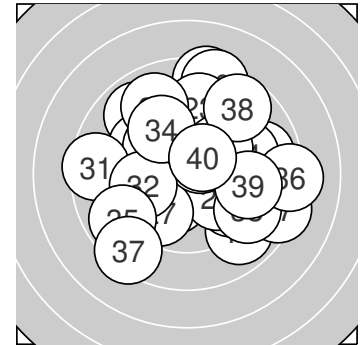

**Serie 1:**  
 9.3 → 10.0 ← 10.1 → 10.2 \* 10.2 \*  
 9.7 ↙ 8.4 ↑ 10.2 \* 9.4 → 8.9 →  
 beste Teiler: 179.9 (5.), 192.3 (8.), 194.9 (4.)  
 Trefferlage: 1.09 mm rechts, 0.01 mm tief  
 Streuwert: 2.56, horizontal: 2.64, vertikal: 2.47

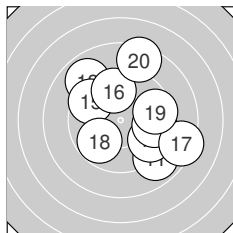

**Serie 2:**  
 8.9 ↘ 9.5 ↘ 8.9 ↘ 9.6 → 9.5 ↘  
 9.7 ↑ 8.4 → 9.8 ↙ 9.5 → 8.4 ↑  
 beste Teiler: 294.1 (18.), 303.9 (16.), 341.3 (14.)  
 Trefferlage: 1.21 mm rechts, 0.50 mm hoch  
 Streuwert: 3.21, horizontal: 3.24, vertikal: 3.17

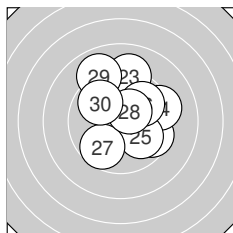

**Serie 3:**  
 9.6 → 10.4 \* 9.1 ↑ 9.3 → 9.9 ↘  
 9.9 ↗ 9.7 ↙ 10.4 \* 9.0 ↘ 9.9 ↘  
 beste Teiler: 131.6 (28.), 141.4 (22.), 252.4 (25.)  
 Trefferlage: 0.65 mm rechts, 1.08 mm hoch  
 Streuwert: 2.27, horizontal: 2.18, vertikal: 2.37

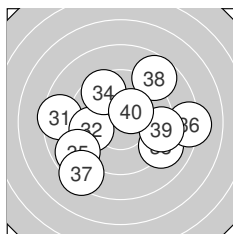

**Serie 4:**  
 8.5 ← 9.8 ← 9.1 ↘ 9.6 ↘ 8.9 ↙  
 8.2 → 8.4 ↙ 8.7 ↗ 9.3 → 10.3 \*  
 beste Teiler: 151.3 (40.), 300.9 (32.), 344.3 (34.)  
 Trefferlage: 0.04 mm rechts, 0.30 mm tief  
 Streuwert: 3.69, horizontal: 4.40, vertikal: 2.80



**Ergebnis:** **413.8** (396)  
**Serien:** 103.7 103.2 103.3 103.6  
**Zähler:** 36 4 0 0 0 0 0 0 0 0  
**Innenzehner:** 32  
**Weiteste:** 374 (21.), 343 (13.), 261 (2.)  
**beste Teiler:** 24.3 (8.), 29.0 (28.), 37.2 (10.)  
**Trefferlage:** 0.00 mm , 0.08 mm hoch  
**Streuwert:** 1.22, horizontal: 1.32, vertikal: 1.10

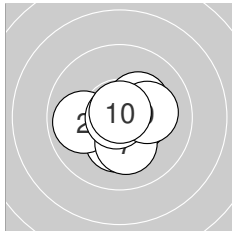
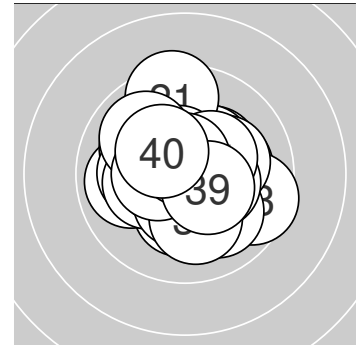

**Serie 1:**

10.3 *	9.9 ←	10.3 *	10.5 *	10.3 *
10.4 *	10.2 *	10.9 *	10.1 →	10.8 *

**beste Teiler:** 24.3 (8.), 37.2 (10.), 114.5 (4.)  
**Trefferlage:** 0.46 mm rechts, 0.15 mm tief  
**Streuwert:** 1.17, horizontal: 1.32, vertikal: 0.99

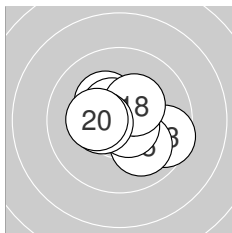

**Serie 2:**

10.5 *	10.6 *	9.6 ↘	10.3 *	10.0 ↘
10.6 *	10.6 *	10.3 *	10.4 *	10.3 *

**beste Teiler:** 77.6 (17.), 78.5 (12.), 97.9 (16.)  
**Trefferlage:** 0.00 mm , 0.03 mm tief  
**Streuwert:** 1.30, horizontal: 1.57, vertikal: 0.96

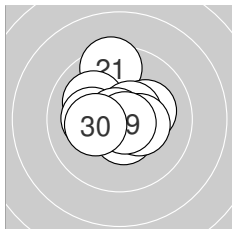

**Serie 3:**

9.5 ↑	10.1 ↖	10.2 *	10.6 *	10.5 *
10.4 *	10.2 *	10.8 *	10.8 *	10.2 *

**beste Teiler:** 29.0 (28.), 47.4 (29.), 93.1 (24.)  
**Trefferlage:** 0.17 mm links, 0.40 mm hoch  
**Streuwert:** 1.34, horizontal: 1.37, vertikal: 1.32

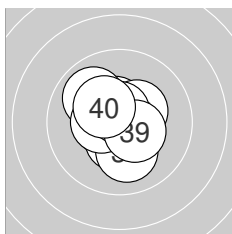

**Serie 4:**

10.5 *	9.9 ↖	10.5 *	10.4 *	10.4 *
10.1 ↓	10.4 *	10.7 *	10.4 *	10.3 *

**beste Teiler:** 70.2 (38.), 110.7 (31.), 112.5 (33.)  
**Trefferlage:** 0.31 mm links, 0.12 mm hoch  
**Streuwert:** 1.12, horizontal: 1.05, vertikal: 1.19



Ergebnis: **412.0** (392)  
 Serien: 103.2 104.2 102.6 102.0  
 Zähler: 33 6 1 0 0 0 0 0 0  
 Innenzehner: 29  
 Weitester: 531 (37.), 409 (34.), 300 (21.)  
 beste Teiler: 7.2 (35.), 23.7 (17.), 30.4 (36.)  
 Trefferlage: 0.28 mm rechts, 0.07 mm hoch  
 Streuwert: 1.37, horizontal: 1.28, vertikal: 1.45

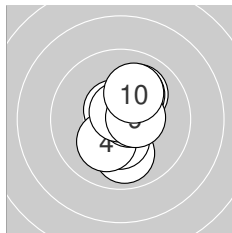
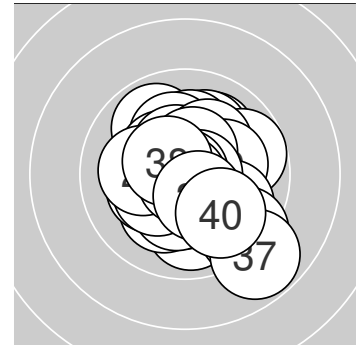

**Serie 1:**  
 9.9 ↓                      10.6 \*                      10.4 \*                      10.2 \*                      10.7 \*  
 10.7 \*                      10.0 ↗                      10.1 ↗                      10.5 \*                      10.1 ↗  
 beste Teiler: 56.0 (6.), 68.6 (5.), 87.8 (2.)  
 Trefferlage: 0.36 mm rechts, 0.14 mm hoch  
 Streuwert: 1.26, horizontal: 0.79, vertikal: 1.59

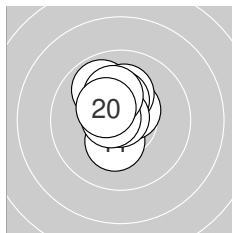

**Serie 2:**  
 10.3 \*                      10.5 \*                      9.9 ↘                      10.2 \*                      10.7 \*  
 10.4 \*                      10.9 \*                      10.7 \*                      10.2 \*                      10.4 \*  
 beste Teiler: 23.7 (17.), 71.1 (15.), 74.2 (18.)  
 Trefferlage: 0.40 mm links, 0.84 mm hoch  
 Streuwert: 0.93, horizontal: 0.64, vertikal: 1.14

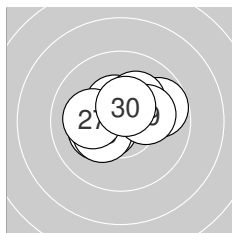

**Serie 3:**  
 9.8 →                      10.5 \*                      10.4 \*                      10.4 \*                      10.2 \*  
 10.3 \*                      10.1 ←                      10.2 \*                      10.2 \*                      10.5 \*  
 beste Teiler: 107.7 (22.), 117.3 (30.), 127.5 (24.)  
 Trefferlage: 0.05 mm rechts, 0.44 mm hoch  
 Streuwert: 1.30, horizontal: 1.63, vertikal: 0.86

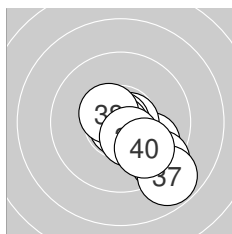

**Serie 4:**  
 9.9 ↘                      10.8 \*                      10.7 \*                      9.3 ↘                      10.9 \*  
 10.8 \*                      8.8 ↘                      10.5 \*                      10.4 \*                      9.9 ↘  
 beste Teiler: 7.2 (35.), 30.4 (36.), 45.2 (32.)  
 Trefferlage: 1.10 mm rechts, 1.12 mm tief  
 Streuwert: 1.45, horizontal: 1.44, vertikal: 1.46



**Ergebnis:** **393.4** (375)  
**Serien:** 99.1 98.7 98.4 97.2  
**Zähler:** 20 15 5 0 0 0 0 0 0 0  
**Innenzehner:** 15  
**Weiteste:** 736 (40.), 613 (38.), 553 (18.)  
**beste Teiler:** 4.0 (13.), 39.6 (1.), 51.4 (25.)  
**Trefferlage:** 0.54 mm rechts, 0.61 mm hoch  
**Streuwert:** 2.27, horizontal: 2.43, vertikal: 2.10

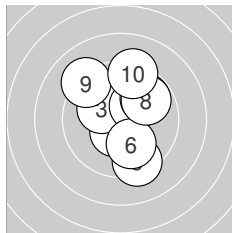
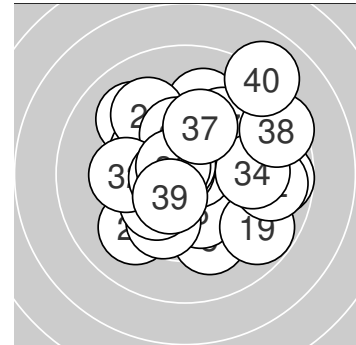

**Serie 1:**  
 10.8 \*                      10.5 \*                      10.2 \*                      10.3 \*                      9.3 ↘  
 10.0 ↘                      9.8 ↗                      9.8 ↗                      9.1 ↘                      9.3 ↑  
**beste Teiler:** 39.6 (1.), 124.8 (2.), 172.5 (4.)  
**Trefferlage:** 0.36 mm rechts, 0.63 mm hoch  
**Streuwert:** 2.12, horizontal: 1.75, vertikal: 2.43

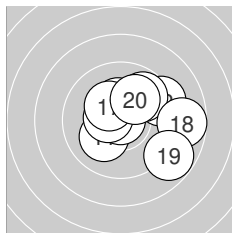

**Serie 2:**  
 10.1 ↗                      9.3 ↗                      10.9 \*                      10.3 \*                      9.8 ↗  
 10.5 \*                      10.3 \*                      8.7 →                      8.8 ↘                      10.0 ↗  
**beste Teiler:** 4.0 (13.), 114.3 (16.), 159.9 (14.)  
**Trefferlage:** 1.29 mm rechts, 0.39 mm hoch  
**Streuwert:** 2.14, horizontal: 2.50, vertikal: 1.70

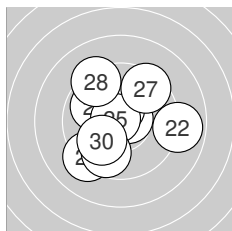

**Serie 3:**  
 10.7 \*                      8.9 →                      10.5 \*                      9.9 ↘                      10.7 \*  
 9.2 ↗                      9.5 ↗                      9.3 ↘                      9.7 ↘                      10.0 ↗  
**beste Teiler:** 51.4 (25.), 71.7 (21.), 113.2 (23.)  
**Trefferlage:** 0.29 mm links, 0.11 mm hoch  
**Streuwert:** 2.37, horizontal: 2.48, vertikal: 2.26

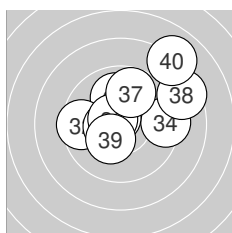

**Serie 4:**  
 10.0 ↑                      9.5 ←                      10.5 \*                      9.3 →                      10.7 \*  
 10.6 \*                      9.8 ↑                      8.5 ↗                      10.3 \*                      8.0 ↗  
**beste Teiler:** 71.0 (35.), 84.5 (36.), 116.1 (33.)  
**Trefferlage:** 0.79 mm rechts, 1.32 mm hoch  
**Streuwert:** 2.55, horizontal: 2.95, vertikal: 2.07



Ergebnis: **405.6** (389)  
 Serien: 101.9 102.4 100.5 100.8  
 Zähler: 30 9 1 0 0 0 0 0 0  
 Innenzehner: 24  
 Weitesten: 533 (30.), 477 (12.), 477 (31.)  
 beste Teiler: 31.9 (28.), 36.8 (4.), 70.1 (40.)  
 Trefferlage: 0.55 mm rechts, 0.46 mm tief  
 Streuwert: 1.61, horizontal: 1.91, vertikal: 1.24

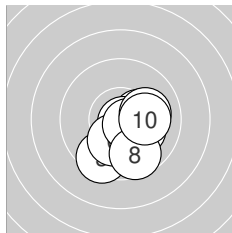
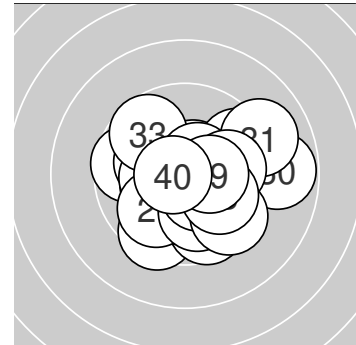

**Serie 1:**  
 10.4 \*                      10.3 \*                      9.5 ↙                      10.8 \*                      10.2 \*  
 10.2 \*                      10.6 \*                      9.7 ↘                      10.1 →                      10.1 →  
 beste Teiler: 36.8 (4.), 80.7 (7.), 136.1 (1.)  
 Trefferlage: 0.82 mm rechts, 0.98 mm tief  
 Streuwert: 1.27, horizontal: 1.21, vertikal: 1.32

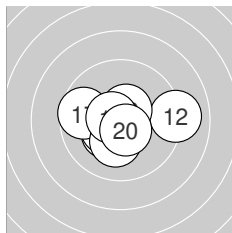

**Serie 2:**  
 10.5 \*                      9.0 →                      10.6 \*                      10.3 \*                      10.4 \*  
 10.5 \*                      9.7 ←                      10.2 \*                      10.6 \*                      10.6 \*  
 beste Teiler: 79.1 (19.), 95.7 (20.), 99.7 (13.)  
 Trefferlage: 0.22 mm links, 0.44 mm tief  
 Streuwert: 1.57, horizontal: 2.03, vertikal: 0.90

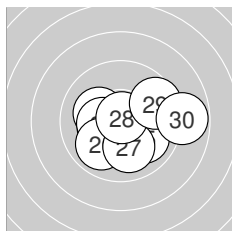

**Serie 3:**  
 10.6 \*                      10.3 \*                      10.2 \*                      10.3 \*                      10.0 ↘  
 9.9 ↙                      10.0 ↓                      10.8 \*                      9.6 →                      8.8 →  
 beste Teiler: 31.9 (28.), 100.4 (21.), 158.1 (24.)  
 Trefferlage: 0.39 mm rechts, 0.44 mm tief  
 Streuwert: 1.89, horizontal: 2.40, vertikal: 1.20

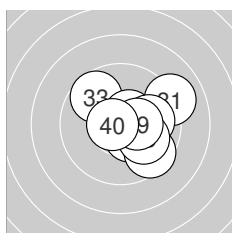

**Serie 4:**  
 9.0 →                      10.5 \*                      9.7 ↘                      10.5 \*                      10.0 →  
 10.4 \*                      9.6 ↘                      10.0 ↘                      10.4 \*                      10.7 \*  
 beste Teiler: 70.1 (40.), 102.5 (34.), 102.8 (32.)  
 Trefferlage: 1.23 mm rechts, 0.03 mm hoch  
 Streuwert: 1.63, horizontal: 1.79, vertikal: 1.46





**Ergebnis:** **415.3** (398)  
**Serien:** 103.1 103.8 104.1 104.3  
**Zähler:** 38 2 0 0 0 0 0 0 0  
**Innenzehner:** 32  
**Weiteste:** 300 (15.), 274 (1.), 246 (2.)  
**beste Teiler:** 29.1 (19.), 29.1 (36.), 48.5 (39.)  
**Trefferlage:** 0.12 mm links, 0.14 mm hoch  
**Streuwert:** 1.13, horizontal: 1.19, vertikal: 1.06

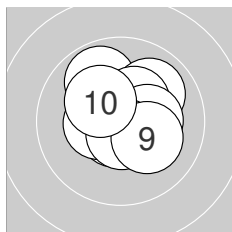
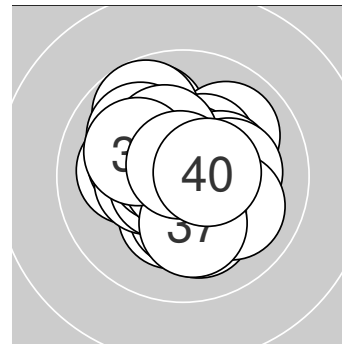

**Serie 1:**  
 9.9 ↘                      10.0 ↗                      10.4 \*                      10.4 \*                      10.3 \*  
 10.7 \*                      10.4 \*                      10.6 \*                      10.2 \*                      10.2 \*  
**beste Teiler:** 72.2 (6.), 77.4 (8.), 132.4 (3.)  
**Trefferlage:** 0.06 mm rechts, 0.46 mm hoch  
**Streuwert:** 1.24, horizontal: 1.33, vertikal: 1.15

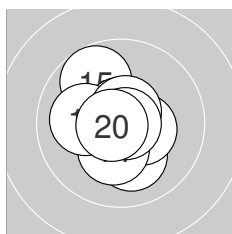

**Serie 2:**  
 10.1 ↓                      10.4 \*                      10.3 \*                      10.3 \*                      9.8 ↘  
 10.7 \*                      10.1 ←                      10.6 \*                      10.8 \*                      10.7 \*  
**beste Teiler:** 29.1 (19.), 55.5 (20.), 63.0 (16.)  
**Trefferlage:** 0.37 mm links, 0.02 mm hoch  
**Streuwert:** 1.19, horizontal: 1.10, vertikal: 1.26

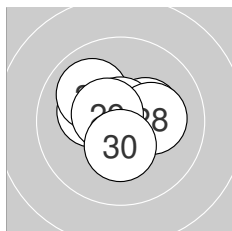

**Serie 3:**  
 10.7 \*                      10.2 \*                      10.4 \*                      10.7 \*                      10.3 \*  
 10.0 ↘                      10.7 \*                      10.2 \*                      10.6 \*                      10.3 \*  
**beste Teiler:** 51.0 (27.), 63.7 (24.), 66.4 (21.)  
**Trefferlage:** 0.10 mm rechts, 0.13 mm hoch  
**Streuwert:** 1.09, horizontal: 1.29, vertikal: 0.86

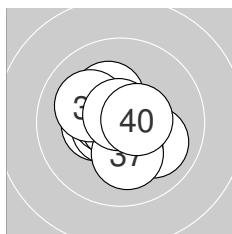

**Serie 4:**  
 10.0 ↘                      10.4 \*                      10.3 \*                      10.6 \*                      10.6 \*  
 10.8 \*                      10.2 \*                      10.1 ↘                      10.8 \*                      10.5 \*  
**beste Teiler:** 29.1 (36.), 48.5 (39.), 89.5 (34.)  
**Trefferlage:** 0.27 mm links, 0.02 mm tief  
**Streuwert:** 1.09, horizontal: 1.16, vertikal: 1.02



Ergebnis: **405.5** (385)  
 Serien: 99.2 102.0 99.9 104.4  
 Zähler: 26 13 1 0 0 0 0 0 0 0  
 Innenzehner: 22  
 Weitesten: 518 (29.), 441 (1.), 389 (25.)  
 beste Teiler: 29.9 (18.), 38.5 (31.), 43.5 (34.)  
 Trefferlage: 0.26 mm links, 0.06 mm tief  
 Streuwert: 1.70, horizontal: 1.52, vertikal: 1.86

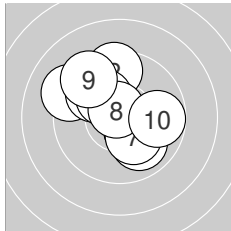
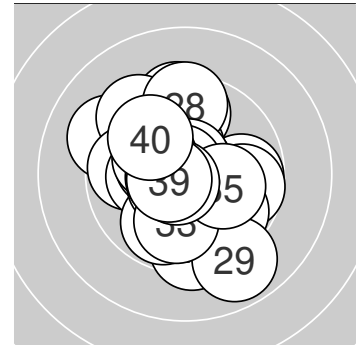

**Serie 1:**

9.2 ↘	9.5 ↑	9.8 ↘	10.4 *	10.0 ↘
10.2 *	10.2 *	10.7 *	9.4 ↘	9.8 →

beste Teiler: 65.0 (8.), 140.7 (4.), 186.6 (7.)  
 Trefferlage: 0.37 mm links, 0.80 mm hoch  
 Streuwert: 2.01, horizontal: 2.10, vertikal: 1.92

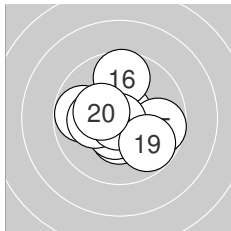

**Serie 2:**

9.8 ←	10.8 *	10.4 *	10.5 *	9.7 →
9.7 ↑	10.2 *	10.8 *	9.8 ↘	10.3 *

beste Teiler: 29.9 (18.), 50.2 (12.), 106.8 (14.)  
 Trefferlage: 0.10 mm links, 0.10 mm tief  
 Streuwert: 1.60, horizontal: 1.77, vertikal: 1.41

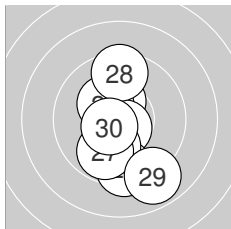

**Serie 3:**

10.4 *	10.3 *	10.3 *	10.6 *	9.4 ↓
10.1 ↓	9.8 ↘	9.5 ↑	8.9 ↘	10.6 *

beste Teiler: 76.5 (24.), 99.6 (30.), 141.9 (21.)  
 Trefferlage: 0.12 mm links, 0.95 mm tief  
 Streuwert: 1.95, horizontal: 1.11, vertikal: 2.52

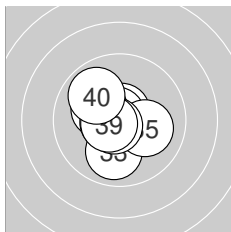

**Serie 4:**

10.8 *	10.7 *	10.0 ↓	10.8 *	10.1 →
10.2 *	10.6 *	10.7 *	10.6 *	9.9 ↘

beste Teiler: 38.5 (31.), 43.5 (34.), 60.8 (38.)  
 Trefferlage: 0.44 mm links, 0.00 mm  
 Streuwert: 1.10, horizontal: 1.06, vertikal: 1.15



Ergebnis: **389.6** (370)  
 Serien: 96.9 98.1 98.1 96.5  
 Zähler: 11 28 1 0 0 0 0 0 0 0  
 Innenzehner: 4  
 Weitest: 634 (3.), 490 (25.), 459 (37.)  
 beste Teiler: 51.4 (2.), 78.7 (29.), 151.8 (32.)  
 Trefferlage: 0.06 mm links, 0.15 mm tief  
 Streuwert: 2.29, horizontal: 2.39, vertikal: 2.19

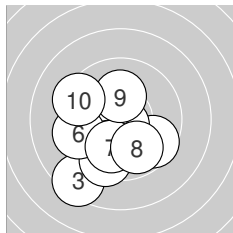
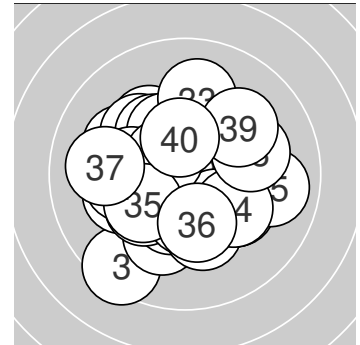

**Serie 1:**  
 9.6 ↘ 10.7 \* 8.4 ↙ 9.9 ↙ 9.5 ↙  
 9.4 ← 10.0 ↓ 9.8 ↘ 10.2 \* 9.4 ↖  
 beste Teiler: 51.4 (2.), 197.0 (9.), 246.9 (7.)  
 Trefferlage: 0.96 mm links, 1.57 mm tief  
 Streuwert: 2.19, horizontal: 2.18, vertikal: 2.20

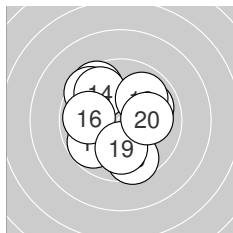

**Serie 2:**  
 9.8 ↙ 9.6 ↘ 9.6 ↘ 9.8 ↘ 9.6 ↓  
 9.9 ← 9.9 → 9.9 ↗ 10.0 ↓ 10.0 →  
 beste Teiler: 226.4 (20.), 237.0 (19.), 255.0 (17.)  
 Trefferlage: 0.39 mm links, 0.33 mm hoch  
 Streuwert: 2.13, horizontal: 2.11, vertikal: 2.16

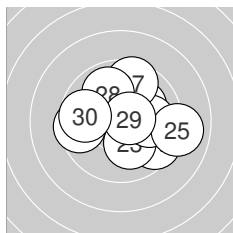

**Serie 3:**  
 9.6 ↘ 10.1 ↗ 10.1 ↓ 10.0 → 9.0 →  
 9.5 ← 9.6 ↑ 9.9 ↘ 10.6 \* 9.7 ←  
 beste Teiler: 78.7 (29.), 202.0 (23.), 212.8 (22.)  
 Trefferlage: 0.68 mm rechts, 0.26 mm hoch  
 Streuwert: 2.19, horizontal: 2.61, vertikal: 1.68

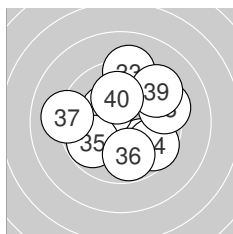

**Serie 4:**  
 9.9 ↘ 10.3 \* 9.2 ↑ 9.6 ↘ 9.8 ↙  
 9.8 ↓ 9.1 ← 9.4 → 9.3 ↗ 10.1 ↑  
 beste Teiler: 151.8 (32.), 211.1 (40.), 264.0 (31.)  
 Trefferlage: 0.42 mm rechts, 0.34 mm hoch  
 Streuwert: 2.48, horizontal: 2.61, vertikal: 2.35



Ergebnis: **402.8** (385)  
 Serien: 101.0 101.9 98.9 101.0  
 Zähler: 25 15 0 0 0 0 0 0 0 0  
 Innenzehner: 18  
 Weitester: 500 (29.), 443 (24.), 432 (34.)  
 beste Teiler: 63.8 (8.), 77.2 (19.), 88.9 (5.)  
 Trefferlage: 0.31 mm rechts, 0.03 mm hoch  
 Streuwert: 1.71, horizontal: 1.86, vertikal: 1.55

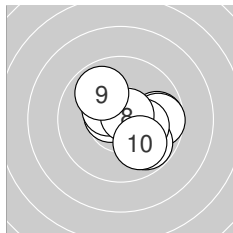
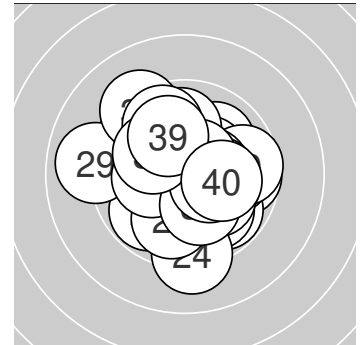

**Serie 1:**

10.1 ↘	9.7 →	9.7 →	9.8 ↘	10.6 *
10.4 *	10.2 *	10.7 *	9.9 ↘	9.9 ↘

beste Teiler: 63.8 (8.), 88.9 (5.), 130.4 (6.)  
 Trefferlage: 1.07 mm rechts, 0.18 mm tief  
 Streuwert: 1.49, horizontal: 1.69, vertikal: 1.26

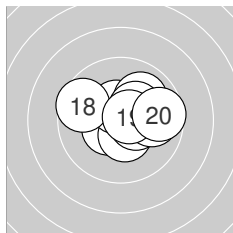

**Serie 2:**

10.5 *	10.4 *	10.5 *	10.4 *	9.9 →
10.0 ↗	10.3 *	9.6 ↖	10.6 *	9.7 →

beste Teiler: 77.2 (19.), 115.7 (13.), 121.2 (11.)  
 Trefferlage: 0.65 mm rechts, 0.37 mm hoch  
 Streuwert: 1.46, horizontal: 1.84, vertikal: 0.94

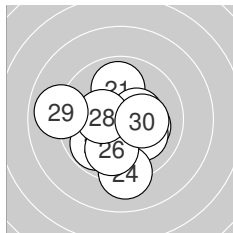

**Serie 3:**

9.9 ↑	10.1 ↘	10.1 ↘	9.2 ↓	9.8 ↗
9.9 ↓	10.4 *	10.3 *	9.0 ←	10.2 *

beste Teiler: 137.5 (27.), 154.5 (28.), 178.6 (30.)  
 Trefferlage: 0.22 mm links, 0.71 mm tief  
 Streuwert: 2.06, horizontal: 2.18, vertikal: 1.93

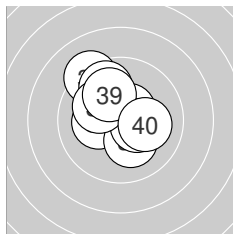

**Serie 4:**

10.5 *	10.2 *	10.2 *	9.2 ↘	10.5 *
10.4 *	9.8 ↘	10.1 ↘	10.0 ↗	10.1 →

beste Teiler: 105.8 (35.), 123.9 (31.), 144.2 (36.)  
 Trefferlage: 0.25 mm links, 0.67 mm hoch  
 Streuwert: 1.64, horizontal: 1.58, vertikal: 1.70



Ergebnis: **390.2** (372)  
 Serien: 99.0 98.4 96.5 96.3  
 Zähler: 15 23 1 1 0 0 0 0 0 0  
 Innenzehner: 13  
 Weitester: 846 (25.), 656 (38.), 465 (36.)  
 beste Teiler: 52.7 (39.), 97.3 (7.), 97.6 (18.)  
 Trefferlage: 0.37 mm rechts, 0.39 mm tief  
 Streuwert: 2.38, horizontal: 3.00, vertikal: 1.53

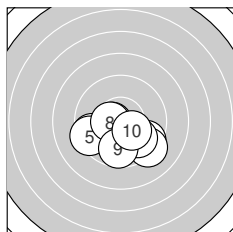
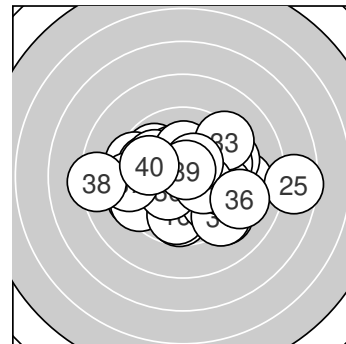

**Serie 1:**  
 9.5 ↘ 10.4 \* 9.2 ↘ 9.5 ← 9.4 ←  
 9.9 ↘ 10.6 \* 10.5 \* 9.7 ↓ 10.3 \*  
 beste Teiler: 97.3 (7.), 118.1 (8.), 135.5 (2.)  
 Trefferlage: 0.00 mm, 1.57 mm tief  
 Streuwert: 1.81, horizontal: 2.34, vertikal: 1.03

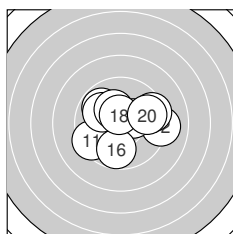

**Serie 2:**  
 9.4 ← 9.1 → 10.3 \* 9.8 ↖ 10.0 ↖  
 9.8 ↓ 10.3 \* 10.6 \* 9.4 → 9.7 →  
 beste Teiler: 97.6 (18.), 154.7 (13.), 175.3 (17.)  
 Trefferlage: 0.36 mm rechts, 0.30 mm hoch  
 Streuwert: 2.20, horizontal: 2.68, vertikal: 1.58

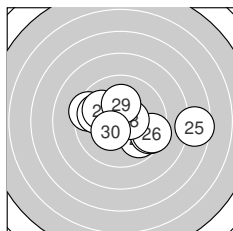

**Serie 3:**  
 9.8 ↘ 9.4 ← 9.8 ← 9.5 ↘ 7.6 →  
 9.4 → 10.0 ↖ 10.5 \* 10.2 \* 10.3 \*  
 beste Teiler: 102.2 (28.), 156.3 (30.), 195.0 (29.)  
 Trefferlage: 0.87 mm rechts, 0.11 mm tief  
 Streuwert: 2.74, horizontal: 3.64, vertikal: 1.35

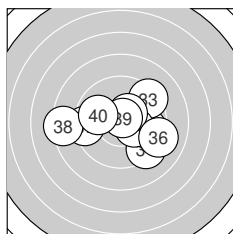

**Serie 4:**  
 9.3 ↘ 9.7 → 9.3 ↗ 10.3 \* 10.4 \*  
 9.1 → 9.3 ← 8.3 ← 10.7 \* 9.9 ←  
 beste Teiler: 52.7 (39.), 129.4 (35.), 166.2 (34.)  
 Trefferlage: 0.27 mm rechts, 0.20 mm tief  
 Streuwert: 2.76, horizontal: 3.56, vertikal: 1.58



Ergebnis: **378.6** (361)  
 Serien: 97.7 89.7 95.3 95.9  
 Zähler: 13 16 10 1 0 0 0 0 0 0  
 Innenzehner: 8  
 Weitester: 791 (13.), 687 (19.), 664 (31.)  
 beste Teiler: 45.0 (26.), 122.4 (34.), 135.2 (3.)  
 Trefferlage: 0.84 mm links, 0.08 mm hoch  
 Streuwert: 2.92, horizontal: 3.33, vertikal: 2.44

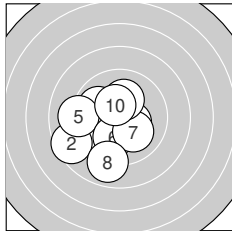
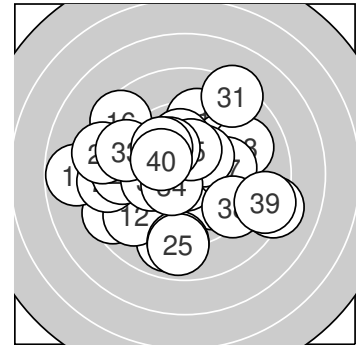

**Serie 1:**

9.9 ↙	8.6 ↙	10.4 *	9.9 ↘	9.2 ←
10.1 ↓	10.1 ↘	8.9 ↓	10.2 *	10.4 *

beste Teiler: 135.2 (3.), 141.0 (10.), 196.2 (9.)  
 Trefferlage: 1.35 mm links, 0.91 mm tief  
 Streuwert: 2.19, horizontal: 2.26, vertikal: 2.11

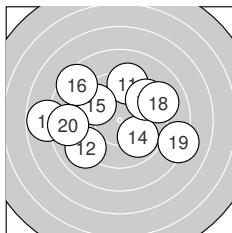

**Serie 2:**

9.3 ↑	9.0 ↙	7.8 ←	9.9 ↘	9.7 ↘
8.5 ↘	9.5 ↗	9.1 ↗	8.2 ↘	8.7 ←

beste Teiler: 269.0 (14.), 312.8 (15.), 365.4 (17.)  
 Trefferlage: 0.81 mm links, 0.60 mm hoch  
 Streuwert: 3.80, horizontal: 4.75, vertikal: 2.52

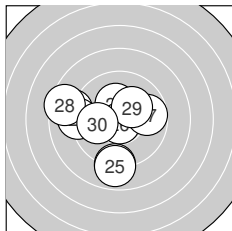

**Serie 3:**

8.8 ←	10.3 *	9.1 ←	9.0 ↓	8.9 ↓
10.8 *	9.7 →	8.5 ←	10.2 *	10.0 ←

beste Teiler: 45.0 (26.), 173.6 (22.), 188.8 (29.)  
 Trefferlage: 1.53 mm links, 0.48 mm tief  
 Streuwert: 2.74, horizontal: 2.94, vertikal: 2.52

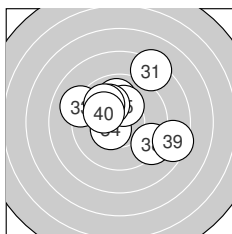

**Serie 4:**

8.3 ↗	9.9 ↑	9.1 ↘	10.5 *	10.2 *
10.1 ↘	9.9 ↘	9.3 ↘	8.5 ↘	10.1 ↘

beste Teiler: 122.4 (34.), 183.3 (35.), 202.8 (40.)  
 Trefferlage: 0.30 mm rechts, 1.13 mm hoch  
 Streuwert: 2.74, horizontal: 3.05, vertikal: 2.38



Ergebnis: **389.5** (375)  
 Serien: 94.9 97.4 96.8 100.4  
 Zähler: 19 17 4 0 0 0 0 0 0  
 Innenzehner: 10  
 Weitester: 747 (18.), 679 (2.), 573 (30.)  
 beste Teiler: 84.2 (26.), 109.2 (35.), 111.3 (17.)  
 Trefferlage: 0.83 mm rechts, 0.81 mm hoch  
 Streuwert: 2.29, horizontal: 2.85, vertikal: 1.55

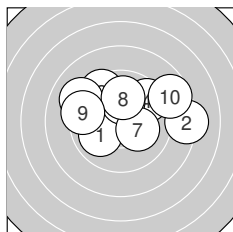
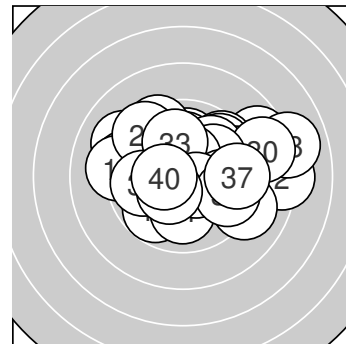

**Serie 1:**  
 10.0 ↙                      8.2 →                      9.5 ↘                      9.6 ↗                      10.2 \*  
    9.1 ↘                      10.2 \*                      10.0 ↑                      9.4 ↖                      8.7 ↖  
 beste Teiler: 192.5 (5.), 194.1 (7.), 243.2 (8.)  
 Trefferlage: 0.48 mm rechts, 1.29 mm hoch  
 Streuwert: 2.80, horizontal: 3.65, vertikal: 1.55

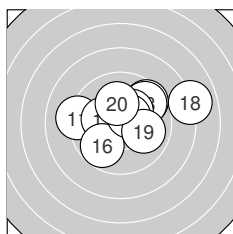

**Serie 2:**  
 9.2 ←                      9.6 ↗                      9.7 ↗                      10.3 \*                      10.2 \*  
    9.8 ↗                      10.5 \*                      8.0 →                      10.0 →                      10.1 ↑  
 beste Teiler: 111.3 (17.), 167.1 (14.), 185.8 (15.)  
 Trefferlage: 0.81 mm rechts, 0.82 mm hoch  
 Streuwert: 2.49, horizontal: 3.20, vertikal: 1.47

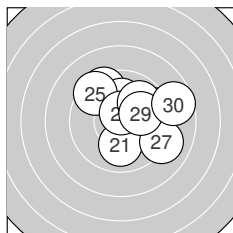

**Serie 3:**  
 10.0 ↓                      9.4 →                      9.5 ↘                      10.1 ↑                      9.4 ↘  
    10.6 \*                      9.1 ↘                      9.9 ↗                      10.1 →                      8.7 →  
 beste Teiler: 84.2 (26.), 217.1 (24.), 221.5 (29.)  
 Trefferlage: 1.30 mm rechts, 1.03 mm hoch  
 Streuwert: 2.28, horizontal: 2.60, vertikal: 1.91

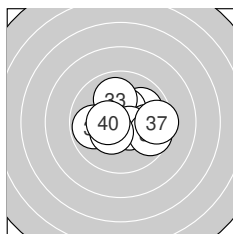

**Serie 4:**  
 10.0 ↗                      10.4 \*                      10.0 ↑                      9.8 →                      10.5 \*  
    9.6 →                      9.5 →                      9.8 ←                      10.4 \*                      10.4 \*  
 beste Teiler: 109.2 (35.), 129.1 (40.), 136.1 (32.)  
 Trefferlage: 0.73 mm rechts, 0.11 mm hoch  
 Streuwert: 1.71, horizontal: 2.13, vertikal: 1.16



Ergebnis: **396.2** (379)  
 Serien: 96.8 102.9 99.0 97.5  
 Zähler: 22 15 3 0 0 0 0 0 0  
 Innenzehner: 16  
 Weitestе: 615 (5.), 599 (28.), 553 (33.)  
 beste Teiler: 44.1 (38.), 62.8 (12.), 73.0 (27.)  
 Trefferlage: 0.34 mm rechts, 0.57 mm hoch  
 Streuwert: 2.10, horizontal: 2.54, vertikal: 1.54

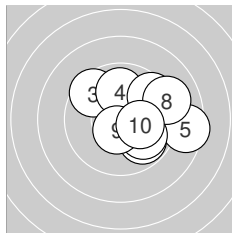
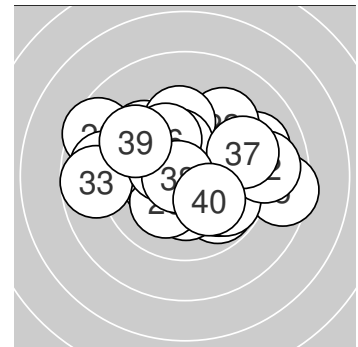

**Serie 1:**  
 9.8 ↘                      9.9 ↗                      9.5 ↘                      9.9 ↑                      8.5 →  
 9.5 ↗                      9.9 ↘                      9.1 ↗                      10.5 \*                      10.2 \*  
 beste Teiler: 105.9 (9.), 188.7 (10.), 256.0 (4.)  
 Trefferlage: 1.85 mm rechts, 0.46 mm hoch  
 Streuwert: 2.13, horizontal: 2.43, vertikal: 1.77

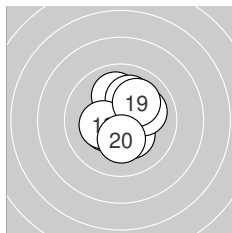

**Serie 2:**  
 10.4 \*                      10.7 \*                      10.3 \*                      10.6 \*                      10.0 ↑  
 10.1 ↗                      10.1 →                      10.3 \*                      10.1 ↗                      10.3 \*  
 beste Teiler: 62.8 (12.), 89.9 (14.), 146.6 (11.)  
 Trefferlage: 0.29 mm rechts, 0.36 mm hoch  
 Streuwert: 1.28, horizontal: 1.17, vertikal: 1.38

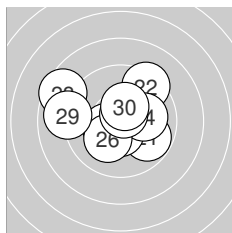

**Serie 3:**  
 9.8 ↘                      9.3 ↗                      10.5 \*                      10.1 →                      10.4 \*  
 10.2 \*                      10.7 \*                      8.6 ↘                      9.0 ←                      10.4 \*  
 beste Teiler: 73.0 (27.), 106.0 (23.), 142.4 (30.)  
 Trefferlage: 0.52 mm links, 0.41 mm hoch  
 Streuwert: 2.30, horizontal: 2.80, vertikal: 1.66

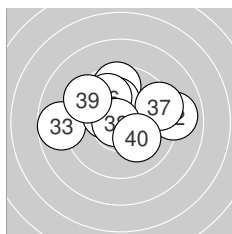

**Serie 4:**  
 9.6 ↑                      9.0 →                      8.7 ←                      10.4 \*                      10.2 \*  
 9.9 ↘                      9.4 →                      10.8 \*                      9.4 ↘                      10.1 ↘  
 beste Teiler: 44.1 (38.), 150.7 (34.), 200.3 (35.)  
 Trefferlage: 0.23 mm links, 1.06 mm hoch  
 Streuwert: 2.38, horizontal: 3.04, vertikal: 1.45





Ergebnis: **394.1** (375)  
 Serien: 98.4 99.4 101.0 95.3  
 Zähler: 19 17 4 0 0 0 0 0 0 0  
 Innenzehner: 15  
 Weitester: 730 (39.), 540 (18.), 528 (33.)  
 beste Teiler: 56.8 (14.), 110.8 (21.), 111.3 (10.)  
 Trefferlage: 0.07 mm links, 0.30 mm tief  
 Streuwert: 2.19, horizontal: 2.55, vertikal: 1.77

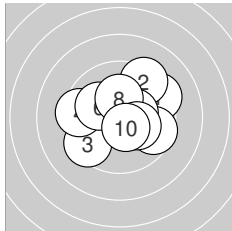
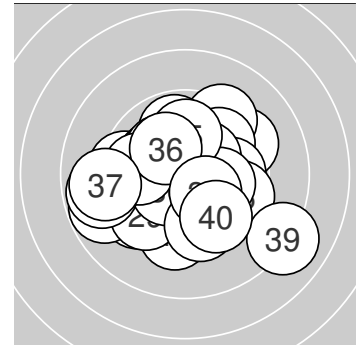

**Serie 1:**

9.3 ↗	9.3 ↗	9.4 ↙	9.4 ←	9.6 →
10.1 ↖	10.4 *	10.2 *	10.2 *	10.5 *

beste Teiler: 111.3 (10.), 142.6 (7.), 177.0 (8.)  
 Trefferlage: 0.38 mm rechts, 0.35 mm hoch  
 Streuwert: 2.17, horizontal: 2.54, vertikal: 1.73

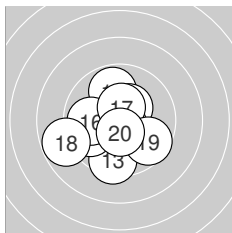

**Serie 2:**

9.8 ↑	10.4 *	9.4 ↓	10.7 *	9.8 ↙
9.9 ←	10.5 *	8.8 ↙	9.6 ↘	10.5 *

beste Teiler: 56.8 (14.), 112.2 (20.), 122.0 (17.)  
 Trefferlage: 0.76 mm links, 0.54 mm tief  
 Streuwert: 2.03, horizontal: 2.17, vertikal: 1.88

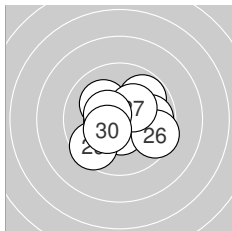

**Serie 3:**

10.5 *	10.5 *	10.1 ↖	9.8 ↗	9.8 →
9.5 ↘	10.3 *	10.5 *	9.6 ↙	10.4 *

beste Teiler: 110.8 (21.), 114.0 (22.), 121.6 (28.)  
 Trefferlage: 0.23 mm rechts, 0.12 mm tief  
 Streuwert: 1.73, horizontal: 2.01, vertikal: 1.38

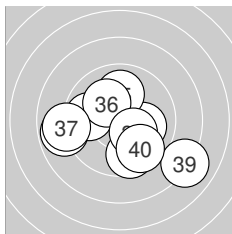

**Serie 4:**

10.1 →	9.6 ↓	8.8 ←	9.8 ←	10.0 ↑
10.2 *	8.9 ←	10.3 *	8.0 ↘	9.6 ↘

beste Teiler: 170.0 (38.), 200.0 (36.), 221.7 (31.)  
 Trefferlage: 0.17 mm links, 0.89 mm tief  
 Streuwert: 2.85, horizontal: 3.48, vertikal: 2.03



Ergebnis: **401.6** (382)  
 Serien: 99.3 101.9 100.9 99.5  
 Zähler: 24 14 2 0 0 0 0 0 0 0  
 Innenzehner: 23  
 Weitestе: 644 (32.), 504 (3.), 482 (39.)  
 beste Teiler: 5.8 (16.), 40.8 (22.), 69.2 (7.)  
 Trefferlage: 0.21 mm links, 0.41 mm hoch  
 Streuwert: 1.89, horizontal: 2.29, vertikal: 1.38

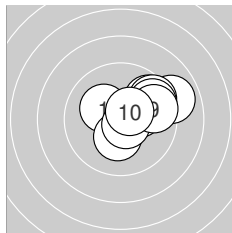
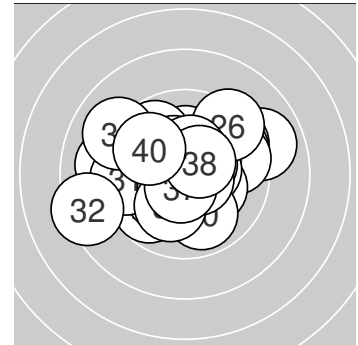

**Serie 1:**  
 10.2 \*                      10.2 \*                      8.9 ↗                      9.7 ↗                      10.3 \*  
 9.5 ↗                      10.7 \*                      9.6 ↗                      9.7 ↗                      10.5 \*  
 beste Teiler: 69.2 (7.), 111.2 (10.), 164.2 (5.)  
 Trefferlage: 1.75 mm rechts, 0.83 mm hoch  
 Streuwert: 1.55, horizontal: 1.87, vertikal: 1.13

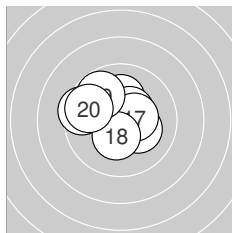

**Serie 2:**  
 9.5 ←                      10.3 \*                      10.2 \*                      10.2 \*                      10.5 \*  
 10.9 \*                      10.4 \*                      10.4 \*                      9.8 ↘                      9.7 ←  
 beste Teiler: 5.8 (16.), 122.3 (15.), 130.0 (17.)  
 Trefferlage: 0.64 mm links, 0.61 mm hoch  
 Streuwert: 1.49, horizontal: 1.76, vertikal: 1.16

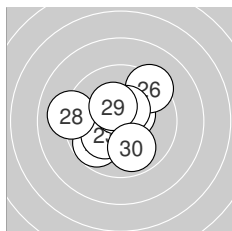

**Serie 3:**  
 9.8 ↙                      10.8 \*                      10.2 \*                      10.5 \*                      10.5 \*  
 9.3 ↗                      10.5 \*                      9.1 ←                      10.3 \*                      9.9 ↘  
 beste Teiler: 40.8 (22.), 108.2 (25.), 117.6 (24.)  
 Trefferlage: 0.39 mm links, 0.24 mm hoch  
 Streuwert: 1.85, horizontal: 2.01, vertikal: 1.68

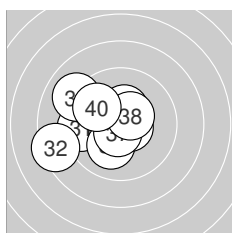

**Serie 4:**  
 9.5 ←                      8.4 ←                      10.5 \*                      10.4 \*                      10.1 ↙  
 10.6 \*                      10.6 \*                      10.5 \*                      9.0 ↘                      9.9 ↘  
 beste Teiler: 82.2 (37.), 84.8 (36.), 107.8 (33.)  
 Trefferlage: 1.58 mm links, 0.00 mm  
 Streuwert: 1.99, horizontal: 2.35, vertikal: 1.54



Ergebnis: **402.7** (385)  
 Serien: 101.6 100.4 98.9 101.8  
 Zähler: 25 15 0 0 0 0 0 0 0 0  
 Innenzehner: 19  
 Weitestе: 432 (32.), 397 (24.), 389 (21.)  
 beste Teiler: 12.1 (5.), 18.6 (39.), 67.1 (36.)  
 Trefferlage: 0.13 mm links, 0.09 mm hoch  
 Streuwert: 1.76, horizontal: 1.95, vertikal: 1.54

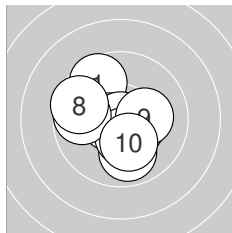
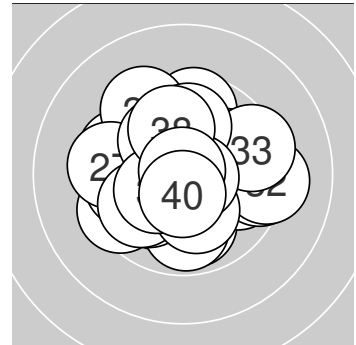

**Serie 1:**  
 9.6 ↘                      10.6 \*                      10.4 \*                      9.9 ↓                      10.9 \*  
 10.4 \*                      9.8 ←                      9.6 ↖                      10.2 \*                      10.2 \*  
 beste Teiler: 12.1 (5.), 87.3 (2.), 130.5 (3.)  
 Trefferlage: 0.43 mm links, 0.21 mm tief  
 Streuwert: 1.63, horizontal: 1.72, vertikal: 1.53

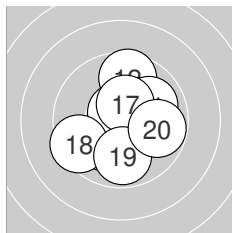

**Serie 2:**  
 10.1 ↗                      9.6 ↑                      10.2 \*                      10.0 →                      10.3 \*  
 10.7 \*                      10.4 \*                      9.5 ↙                      9.8 ↓                      9.8 →  
 beste Teiler: 68.8 (16.), 130.0 (17.), 160.5 (15.)  
 Trefferlage: 0.43 mm rechts, 0.00 mm  
 Streuwert: 1.79, horizontal: 1.77, vertikal: 1.81

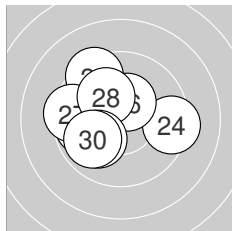

**Serie 3:**  
 9.4 ↘                      10.3 \*                      10.2 \*                      9.4 →                      9.8 ←  
 10.4 \*                      9.4 ←                      10.1 ↘                      10.0 ↗                      9.9 ↙  
 beste Teiler: 141.5 (26.), 166.6 (22.), 193.2 (23.)  
 Trefferlage: 1.22 mm links, 0.46 mm hoch  
 Streuwert: 1.85, horizontal: 2.13, vertikal: 1.53

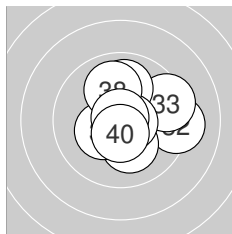

**Serie 4:**  
 10.6 \*                      9.2 →                      9.4 →                      10.0 ↑                      10.2 \*  
 10.7 \*                      10.3 \*                      10.0 ↑                      10.9 \*                      10.5 \*  
 beste Teiler: 18.6 (39.), 67.1 (36.), 94.4 (31.)  
 Trefferlage: 0.69 mm rechts, 0.13 mm hoch  
 Streuwert: 1.65, horizontal: 1.82, vertikal: 1.46



Ergebnis: **0.0** (0)  
Serien: 0.0  
Zähler: 0 0 0 0 0 0 0 0 0 0  
Innenzehner: 0  
Weiteste: 230 (1.)  
beste Teiler: 230.1 (1.)  
Trefferlage: 1.19 mm rechts, 1.97 mm hoch  
Streuwert:

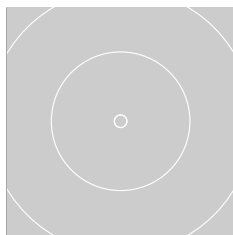
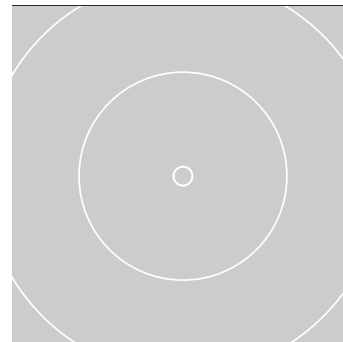

**Serie 1:**

0.0

beste Teiler: 230.1 (1.)  
Trefferlage: 1.19 mm rechts, 1.97 mm hoch  
Streuwert: 0.00, horizontal: 0.00, vertikal: 0.00

Ergebnis: **387.4** (370)  
 Serien: 95.8 95.1 98.4 98.1  
 Zähler: 17 16 7 0 0 0 0 0 0 0  
 Innenzehner: 14  
 Weitester: 623 (17.), 620 (36.), 584 (7.)  
 beste Teiler: 36.8 (20.), 40.3 (38.), 73.5 (14.)  
 Trefferlage: 0.05 mm rechts, 0.18 mm tief  
 Streuwert: 2.59, horizontal: 3.08, vertikal: 1.98

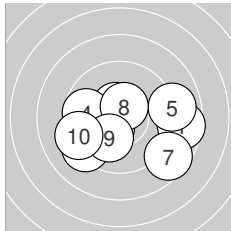
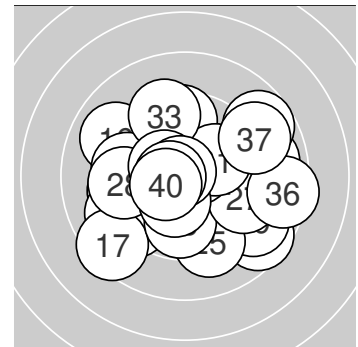

**Serie 1:**

8.6 →	10.4 *	10.5 *	9.7 ←	8.9 →
9.2 ↙	8.6 ↘	10.5 *	10.1 ↘	9.3 ←

beste Teiler: 108.1 (3.), 109.7 (8.), 134.1 (2.)  
 Trefferlage: 0.33 mm rechts, 0.85 mm tief  
 Streuwert: 2.78, horizontal: 3.56, vertikal: 1.69

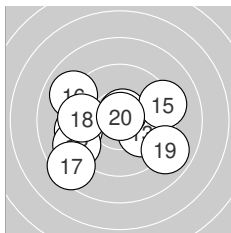

**Serie 2:**

9.4 ←	9.1 ↙	10.0 ↘	10.7 *	9.2 →
9.0 ↘	8.5 ↙	9.5 ←	8.9 ↘	10.8 *

beste Teiler: 36.8 (20.), 73.5 (14.), 237.9 (13.)  
 Trefferlage: 0.95 mm links, 0.63 mm tief  
 Streuwert: 2.89, horizontal: 3.54, vertikal: 2.05

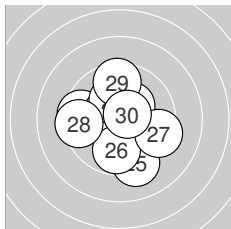

**Serie 3:**

9.5 ←	10.3 *	10.4 *	10.2 *	9.2 ↘
9.8 ↓	9.4 ↘	9.4 ←	9.6 ↑	10.6 *

beste Teiler: 85.4 (30.), 131.8 (23.), 163.8 (22.)  
 Trefferlage: 0.28 mm links, 0.07 mm tief  
 Streuwert: 2.24, horizontal: 2.26, vertikal: 2.21

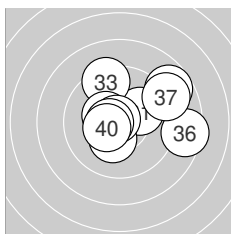

**Serie 4:**

10.1 ↗	8.7 ↗	9.3 ↑	10.3 *	10.4 *
8.5 →	9.0 ↗	10.8 *	10.6 *	10.4 *

beste Teiler: 40.3 (38.), 94.1 (39.), 130.7 (40.)  
 Trefferlage: 1.13 mm rechts, 0.80 mm hoch  
 Streuwert: 2.39, horizontal: 2.88, vertikal: 1.78



Ergebnis: **399.6** (380)  
 Serien: 100.9 101.1 98.2 99.4  
 Zähler: 20 20 0 0 0 0 0 0 0 0  
 Innenzehner: 15  
 Weitestе: 486 (35.), 454 (12.), 438 (26.)  
 beste Teiler: 23.1 (23.), 54.0 (7.), 60.2 (32.)  
 Trefferlage: 0.23 mm links, 0.33 mm hoch  
 Streuwert: 1.89, horizontal: 2.21, vertikal: 1.52

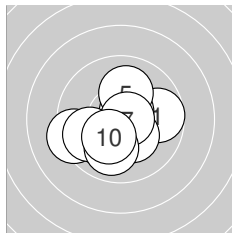
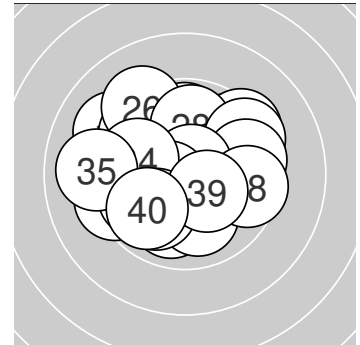

**Serie 1:**  
 9.7 → 9.3 ← 10.6 \* 10.3 \* 10.1 ↑  
 10.1 ↙ 10.7 \* 9.8 ↘ 10.0 ↓ 10.3 \*  
 beste Teiler: 54.0 (7.), 81.4 (3.), 164.2 (4.)  
 Trefferlage: 0.40 mm links, 0.63 mm tief  
 Streuwert: 1.69, horizontal: 1.94, vertikal: 1.38

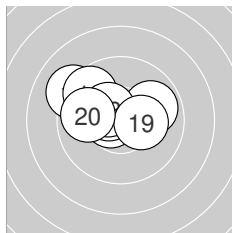

**Serie 2:**  
 9.9 → 9.1 ↘ 10.2 \* 10.6 \* 9.6 ↘  
 10.6 \* 10.5 \* 10.4 \* 10.3 \* 9.9 ←  
 beste Teiler: 82.0 (16.), 86.9 (14.), 110.1 (17.)  
 Trefferlage: 1.02 mm links, 0.84 mm hoch  
 Streuwert: 1.49, horizontal: 1.93, vertikal: 0.85

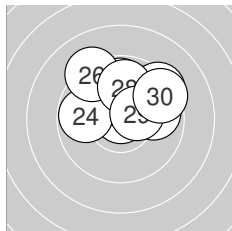

**Serie 3:**  
 9.8 → 9.8 ↑ 10.9 \* 9.8 ← 9.6 ↗  
 9.2 ↘ 9.4 ↗ 9.9 ↑ 10.4 \* 9.4 ↗  
 beste Teiler: 23.1 (23.), 144.2 (29.), 268.1 (28.)  
 Trefferlage: 0.80 mm rechts, 1.73 mm hoch  
 Streuwert: 1.78, horizontal: 2.18, vertikal: 1.24

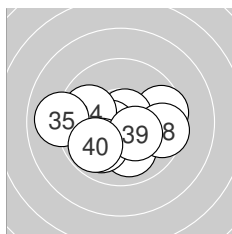

**Serie 4:**  
 9.6 → 10.7 \* 10.5 \* 9.9 ← 9.0 ←  
 10.0 ↓ 10.0 ↙ 9.6 → 10.3 \* 9.8 ↙  
 beste Teiler: 60.2 (32.), 101.1 (33.), 153.2 (39.)  
 Trefferlage: 0.29 mm links, 0.58 mm tief  
 Streuwert: 2.03, horizontal: 2.63, vertikal: 1.16



Ergebnis: **412.0** (393)  
 Serien: 102.4 102.1 105.1 102.4  
 Zähler: 33 7 0 0 0 0 0 0 0 0  
 Innenzehner: 30  
 Weitestе: 401 (39.), 398 (2.), 317 (16.)  
 beste Teiler: 35.3 (10.), 42.1 (34.), 45.8 (36.)  
 Trefferlage: 0.27 mm rechts, 0.24 mm tief  
 Streuwert: 1.31, horizontal: 1.57, vertikal: 0.98

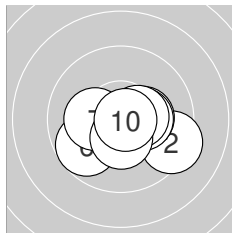
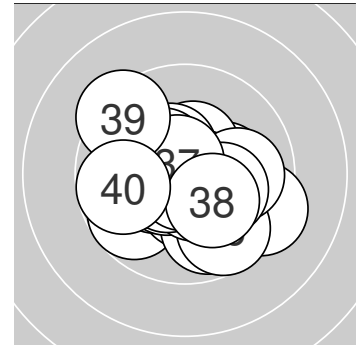

**Serie 1:**

10.3 *	9.4 ↘	10.3 *	10.5 *	10.3 *
9.7 ↙	10.2 *	10.5 *	10.4 *	10.8 *

beste Teiler: 35.3 (10.), 108.7 (4.), 123.3 (8.)  
 Trefferlage: 0.56 mm rechts, 0.59 mm tief  
 Streuwert: 1.37, horizontal: 1.77, vertikal: 0.79

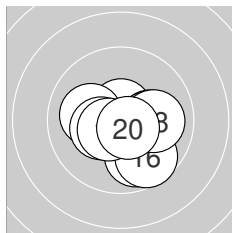

**Serie 2:**

10.7 *	10.1 →	10.1 ←	10.2 *	9.9 ↘
9.7 ↘	10.3 *	10.0 →	10.5 *	10.6 *

beste Teiler: 72.0 (11.), 76.3 (20.), 109.0 (19.)  
 Trefferlage: 0.55 mm rechts, 0.61 mm tief  
 Streuwert: 1.38, horizontal: 1.60, vertikal: 1.11

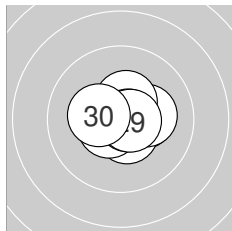

**Serie 3:**

10.8 *	10.3 *	10.5 *	10.6 *	10.6 *
10.2 *	10.4 *	10.7 *	10.7 *	10.3 *

beste Teiler: 50.5 (21.), 53.7 (28.), 68.8 (29.)  
 Trefferlage: 0.28 mm rechts, 0.00 mm  
 Streuwert: 0.85, horizontal: 1.05, vertikal: 0.58

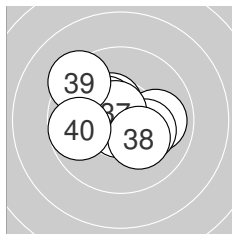

**Serie 4:**

10.4 *	9.9 →	10.4 *	10.8 *	10.2 *
10.8 *	10.7 *	10.2 *	9.3 ↘	9.7 ←

beste Teiler: 42.1 (34.), 45.8 (36.), 68.7 (37.)  
 Trefferlage: 0.30 mm links, 0.23 mm hoch  
 Streuwert: 1.52, horizontal: 1.81, vertikal: 1.16



Ergebnis: **399.3** (380)  
 Serien: 100.0 98.1 100.9 100.3  
 Zähler: 21 18 1 0 0 0 0 0 0 0  
 Innenzehner: 14  
 Weitester: 618 (16.), 484 (31.), 407 (3.)  
 beste Teiler: 52.4 (19.), 63.0 (8.), 67.1 (5.)  
 Trefferlage: 0.08 mm rechts, 0.33 mm hoch  
 Streuwert: 1.93, horizontal: 2.38, vertikal: 1.33

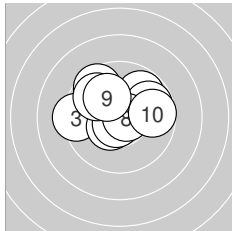
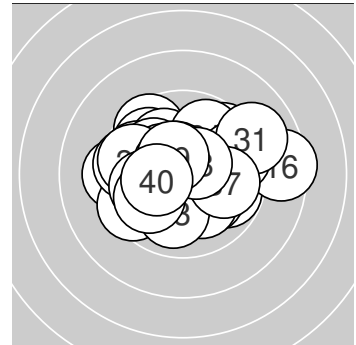

**Serie 1:**

9.8 ↗	9.6 ↘	9.3 ←	10.5 *	10.7 *
9.8 ↘	9.8 ↗	10.7 *	10.1 ↘	9.7 →

beste Teiler: 63.0 (8.), 67.1 (5.), 122.3 (4.)  
 Trefferlage: 0.23 mm links, 0.87 mm hoch  
 Streuwert: 1.86, horizontal: 2.32, vertikal: 1.26

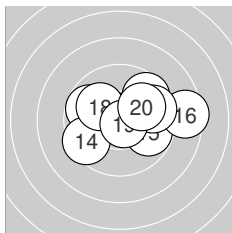

**Serie 2:**

9.7 ↖	9.6 ↗	10.6 *	9.5 ↖	9.8 →
8.5 →	9.6 →	10.1 ↘	10.7 *	10.0 →

beste Teiler: 52.4 (19.), 94.5 (13.), 223.5 (18.)  
 Trefferlage: 0.83 mm rechts, 0.45 mm hoch  
 Streuwert: 2.29, horizontal: 2.99, vertikal: 1.25

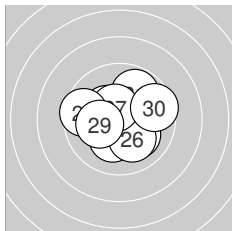

**Serie 3:**

9.8 ↗	10.2 *	10.5 *	10.3 *	10.1 ↘
10.1 ↘	10.5 *	9.6 ←	10.2 *	9.6 →

beste Teiler: 113.4 (27.), 125.6 (23.), 153.6 (24.)  
 Trefferlage: 0.09 mm rechts, 0.00 mm  
 Streuwert: 1.72, horizontal: 1.97, vertikal: 1.44

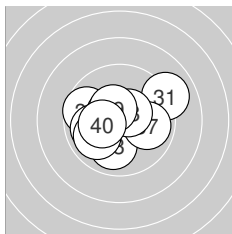

**Serie 4:**

9.0 ↗	9.7 ↖	10.0 ↓	10.0 ↖	9.9 ↖
10.5 *	9.9 →	10.5 *	10.5 *	10.3 *

beste Teiler: 107.2 (38.), 107.6 (36.), 123.6 (39.)  
 Trefferlage: 0.36 mm links, 0.00 mm  
 Streuwert: 1.90, horizontal: 2.32, vertikal: 1.36





Ergebnis: **412.0** (395)  
 Serien: 102.6 104.0 104.2 101.2  
 Zähler: 35 5 0 0 0 0 0 0 0  
 Innenzehner: 27  
 Weitestе: 364 (38.), 360 (35.), 300 (37.)  
 beste Teiler: 35.3 (33.), 37.4 (28.), 39.5 (34.)  
 Trefferlage: 0.20 mm links, 0.16 mm hoch  
 Streuwert: 1.30, horizontal: 1.51, vertikal: 1.05

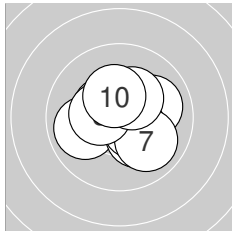
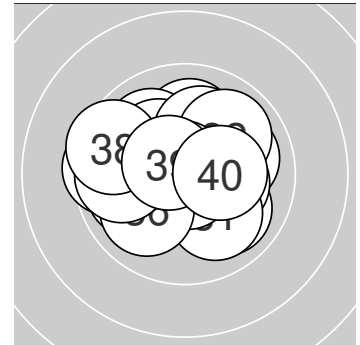

**Serie 1:**

9.9 ←	10.0 →	10.6 *	10.4 *	10.2 *
10.5 *	10.0 ↘	10.4 *	10.3 *	10.3 *

beste Teiler: 78.3 (3.), 125.6 (6.), 126.7 (4.)  
 Trefferlage: 0.26 mm rechts, 0.04 mm hoch  
 Streuwert: 1.33, horizontal: 1.53, vertikal: 1.10

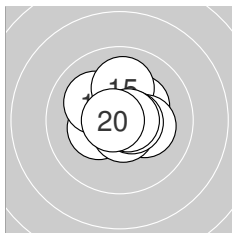

**Serie 2:**

10.3 *	10.4 *	10.3 *	10.1 ↖	10.0 ↑
10.2 *	10.6 *	10.6 *	10.7 *	10.8 *

beste Teiler: 48.0 (20.), 59.0 (19.), 79.3 (17.)  
 Trefferlage: 0.01 mm rechts, 0.35 mm hoch  
 Streuwert: 1.09, horizontal: 1.20, vertikal: 0.97

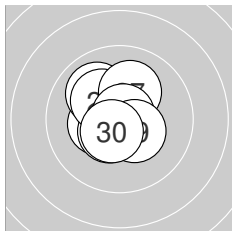

**Serie 3:**

10.6 *	10.4 *	10.7 *	10.5 *	10.0 ↗
10.2 *	10.1 ↑	10.8 *	10.4 *	10.5 *

beste Teiler: 37.4 (28.), 72.3 (23.), 87.0 (21.)  
 Trefferlage: 0.34 mm links, 0.24 mm hoch  
 Streuwert: 1.05, horizontal: 0.98, vertikal: 1.11

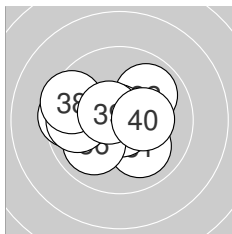

**Serie 4:**

10.0 ↘	9.9 ↗	10.8 *	10.8 *	9.5 ←
10.0 ↙	9.8 ←	9.5 ↖	10.6 *	10.3 *

beste Teiler: 35.3 (33.), 39.5 (34.), 93.2 (39.)  
 Trefferlage: 0.76 mm links, 0.03 mm hoch  
 Streuwert: 1.69, horizontal: 2.11, vertikal: 1.13



Ergebnis: **407.2** (391)  
 Serien: 100.8 101.9 101.9 102.6  
 Zähler: 31 9 0 0 0 0 0 0 0  
 Innenzehner: 25  
 Weitester: 458 (40.), 432 (21.), 418 (10.)  
 beste Teiler: 13.0 (16.), 43.2 (35.), 68.8 (5.)  
 Trefferlage: 0.01 mm rechts, 0.11 mm tief  
 Streuwert: 1.59, horizontal: 1.82, vertikal: 1.33

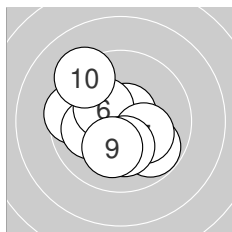
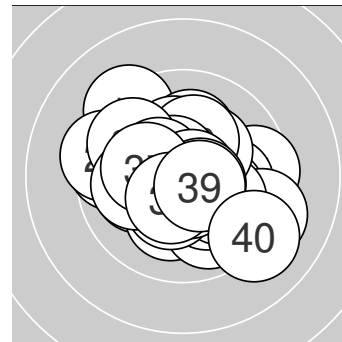

**Serie 1:**  
 9.6 ←                      10.5 \*                      10.1 ←                      9.8 ↘                      10.7 \*  
 10.3 \*                      10.2 \*                      10.2 \*                      10.1 ↓                      9.3 ↗  
 beste Teiler: 68.8 (5.), 106.1 (2.), 159.6 (6.)  
 Trefferlage: 0.60 mm links, 0.27 mm tief  
 Streuwert: 1.73, horizontal: 1.83, vertikal: 1.63

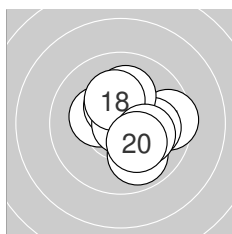

**Serie 2:**  
 9.5 →                      10.3 \*                      10.4 \*                      10.1 →                      10.1 ↑  
 10.9 \*                      9.9 ↘                      10.3 \*                      10.2 \*                      10.2 \*  
 beste Teiler: 13.0 (16.), 133.3 (13.), 164.4 (12.)  
 Trefferlage: 0.79 mm rechts, 0.07 mm hoch  
 Streuwert: 1.44, horizontal: 1.50, vertikal: 1.37

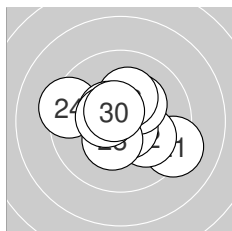

**Serie 3:**  
 9.2 ↘                      10.1 ↘                      10.7 \*                      9.4 ←                      10.3 \*  
 10.2 \*                      10.5 \*                      10.4 \*                      10.5 \*                      10.6 \*  
 beste Teiler: 74.9 (23.), 88.2 (30.), 114.2 (29.)  
 Trefferlage: 0.10 mm rechts, 0.08 mm hoch  
 Streuwert: 1.69, horizontal: 2.05, vertikal: 1.23

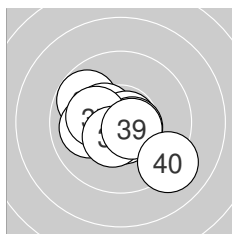

**Serie 4:**  
 10.6 \*                      9.8 ↘                      10.4 \*                      10.0 ←                      10.8 \*  
 10.6 \*                      10.2 \*                      10.5 \*                      10.6 \*                      9.1 ↘  
 beste Teiler: 43.2 (35.), 87.6 (31.), 94.0 (36.)  
 Trefferlage: 0.25 mm links, 0.34 mm tief  
 Streuwert: 1.54, horizontal: 1.82, vertikal: 1.21



Ergebnis: **407.9** (391)  
 Serien: 99.4 102.7 102.9 102.9  
 Zähler: 32 7 1 0 0 0 0 0 0  
 Innenzehner: 25  
 Weitester: 549 (4.), 367 (10.), 349 (27.)  
 beste Teiler: 38.0 (21.), 52.6 (24.), 54.0 (23.)  
 Trefferlage: 0.13 mm rechts, 0.28 mm hoch  
 Streuwert: 1.51, horizontal: 1.66, vertikal: 1.35

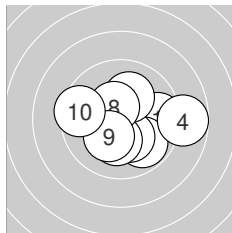
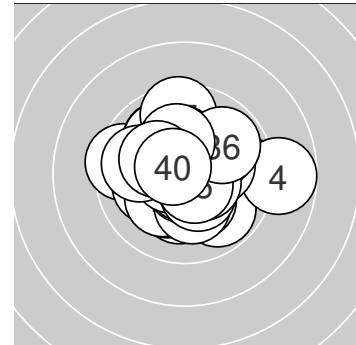

**Serie 1:**  
 9.6 →                      10.4 \*                      9.8 ↘                      8.8 →                      10.3 \*  
 10.2 \*                      10.1 ↑                      10.5 \*                      10.2 \*                      9.5 ←  
 beste Teiler: 122.5 (8.), 135.0 (2.), 173.0 (5.)  
 Trefferlage: 0.70 mm rechts, 0.44 mm tief  
 Streuwert: 2.01, horizontal: 2.48, vertikal: 1.38

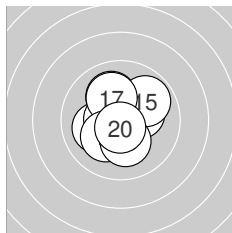

**Serie 2:**  
 10.1 ↘                      10.3 \*                      10.1 ←                      10.6 \*                      9.9 ↗  
 10.5 \*                      10.1 ↘                      10.2 \*                      10.2 \*                      10.7 \*  
 beste Teiler: 65.1 (20.), 83.3 (14.), 101.5 (16.)  
 Trefferlage: 0.18 mm links, 0.09 mm hoch  
 Streuwert: 1.36, horizontal: 1.31, vertikal: 1.42

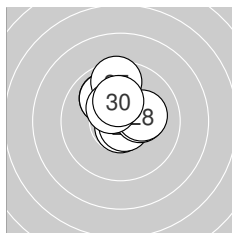

**Serie 3:**  
 10.8 \*                      10.0 ↘                      10.7 \*                      10.7 \*                      10.0 ↘  
 10.3 \*                      9.6 ↑                      10.2 \*                      10.4 \*                      10.2 \*  
 beste Teiler: 38.0 (21.), 52.6 (24.), 54.0 (23.)  
 Trefferlage: 0.00 mm , 1.03 mm hoch  
 Streuwert: 1.21, horizontal: 1.12, vertikal: 1.28

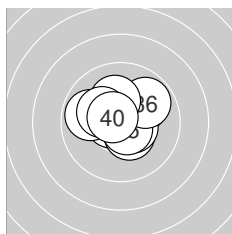

**Serie 4:**  
 10.6 \*                      10.1 ↗                      10.4 \*                      10.5 \*                      10.6 \*  
 9.8 ↗                      9.9 ←                      10.2 \*                      10.2 \*                      10.6 \*  
 beste Teiler: 83.0 (31.), 83.0 (40.), 84.9 (35.)  
 Trefferlage: 0.00 mm , 0.46 mm hoch  
 Streuwert: 1.30, horizontal: 1.53, vertikal: 1.01



Ergebnis: **414.2** (394)  
 Serien: 102.2 102.6 105.1 104.3  
 Zähler: 34 6 0 0 0 0 0 0 0 0  
 Innenzehner: 30  
 Weitesten: 377 (7.), 353 (11.), 295 (8.)  
 beste Teiler: 10.0 (2.), 13.0 (22.), 59.4 (21.)  
 Trefferlage: 0.12 mm rechts, 0.34 mm tief  
 Streuwert: 1.20, horizontal: 1.27, vertikal: 1.13

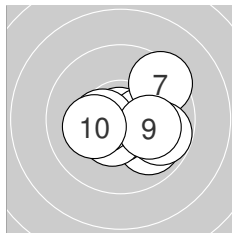
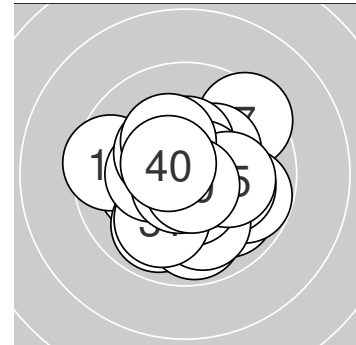

**Serie 1:**

9.9 ↘	10.9 *	10.6 *	10.5 *	10.4 *
10.4 *	9.4 ↗	9.8 ↘	10.1 →	10.2 *

beste Teiler: 10.0 (2.), 80.2 (3.), 120.8 (4.)  
 Trefferlage: 0.71 mm rechts, 0.32 mm tief  
 Streuwert: 1.45, horizontal: 1.71, vertikal: 1.13

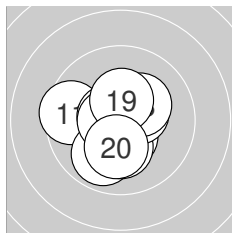

**Serie 2:**

9.5 ←	9.9 ↙	10.6 *	10.6 *	10.5 *
10.2 *	10.4 *	10.3 *	10.4 *	10.2 *

beste Teiler: 81.0 (14.), 87.2 (13.), 120.1 (15.)  
 Trefferlage: 0.36 mm links, 0.34 mm tief  
 Streuwert: 1.37, horizontal: 1.38, vertikal: 1.35

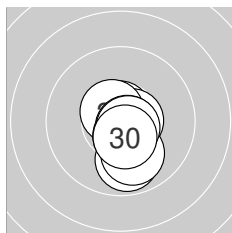

**Serie 3:**

10.7 *	10.9 *	10.6 *	9.9 ↓	10.6 *
10.7 *	10.0 ↓	10.5 *	10.7 *	10.5 *

beste Teiler: 13.0 (22.), 59.4 (21.), 62.9 (26.)  
 Trefferlage: 0.31 mm rechts, 0.66 mm tief  
 Streuwert: 0.85, horizontal: 0.42, vertikal: 1.13

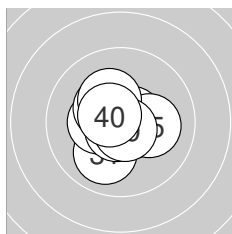

**Serie 4:**

10.0 ↙	10.6 *	10.6 *	10.3 *	10.1 →
10.4 *	10.3 *	10.7 *	10.7 *	10.6 *

beste Teiler: 59.9 (38.), 61.0 (39.), 80.0 (33.)  
 Trefferlage: 0.16 mm links, 0.04 mm tief  
 Streuwert: 1.05, horizontal: 1.11, vertikal: 0.99



Ergebnis: **403.9** (387)  
 Serien: 103.9 99.9 100.7 99.4  
 Zähler: 27 13 0 0 0 0 0 0 0 0  
 Innenzehner: 23  
 Weitestе: 492 (15.), 486 (14.), 437 (13.)  
 beste Teiler: 43.8 (2.), 64.8 (18.), 66.0 (26.)  
 Trefferlage: 0.06 mm rechts, 1.23 mm hoch  
 Streuwert: 1.50, horizontal: 1.76, vertikal: 1.17

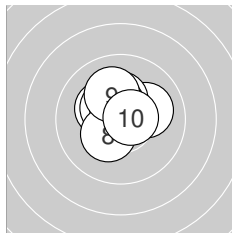
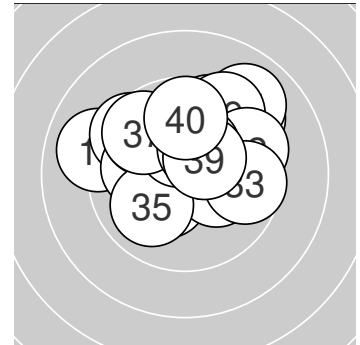

**Serie 1:**

10.3 *	10.8 *	10.1 →	10.6 *	10.3 *
10.4 *	10.4 *	10.3 *	10.1 ↑	10.6 *

beste Teiler: 43.8 (2.), 83.1 (10.), 83.4 (4.)  
 Trefferlage: 0.25 mm links, 0.72 mm hoch  
 Streuwert: 0.95, horizontal: 1.02, vertikal: 0.88

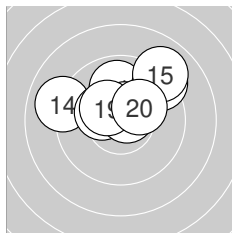

**Serie 2:**

9.9 ↑	10.6 *	9.2 ↗	9.0 ←	9.0 ↗
10.3 *	10.6 *	10.7 *	10.4 *	10.2 *

beste Teiler: 64.8 (18.), 88.3 (12.), 90.7 (17.)  
 Trefferlage: 0.14 mm rechts, 1.53 mm hoch  
 Streuwert: 1.83, horizontal: 2.32, vertikal: 1.14

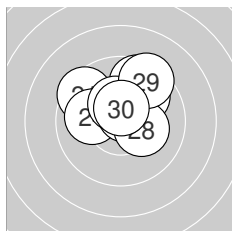

**Serie 3:**

9.5 ↘	9.9 ↗	9.6 ↑	10.0 ←	10.5 *
10.7 *	10.4 *	10.2 *	9.4 ↗	10.5 *

beste Teiler: 66.0 (26.), 101.2 (25.), 106.1 (30.)  
 Trefferlage: 0.18 mm rechts, 1.43 mm hoch  
 Streuwert: 1.48, horizontal: 1.69, vertikal: 1.23

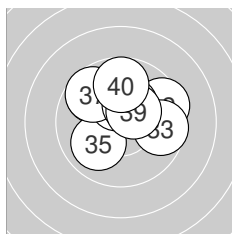

**Serie 4:**

10.2 *	9.5 →	9.6 →	9.7 ↘	10.0 ↗
10.3 *	9.7 ↘	10.3 *	10.4 *	9.7 ↑

beste Teiler: 137.7 (39.), 157.0 (36.), 158.8 (38.)  
 Trefferlage: 0.16 mm rechts, 1.24 mm hoch  
 Streuwert: 1.72, horizontal: 2.01, vertikal: 1.38



Ergebnis: **401.9** (384)  
 Serien: 101.5 98.5 101.4 100.5  
 Zähler: 25 14 1 0 0 0 0 0 0 0  
 Innenzehner: 17  
 Weitester: 613 (20.), 467 (18.), 460 (13.)  
 beste Teiler: 41.0 (7.), 55.8 (23.), 64.4 (19.)  
 Trefferlage: 0.01 mm links, 0.29 mm hoch  
 Streuwert: 1.85, horizontal: 2.16, vertikal: 1.47

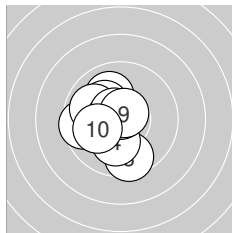
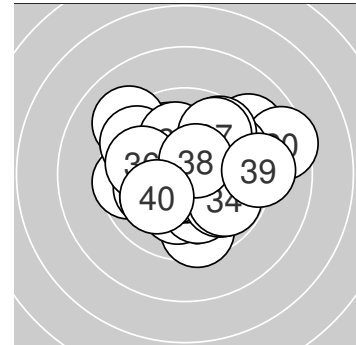

**Serie 1:**

9.6 ←	10.0 ↖	9.6 ↓	10.1 ↓	10.2 *
9.9 ↖	10.8 *	10.6 *	10.7 *	10.0 ←

beste Teiler: 41.0 (7.), 65.3 (9.), 82.7 (8.)  
 Trefferlage: 1.03 mm links, 0.08 mm tief  
 Streuwert: 1.49, horizontal: 1.31, vertikal: 1.65

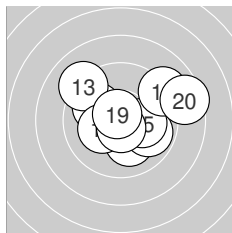

**Serie 2:**

10.0 ↖	10.1 ↓	9.1 ↖	9.9 ↘	10.2 *
10.2 *	10.7 *	9.1 ↗	10.7 *	8.5 →

beste Teiler: 64.4 (19.), 71.1 (17.), 183.8 (16.)  
 Trefferlage: 0.75 mm rechts, 0.45 mm hoch  
 Streuwert: 2.35, horizontal: 2.86, vertikal: 1.69

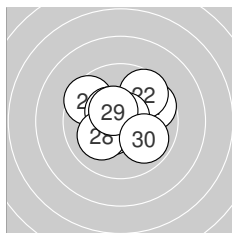

**Serie 3:**

9.7 ↗	9.7 ↗	10.7 *	10.3 *	10.5 *
9.6 ↖	10.4 *	10.1 ↙	10.5 *	9.9 ↘

beste Teiler: 55.8 (23.), 113.8 (25.), 116.2 (29.)  
 Trefferlage: 0.11 mm links, 0.39 mm hoch  
 Streuwert: 1.67, horizontal: 1.91, vertikal: 1.37

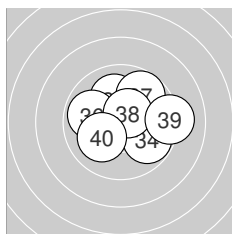

**Serie 4:**

10.3 *	10.5 *	10.4 *	9.8 ↘	10.1 ↑
9.9 ←	9.7 ↗	10.5 *	9.2 →	10.1 ↙

beste Teiler: 104.4 (38.), 104.9 (32.), 129.4 (33.)  
 Trefferlage: 0.34 mm rechts, 0.42 mm hoch  
 Streuwert: 1.79, horizontal: 2.18, vertikal: 1.27



Ergebnis: **351** (367.7)  
 Serien: 79 95 87 90  
 Zähler: 12 13 10 4 1 0 0 0 0 0  
 Innenzehner: 3  
 Weitestе: 3380 (7.), 3073 (1.), 3004 (31.)  
 beste Teiler: 306.8 (17.), 352.9 (20.), 460.6 (38.)  
 Trefferlage: 0.60 mm rechts, 6.96 mm hoch  
 Streuwert: 10.49, horizontal: 12.63, vertikal: 7.77

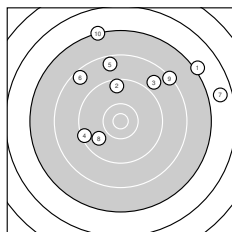
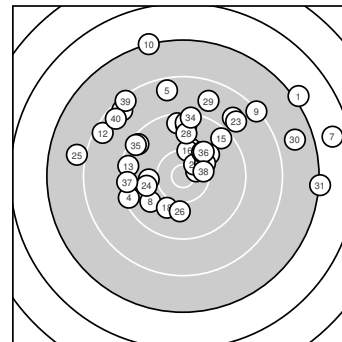

**Serie 1:**  
 7.1 ↗ 9.5 ↑ 8.9 ↗ 9.4 ← 8.6 ↑  
 8.5 ↘ 6.7 → 9.8 ↖ 8.3 ↗ 7.2 ↑  
 beste Teiler: 906.0 (8.), 1163.7 (2.), 1275.1 (4.)  
 Trefferlage: 4.04 mm rechts, 11.63 mm hoch  
 Streuwert: 13.59, horizontal: 16.18, vertikal: 10.38

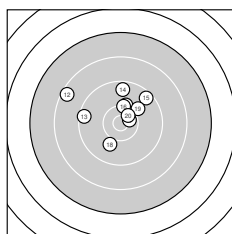

**Serie 2:**  
 10.2 ↑ 8.5 ↘ 9.4 ← 9.6 ↑ 9.5 ↗  
 10.2 ↑ 10.6 \* 10.0 ↘ 10.0 ↗ 10.5 \*  
 beste Teiler: 306.8 (17.), 352.9 (20.), 563.4 (16.)  
 Trefferlage: 1.01 mm links, 4.39 mm hoch  
 Streuwert: 6.71, horizontal: 7.99, vertikal: 5.12

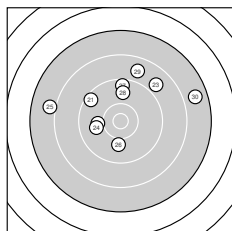

**Serie 3:**  
 9.5 ↘ 10.0 ← 8.9 ↗ 9.9 ← 8.0 ←  
 10.0 ↓ 9.5 ↑ 9.8 ↑ 8.8 ↑ 7.7 →  
 beste Teiler: 751.4 (22.), 772.0 (26.), 822.2 (24.)  
 Trefferlage: 0.60 mm links, 5.85 mm hoch  
 Streuwert: 10.56, horizontal: 12.97, vertikal: 7.40

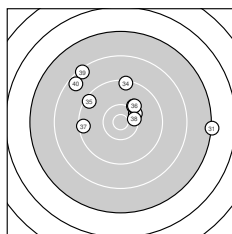

**Serie 4:**  
 7.2 → 10.3 ↗ 10.1 ↗ 9.3 ↑ 9.4 ↘  
 10.1 ↗ 9.4 ← 10.4 \* 8.4 ↘ 8.5 ↘  
 beste Teiler: 460.6 (38.), 558.7 (32.), 673.1 (33.)  
 Trefferlage: 0.00 mm, 5.97 mm hoch  
 Streuwert: 10.44, horizontal: 13.38, vertikal: 6.25



Ergebnis: **360** (379.7)  
 Serien: 91 90 87 92  
 Zähler: 12 18 8 2 0 0 0 0 0 0  
 Innenzehner: 6  
 Weitester: 2481 (26.), 2412 (32.), 2251 (21.)  
 beste Teiler: 293.5 (20.), 318.6 (36.), 377.6 (40.)  
 Trefferlage: 0.09 mm links, 2.77 mm tief  
 Streuwert: 9.28, horizontal: 8.29, vertikal: 10.17

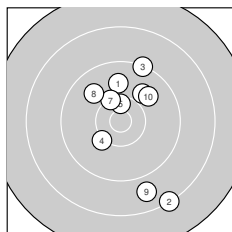
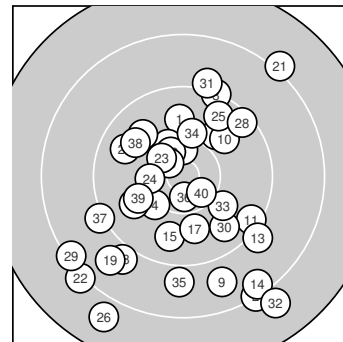

**Serie 1:**  
 9.9 ↑                      8.3 ↘                      9.3 ↑                      10.2 ↙                      10.4 \*  
 9.9 ↗                      10.3 ↖                      9.8 ↘                      8.8 ↘                      9.9 ↗  
 beste Teiler: 402.0 (5.), 541.7 (7.), 615.2 (4.)  
 Trefferlage: 2.03 mm rechts, 0.96 mm hoch  
 Streuwert: 8.43, horizontal: 5.52, vertikal: 10.56

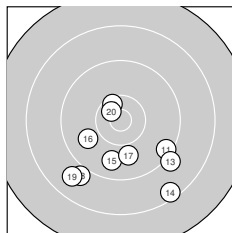

**Serie 2:**  
 9.4 ↘                      10.4 \*                      9.1 ↘                      8.4 ↘                      9.8 ↓  
 9.9 ↙                      9.9 ↓                      9.0 ↙                      8.8 ↙                      10.6 \*  
 beste Teiler: 293.5 (20.), 415.9 (12.), 827.5 (17.)  
 Trefferlage: 0.11 mm rechts, 7.43 mm tief  
 Streuwert: 7.57, horizontal: 8.54, vertikal: 6.45

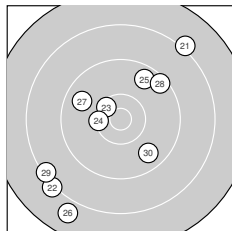

**Serie 3:**  
 8.1 ↗                      8.2 ↙                      10.4 \*                      10.3 ←                      9.6 ↗  
 7.8 ↙                      9.7 ↖                      9.4 ↗                      8.3 ↙                      9.7 ↘  
 beste Teiler: 429.9 (23.), 509.4 (24.), 981.9 (27.)  
 Trefferlage: 2.65 mm links, 1.64 mm tief  
 Streuwert: 11.72, horizontal: 11.11, vertikal: 12.29

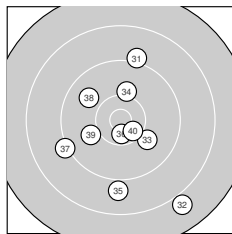

**Serie 4:**  
 9.1 ↑                      7.9 ↘                      10.0 ↘                      10.1 ↑                      8.9 ↓  
 10.6 \*                      9.2 ↙                      9.8 ↖                      10.0 ↙                      10.5 \*  
 beste Teiler: 318.6 (36.), 377.6 (40.), 673.7 (34.)  
 Trefferlage: 0.10 mm rechts, 2.98 mm tief  
 Streuwert: 8.97, horizontal: 7.66, vertikal: 10.11





Ergebnis: **349** (367.0)  
 Serien: 88 84 89 88  
 Zähler: 9 16 11 3 1 0 0 0 0 0  
 Innenzehner: 3  
 Weitester: 3552 (14.), 2811 (21.), 2610 (7.)  
 beste Teiler: 274.4 (10.), 398.5 (36.), 426.3 (1.)  
 Trefferlage: 2.38 mm links, 2.83 mm tief  
 Streuwert: 11.10, horizontal: 11.05, vertikal: 11.14

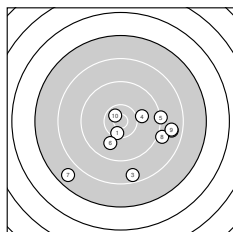
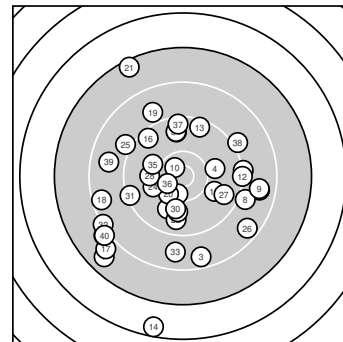

**Serie 1:**  
 10.4 \*                      8.7 →                      8.6 ↓                      10.0 →                      9.2 →  
 9.9 ↓                      7.7 ↙                      9.0 ↘                      8.7 →                      10.6 \*  
 beste Teiler: 274.4 (10.), 426.3 (1.), 761.3 (4.)  
 Trefferlage: 5.04 mm rechts, 5.54 mm tief  
 Streuwert: 9.77, horizontal: 11.53, vertikal: 7.60

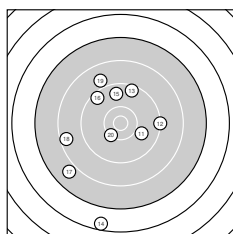

**Serie 2:**  
 9.9 ↘                      9.2 →                      9.5 ↑                      6.5 ↓                      9.7 ↑  
 9.5 ↘                      7.9 ↙                      8.5 ←                      8.9 ↖                      10.3 ↙  
 beste Teiler: 532.5 (20.), 808.6 (11.), 1032.2 (15.)  
 Trefferlage: 3.85 mm links, 1.97 mm tief  
 Streuwert: 12.91, horizontal: 10.30, vertikal: 15.08

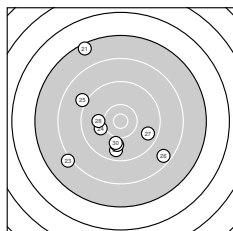

**Serie 3:**  
 7.4 ↖                      9.7 ↓                      8.1 ↙                      10.0 ←                      9.1 ↘  
 8.6 ↘                      9.7 →                      10.0 ←                      9.9 ↓                      10.0 ↓  
 beste Teiler: 735.7 (24.), 770.0 (28.), 773.6 (30.)  
 Trefferlage: 3.87 mm links, 2.57 mm tief  
 Streuwert: 10.92, horizontal: 10.23, vertikal: 11.58

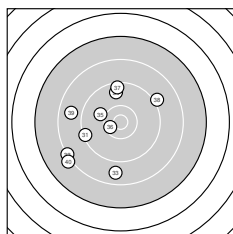

**Serie 4:**  
 9.3 ←                      8.3 ↙                      8.7 ↓                      9.6 ↑                      10.0 ↘  
 10.5 \*                      9.4 ↑                      9.1 ↘                      8.8 ←                      8.1 ↙  
 beste Teiler: 398.5 (36.), 751.1 (35.), 1046.3 (34.)  
 Trefferlage: 6.84 mm links, 1.24 mm tief  
 Streuwert: 10.10, horizontal: 9.87, vertikal: 10.32



Ergebnis: **355** (374.2)  
 Serien: 88 89 93 85  
 Zähler: 9 20 8 3 0 0 0 0 0 0  
 Innenzehner: 1  
 Weitester: 2981 (4.), 2806 (14.), 2416 (40.)  
 beste Teiler: 352.5 (29.), 493.1 (12.), 524.4 (15.)  
 Trefferlage: 0.91 mm links, 3.04 mm hoch  
 Streuwert: 9.89, horizontal: 8.79, vertikal: 10.88

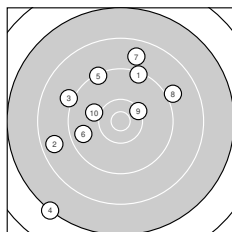
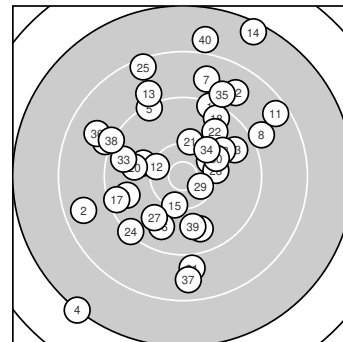

**Serie 1:**  
 9.3 ↗ 8.7 ← 9.1 ↖ 7.2 ↙ 9.3 ↘  
 9.7 ← 8.8 ↑ 9.0 → 10.3 → 10.0 ←  
 beste Teiler: 534.4 (9.), 730.8 (10.), 1032.1 (6.)  
 Trefferlage: 4.48 mm links, 2.66 mm hoch  
 Streuwert: 11.20, horizontal: 10.82, vertikal: 11.57

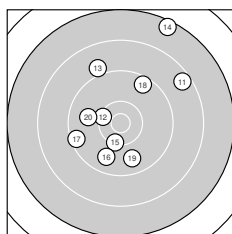

**Serie 2:**  
 8.5 ↗ 10.3 ↖ 9.0 ↘ 7.4 ↗ 10.3 ↘  
 9.8 ↘ 9.4 ← 9.5 ↗ 9.7 ↘ 9.9 ←  
 beste Teiler: 493.1 (12.), 524.4 (15.), 863.7 (20.)  
 Trefferlage: 0.14 mm rechts, 3.68 mm hoch  
 Streuwert: 10.21, horizontal: 9.05, vertikal: 11.26

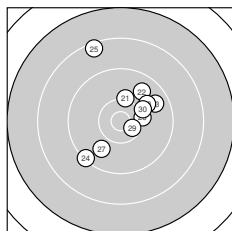

**Serie 3:**  
 10.2 ↑ 9.8 ↗ 9.7 → 9.3 ↙ 8.4 ↘  
 10.2 → 9.9 ↙ 9.9 → 10.5 \* 10.1 →  
 beste Teiler: 352.5 (29.), 583.4 (26.), 611.9 (21.)  
 Trefferlage: 1.63 mm rechts, 2.73 mm hoch  
 Streuwert: 7.29, horizontal: 6.40, vertikal: 8.07

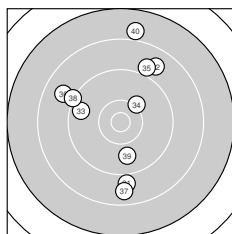

**Serie 4:**  
 8.9 ↓ 8.8 ↗ 9.6 ↖ 10.2 ↗ 9.0 ↗  
 8.9 ↖ 8.7 ↓ 9.2 ↖ 9.8 ↓ 7.9 ↑  
 beste Teiler: 622.9 (34.), 896.8 (39.), 1078.4 (33.)  
 Trefferlage: 0.94 mm links, 3.10 mm hoch  
 Streuwert: 11.37, horizontal: 8.51, vertikal: 13.65



Ergebnis: **368** (387.1)  
 Serien: 93 92 89 94  
 Zähler: 14 20 6 0 0 0 0 0 0 0  
 Innenzehner: 6  
 Weitester: 2158 (37.), 2146 (23.), 2049 (2.)  
 beste Teiler: 113.2 (40.), 155.5 (27.), 196.1 (30.)  
 Trefferlage: 0.39 mm rechts, 3.39 mm hoch  
 Streuwert: 7.84, horizontal: 7.15, vertikal: 8.48

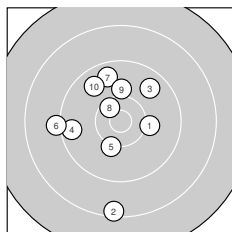
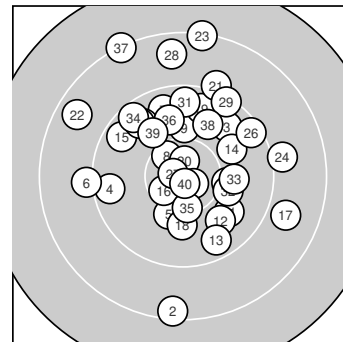

**Serie 1:**  
 10.1 → 8.4 ↓ 9.7 ↗ 9.5 ← 10.2 ↓  
 9.1 ← 9.6 ↑ 10.5 \* 10.0 ↑ 9.7 ↘  
 beste Teiler: 394.1 (8.), 615.5 (5.), 670.3 (1.)  
 Trefferlage: 2.73 mm links, 0.58 mm hoch  
 Streuwert: 7.97, horizontal: 6.73, vertikal: 9.05

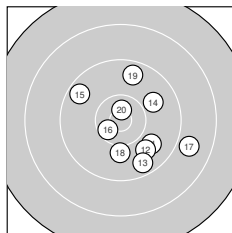

**Serie 2:**  
 9.8 ↘ 9.9 ↘ 9.6 ↓ 9.9 → 9.6 ↘  
 10.5 \* 8.9 → 10.0 ↓ 9.6 ↑ 10.7 \*  
 beste Teiler: 233.1 (20.), 362.2 (16.), 739.0 (18.)  
 Trefferlage: 3.13 mm rechts, 1.46 mm tief  
 Streuwert: 6.72, horizontal: 6.73, vertikal: 6.70

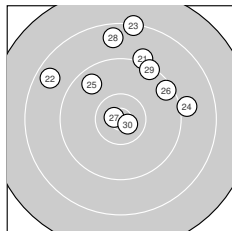

**Serie 3:**  
 9.1 ↑ 8.6 ↘ 8.3 ↑ 9.0 → 9.7 ↘  
 9.4 ↗ 10.8 \* 8.6 ↑ 9.3 ↗ 10.7 \*  
 beste Teiler: 155.5 (27.), 196.1 (30.), 1033.7 (25.)  
 Trefferlage: 1.57 mm rechts, 9.08 mm hoch  
 Streuwert: 8.11, horizontal: 8.78, vertikal: 7.37

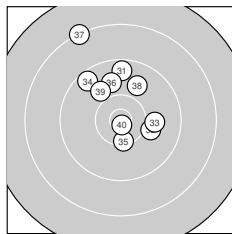

**Serie 4:**  
 9.5 ↑ 10.1 → 10.0 → 9.5 ↘ 10.3 ↓  
 9.9 ↑ 8.3 ↘ 9.9 ↑ 10.0 ↘ 10.8 \*  
 beste Teiler: 113.2 (40.), 482.3 (35.), 719.4 (32.)  
 Trefferlage: 0.39 mm links, 5.38 mm hoch  
 Streuwert: 6.62, horizontal: 5.67, vertikal: 7.44



Ergebnis: **355** (372.3)  
 Serien: 91 90 92 82  
 Zähler: 10 20 6 3 1 0 0 0 0 0  
 Innenzehner: 5  
 Weitester: 3606 (37.), 2624 (38.), 2532 (34.)  
 beste Teiler: 177.8 (15.), 319.9 (20.), 383.0 (33.)  
 Trefferlage: 1.12 mm links, 0.08 mm hoch  
 Streuwert: 10.72, horizontal: 10.96, vertikal: 10.48

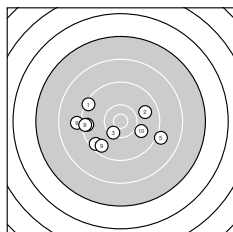
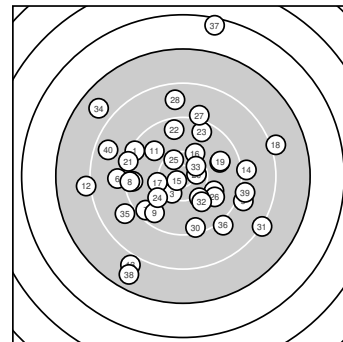

**Serie 1:**  
 9.4 ↘                      9.8 →                      10.4 \*                      9.5 ←                      9.0 →  
 9.0 ←                      9.5 ↙                      9.4 ←                      9.6 ↘                      9.9 →  
 beste Teiler: 474.9 (3.), 803.3 (10.), 919.2 (2.)  
 Trefferlage: 3.86 mm links, 2.36 mm tief  
 Streuwert: 7.99, horizontal: 10.31, vertikal: 4.61

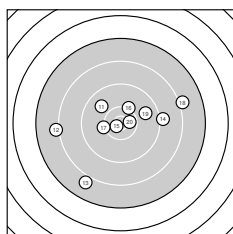

**Serie 2:**  
 9.8 ↘                      8.1 ←                      7.9 ↙                      9.1 →                      10.7 \*  
 10.2 ↗                      10.2 ←                      8.1 →                      9.8 →                      10.6 \*  
 beste Teiler: 177.8 (15.), 319.9 (20.), 605.6 (16.)  
 Trefferlage: 0.22 mm rechts, 0.15 mm tief  
 Streuwert: 10.82, horizontal: 13.06, vertikal: 7.97

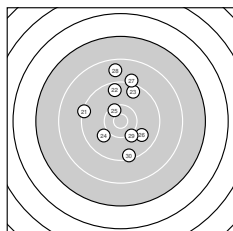

**Serie 3:**  
 9.3 ←                      9.6 ↑                      9.5 ↑                      10.0 ↙                      10.4 \*  
 9.8 ↘                      9.1 ↑                      8.7 ↑                      10.2 ↘                      9.4 ↓  
 beste Teiler: 439.7 (25.), 632.4 (29.), 777.5 (24.)  
 Trefferlage: 0.24 mm links, 3.37 mm hoch  
 Streuwert: 8.17, horizontal: 5.99, vertikal: 9.89

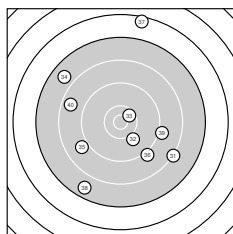

**Serie 4:**  
 8.2 ↘                      10.0 ↘                      10.5 \*                      7.8 ↘                      8.9 ↙  
 9.1 ↘                      6.4 ↑                      7.7 ↙                      9.1 →                      8.6 ←  
 beste Teiler: 383.0 (33.), 742.2 (32.), 1484.3 (36.)  
 Trefferlage: 0.62 mm links, 0.51 mm tief  
 Streuwert: 15.32, horizontal: 13.99, vertikal: 16.55



Ergebnis: **361** (379.8)  
 Serien: 86 91 90 94  
 Zähler: 15 16 6 1 2 0 0 0 0 0  
 Innenzehner: 9  
 Weitester: 3605 (22.), 3380 (4.), 2900 (10.)  
 beste Teiler: 200.0 (21.), 291.2 (3.), 307.3 (31.)  
 Trefferlage: 1.07 mm rechts, 2.79 mm tief  
 Streuwert: 9.85, horizontal: 8.84, vertikal: 10.77

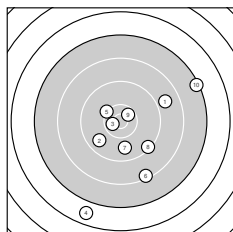
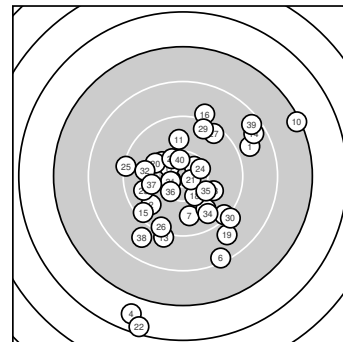

**Serie 1:**  
 8.8 ↗ 9.7 ↘ 10.6 \* 6.7 ↓ 10.2 ↘  
 8.4 ↘ 9.8 ↓ 9.3 ↘ 10.5 \* 7.3 ↗  
 beste Teiler: 291.2 (3.), 342.9 (9.), 586.4 (5.)  
 Trefferlage: 3.69 mm rechts, 5.09 mm tief  
 Streuwert: 12.26, horizontal: 11.47, vertikal: 13.00

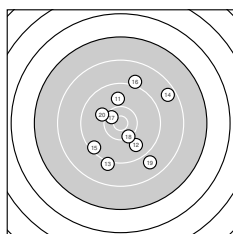

**Serie 2:**  
 9.9 ↑ 9.8 ↘ 9.1 ↓ 8.6 ↗ 9.4 ↘  
 9.1 ↗ 10.5 \* 10.3 ↘ 8.8 ↘ 10.1 ↘  
 beste Teiler: 374.4 (17.), 529.0 (18.), 704.1 (20.)  
 Trefferlage: 1.54 mm rechts, 1.03 mm tief  
 Streuwert: 9.00, horizontal: 7.88, vertikal: 10.00

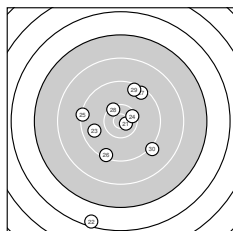

**Serie 3:**  
 10.7 \* 6.4 ↓ 9.8 ↖ 10.4 \* 9.3 ↖  
 9.4 ↓ 9.4 ↗ 10.4 \* 9.5 ↗ 9.1 ↘  
 beste Teiler: 200.0 (21.), 437.7 (24.), 475.5 (28.)  
 Trefferlage: 1.12 mm links, 3.13 mm tief  
 Streuwert: 10.97, horizontal: 8.06, vertikal: 13.24

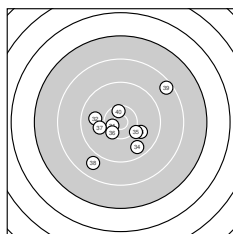

**Serie 4:**  
 10.6 \* 9.8 ↖ 10.0 ↘ 9.7 ↘ 10.2 ↘  
 10.4 \* 10.0 ↖ 8.8 ↘ 8.5 ↗ 10.5 \*  
 beste Teiler: 307.3 (31.), 384.6 (40.), 455.0 (36.)  
 Trefferlage: 0.19 mm rechts, 1.91 mm tief  
 Streuwert: 7.55, horizontal: 8.12, vertikal: 6.94



Ergebnis: **326** (344.2)  
 Serien: 75 90 80 81  
 Zähler: 3 15 10 10 1 1 0 0 0 0  
 Innenzehner: 1  
 Weitest: 4076 (8.), 3638 (32.), 3037 (10.)  
 beste Teiler: 72.5 (4.), 637.3 (13.), 771.4 (28.)  
 Trefferlage: 4.43 mm links, 0.50 mm hoch  
 Streuwert: 14.51, horizontal: 12.36, vertikal: 16.39

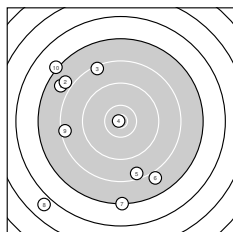
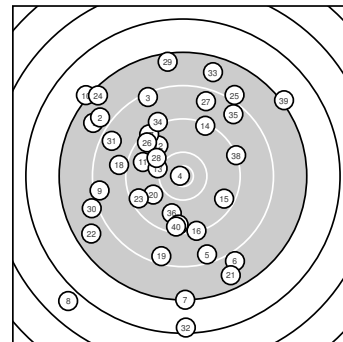

**Serie 1:**  
 7.8 ↖ 7.9 ↖ 8.4 ↗ 10.9 \* 8.5 ↓  
 8.0 ↓ 7.2 ↓ 5.9 ↗ 8.4 ← 7.2 ↖  
 beste Teiler: 72.5 (4.), 1967.1 (5.), 2033.3 (9.)  
 Trefferlage: 10.27 mm links, 3.69 mm tief  
 Streuwert: 17.17, horizontal: 14.04, vertikal: 19.81

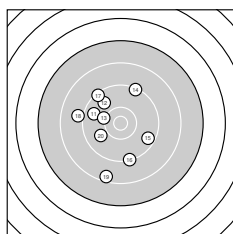

**Serie 2:**  
 9.7 ↖ 9.8 ↖ 10.2 ↖ 9.3 ↗ 9.5 ↘  
 9.3 ↓ 9.3 ↖ 9.0 ← 8.5 ↓ 9.9 ↗  
 beste Teiler: 637.3 (13.), 840.2 (20.), 944.6 (12.)  
 Trefferlage: 3.89 mm links, 0.47 mm tief  
 Streuwert: 8.95, horizontal: 7.67, vertikal: 10.07

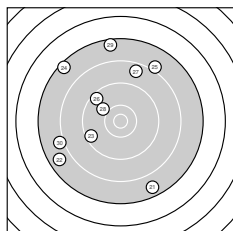

**Serie 3:**  
 7.6 ↓ 7.7 ↖ 9.5 ↖ 7.4 ↖ 8.1 ↗  
 9.5 ↖ 8.6 ↗ 10.0 ↖ 7.5 ↑ 8.0 ←  
 beste Teiler: 771.4 (28.), 1184.9 (26.), 1189.5 (23.)  
 Trefferlage: 6.42 mm links, 4.62 mm hoch  
 Streuwert: 15.06, horizontal: 13.03, vertikal: 16.84

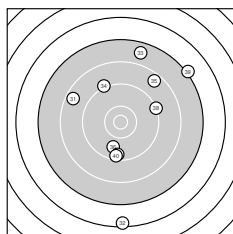

**Serie 4:**  
 8.6 ↖ 6.4 ↓ 7.7 ↑ 9.2 ↖ 8.6 ↗  
 9.8 ↓ 9.5 ↓ 9.2 → 7.2 ↗ 9.4 ↓  
 beste Teiler: 931.3 (36.), 1168.7 (37.), 1222.3 (40.)  
 Trefferlage: 2.85 mm rechts, 1.55 mm hoch  
 Streuwert: 15.49, horizontal: 11.60, vertikal: 18.58



Ergebnis: **346** (363.0)  
 Serien: 83 85 91 87  
 Zähler: 7 17 12 3 1 0 0 0 0 0  
 Innenzehner: 2  
 Weitest: 3489 (6.), 3034 (20.), 2538 (16.)  
 beste Teiler: 266.1 (14.), 278.6 (29.), 598.0 (33.)  
 Trefferlage: 2.31 mm rechts, 3.51 mm tief  
 Streuwert: 11.43, horizontal: 12.39, vertikal: 10.38

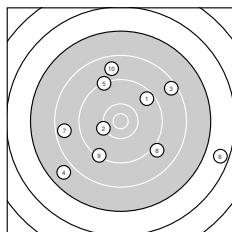
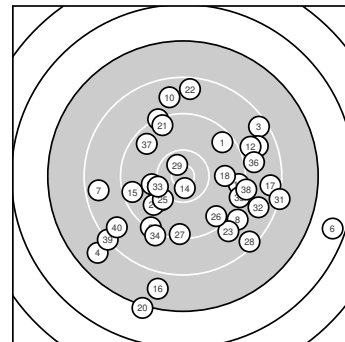

**Serie 1:**  
 9.5 ↗ 10.2 ← 8.5 ↗ 7.8 ↙ 9.2 ↖  
 6.6 ↘ 8.6 ← 9.0 ↘ 9.3 ↙ 8.8 ↑  
 beste Teiler: 614.4 (2.), 1143.7 (1.), 1329.5 (9.)  
 Trefferlage: 1.18 mm rechts, 0.64 mm tief  
 Streuwert: 14.28, horizontal: 16.29, vertikal: 11.92

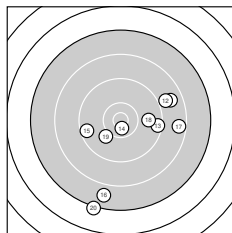

**Serie 2:**  
 8.7 ↗ 8.9 ↗ 9.4 → 10.6 \* 9.5 ←  
 7.8 ↓ 8.5 → 9.8 → 10.0 ↙ 7.2 ↓  
 beste Teiler: 266.1 (14.), 724.1 (19.), 924.0 (18.)  
 Trefferlage: 4.20 mm rechts, 5.58 mm tief  
 Streuwert: 11.70, horizontal: 11.46, vertikal: 11.94

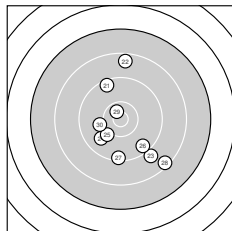

**Serie 3:**  
 9.4 ↖ 8.5 ↑ 9.0 ↘ 9.8 ↙ 10.1 ←  
 9.5 ↘ 9.4 ↓ 8.4 ↘ 10.6 \* 10.1 ←  
 beste Teiler: 278.6 (29.), 674.8 (25.), 709.6 (30.)  
 Trefferlage: 0.92 mm rechts, 2.84 mm tief  
 Streuwert: 9.35, horizontal: 7.40, vertikal: 10.96

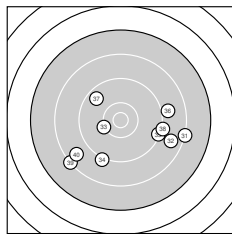

**Serie 4:**  
 8.2 → 8.7 → 10.2 ← 9.2 ↓ 9.3 →  
 9.0 → 9.6 ↖ 9.2 → 8.2 ↙ 8.7 ↙  
 beste Teiler: 598.0 (33.), 1068.0 (37.), 1331.8 (35.)  
 Trefferlage: 2.92 mm rechts, 4.98 mm tief  
 Streuwert: 11.22, horizontal: 14.36, vertikal: 6.76



Ergebnis: **355** (374.7)  
 Serien: 92 83 90 90  
 Zähler: 11 19 7 1 1 1 0 0 0 0  
 Innenzehner: 6  
 Weitester: 4249 (15.), 3255 (13.), 2521 (38.)  
 beste Teiler: 219.6 (39.), 226.3 (25.), 390.2 (4.)  
 Trefferlage: 0.02 mm links, 4.09 mm hoch  
 Streuwert: 10.32, horizontal: 9.74, vertikal: 10.87

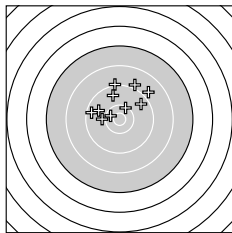
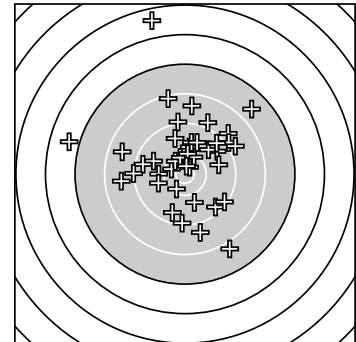

**Serie 1:**  
 8.9 ↗ 9.6 ↗ 9.0 ↗ 10.5 \* 9.2 ↑  
 10.1 ← 10.3 ↗ 9.7 ↑ 9.8 ↖ 9.5 ←  
 beste Teiler: 390.2 (4.), 518.8 (7.), 710.0 (6.)  
 Trefferlage: 0.62 mm links, 6.70 mm hoch  
 Streuwert: 6.53, horizontal: 7.67, vertikal: 5.14

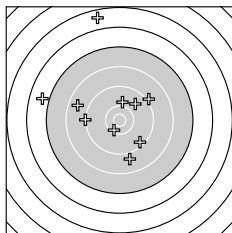

**Serie 2:**  
 8.9 ↓ 9.4 ↘ 6.9 ↖ 9.8 ↗ 5.6 ↑  
 10.0 ↑ 9.1 ↗ 10.4 \* 8.7 ↖ 9.2 ←  
 beste Teiler: 462.6 (18.), 743.1 (16.), 916.5 (14.)  
 Trefferlage: 4.17 mm links, 5.03 mm hoch  
 Streuwert: 14.42, horizontal: 13.52, vertikal: 15.28

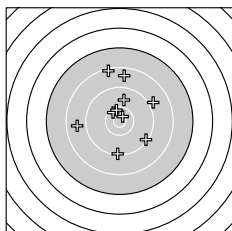

**Serie 3:**  
 8.6 ↑ 10.4 \* 8.8 ← 9.3 ↓ 10.7 \*  
 9.9 ↑ 8.3 ↑ 9.0 ↗ 9.3 ↘ 10.4 \*  
 beste Teiler: 226.3 (25.), 437.6 (22.), 465.5 (30.)  
 Trefferlage: 0.26 mm rechts, 4.22 mm hoch  
 Streuwert: 9.48, horizontal: 8.40, vertikal: 10.45

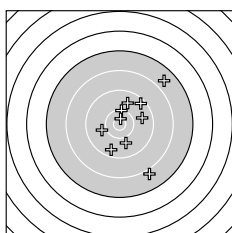

**Serie 4:**  
 8.0 ↘ 10.3 ↑ 10.0 ← 9.5 ↗ 9.9 ↓  
 9.8 ↑ 9.8 → 7.8 ↗ 10.7 \* 9.6 ↓  
 beste Teiler: 219.6 (39.), 555.8 (32.), 757.6 (33.)  
 Trefferlage: 4.42 mm rechts, 0.40 mm hoch  
 Streuwert: 9.40, horizontal: 7.57, vertikal: 10.93





Ergebnis: **344** (360.1)  
 Serien: 89 86 87 82  
 Zähler: 9 14 10 6 1 0 0 0 0 0  
 Innenzehner: 3  
 Weitester: 3499 (7.), 3058 (39.), 2823 (20.)  
 beste Teiler: 126.1 (10.), 274.5 (13.), 464.6 (29.)  
 Trefferlage: 3.22 mm rechts, 9.10 mm hoch  
 Streuwert: 10.54, horizontal: 10.79, vertikal: 10.29

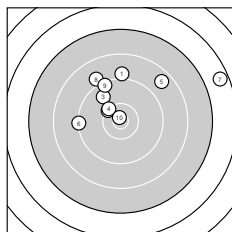
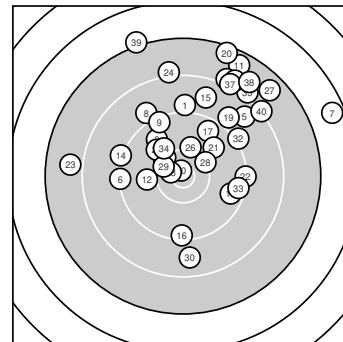

**Serie 1:**  
 9.0 ↑                      10.3 ↘                      9.7 ↘                      10.3 ↘                      8.6 ↗  
 9.3 ←                      6.6 →                      9.0 ↘                      9.4 ↘                      10.8 \*  
 beste Teiler: 126.1 (10.), 531.9 (2.), 554.5 (4.)  
 Trefferlage: 0.55 mm rechts, 8.31 mm hoch  
 Streuwert: 10.16, horizontal: 13.11, vertikal: 5.87

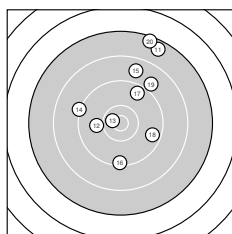

**Serie 2:**  
 7.6 ↗                      10.0 ←                      10.6 \*                      9.2 ↖                      8.7 ↑  
 9.4 ↓                      9.6 ↗                      9.6 →                      8.9 ↗                      7.4 ↑  
 beste Teiler: 274.5 (13.), 780.4 (12.), 1097.4 (18.)  
 Trefferlage: 2.80 mm rechts, 7.79 mm hoch  
 Streuwert: 10.74, horizontal: 8.58, vertikal: 12.54

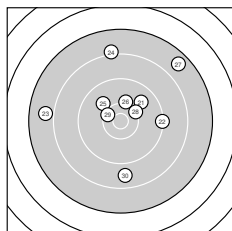

**Serie 3:**  
 9.8 ↗                      9.3 →                      7.9 ←                      8.1 ↑                      9.9 ↘  
 10.1 ↑                      7.7 ↗                      10.2 ↗                      10.4 \*                      8.7 ↓  
 beste Teiler: 464.6 (29.), 571.9 (28.), 644.4 (26.)  
 Trefferlage: 0.97 mm rechts, 4.89 mm hoch  
 Streuwert: 11.28, horizontal: 11.77, vertikal: 10.77

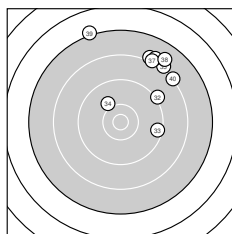

**Serie 4:**  
 8.1 ↗                      9.1 ↗                      9.4 →                      10.0 ↘                      8.1 ↗  
 8.0 ↗                      8.2 ↗                      7.8 ↗                      7.1 ↘                      8.2 ↗  
 beste Teiler: 726.7 (34.), 1225.2 (33.), 1444.4 (32.)  
 Trefferlage: 8.57 mm rechts, 15.42 mm hoch  
 Streuwert: 8.92, horizontal: 8.65, vertikal: 9.17



Ergebnis: **363** (383.7)  
 Serien: 91 91 89 92  
 Zähler: 11 21 8 0 0 0 0 0 0 0  
 Innenzehner: 7  
 Weitester: 1906 (14.), 1905 (25.), 1888 (11.)  
 beste Teiler: 106.4 (32.), 251.0 (39.), 322.5 (8.)  
 Trefferlage: 0.96 mm links, 0.65 mm tief  
 Streuwert: 8.49, horizontal: 7.78, vertikal: 9.14

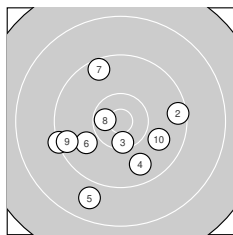
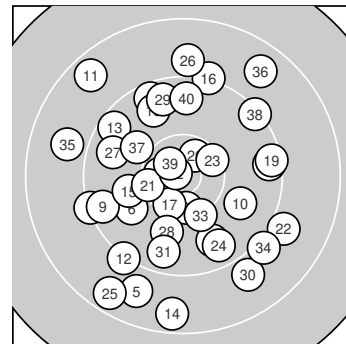

**Serie 1:**  
 9.3 ←                      9.4 →                      10.4 \*                      9.7 ↓                      8.8 ↓  
 9.9 ←                      9.5 ↗                      10.5 \*                      9.5 ←                      9.9 ↘  
 beste Teiler: 322.5 (8.), 440.3 (3.), 839.3 (6.)  
 Trefferlage: 2.07 mm links, 3.32 mm tief  
 Streuwert: 7.52, horizontal: 8.08, vertikal: 6.91

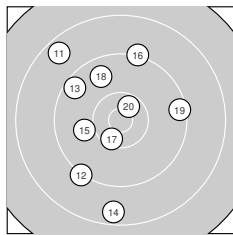

**Serie 2:**  
 8.6 ↘                      9.2 ↙                      9.5 ↘                      8.6 ↓                      10.0 ←  
 9.2 ↑                      10.4 \*                      9.7 ↗                      9.4 →                      10.5 \*  
 beste Teiler: 328.6 (20.), 430.2 (17.), 778.2 (15.)  
 Trefferlage: 2.78 mm links, 1.19 mm hoch  
 Streuwert: 9.12, horizontal: 7.35, vertikal: 10.60

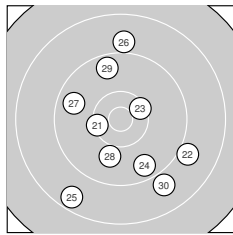

**Serie 3:**  
 10.3 ←                      9.0 ↘                      10.4 \*                      9.6 ↓                      8.6 ↙  
 8.9 ↑                      9.7 ←                      9.9 ↓                      9.6 ↑                      8.9 ↘  
 beste Teiler: 464.4 (23.), 499.6 (21.), 801.3 (28.)  
 Trefferlage: 0.30 mm rechts, 2.34 mm tief  
 Streuwert: 9.22, horizontal: 7.80, vertikal: 10.45

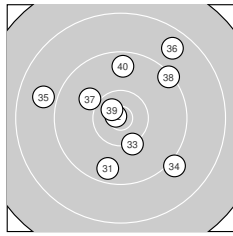

**Serie 4:**  
 9.6 ↓                      10.8 \*                      10.2 ↓                      9.1 ↓                      8.9 ←  
 8.7 ↗                      10.0 ↘                      9.3 ↗                      10.6 \*                      9.6 ↑  
 beste Teiler: 106.4 (32.), 251.0 (39.), 590.2 (33.)  
 Trefferlage: 0.69 mm rechts, 1.86 mm hoch  
 Streuwert: 8.45, horizontal: 8.49, vertikal: 8.42



Ergebnis: **359** (379.1)  
 Serien: 89 88 94 88  
 Zähler: 9 22 8 1 0 0 0 0 0  
 Innenzehner: 3  
 Weitester: 2614 (14.), 2309 (17.), 2077 (38.)  
 beste Teiler: 315.4 (2.), 316.6 (26.), 475.8 (8.)  
 Trefferlage: 0.37 mm rechts, 2.31 mm tief  
 Streuwert: 9.17, horizontal: 9.09, vertikal: 9.24

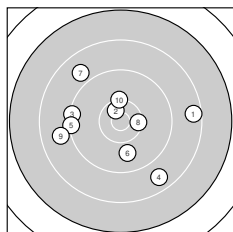
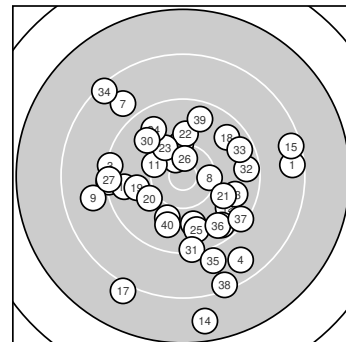

**Serie 1:**  
 8.5 → 10.6 \* 9.3 ← 8.7 ↓ 9.3 ←  
 9.9 ↓ 8.9 ↘ 10.4 \* 8.9 ← 10.2 ↑  
 beste Teiler: 315.4 (2.), 475.8 (8.), 579.2 (10.)  
 Trefferlage: 1.82 mm links, 0.32 mm tief  
 Streuwert: 9.79, horizontal: 11.53, vertikal: 7.66

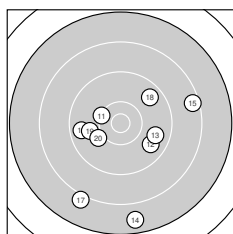

**Serie 2:**  
 10.3 ↖ 9.7 ↘ 9.7 → 7.7 ↓ 8.4 →  
 9.6 ← 8.1 ↙ 9.6 ↗ 9.9 ← 10.1 ↖  
 beste Teiler: 550.0 (11.), 716.1 (20.), 848.6 (19.)  
 Trefferlage: 0.79 mm rechts, 4.87 mm tief  
 Streuwert: 10.39, horizontal: 10.26, vertikal: 10.52

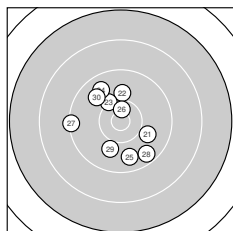

**Serie 3:**  
 9.9 ↘ 10.0 ↑ 10.2 ↘ 9.7 ↘ 9.7 ↓  
 10.6 \* 9.3 ← 9.6 ↘ 10.0 ↓ 9.8 ↘  
 beste Teiler: 316.6 (26.), 599.0 (23.), 757.3 (22.)  
 Trefferlage: 1.34 mm links, 0.07 mm hoch  
 Streuwert: 6.61, horizontal: 6.23, vertikal: 6.97

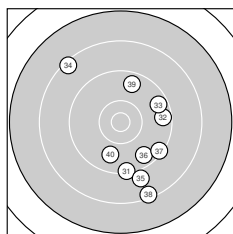

**Serie 4:**  
 9.3 ↓ 9.5 → 9.6 ↗ 8.4 ↘ 9.0 ↓  
 9.6 ↘ 9.3 ↘ 8.4 ↓ 9.6 ↑ 9.8 ↓  
 beste Teiler: 909.5 (40.), 1062.4 (39.), 1078.2 (36.)  
 Trefferlage: 3.87 mm rechts, 4.12 mm tief  
 Streuwert: 9.72, horizontal: 7.65, vertikal: 11.42



Ergebnis: **359** (379.2)  
 Serien: 87 94 90 88  
 Zähler: 13 15 10 2 0 0 0 0 0 0  
 Innenezehner: 8  
 Weitester: 2476 (4.), 2439 (22.), 2388 (27.)  
 beste Teiler: 89.8 (31.), 119.4 (23.), 252.0 (20.)  
 Trefferlage: 2.70 mm links, 2.52 mm hoch  
 Streuwert: 9.32, horizontal: 7.98, vertikal: 10.50

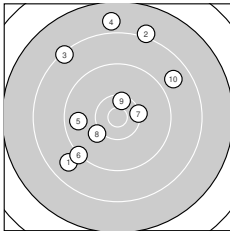
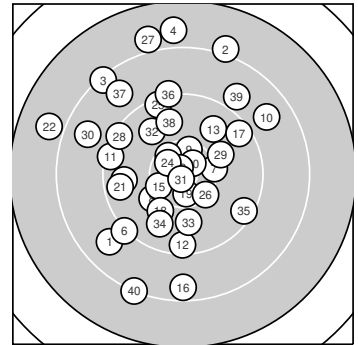

**Serie 1:**  
 8.8 ↙ 8.1 ↑ 8.3 ↘ 7.9 ↑ 9.7 ←  
 9.2 ↙ 10.3 → 10.1 ↙ 10.4 \* 8.8 ↘  
 beste Teiler: 433.4 (9.), 546.3 (7.), 676.2 (8.)  
 Trefferlage: 2.53 mm links, 5.07 mm hoch  
 Streuwert: 11.17, horizontal: 9.47, vertikal: 12.64

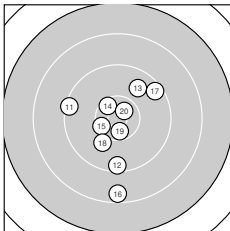

**Serie 2:**  
 9.4 ← 9.4 ↓ 9.8 ↗ 10.4 \* 10.4 \*  
 8.5 ↓ 9.5 ↗ 10.0 ↙ 10.5 \* 10.6 \*  
 beste Teiler: 252.0 (20.), 339.3 (19.), 404.9 (14.)  
 Trefferlage: 0.59 mm links, 2.04 mm tief  
 Streuwert: 7.39, horizontal: 5.90, vertikal: 8.63

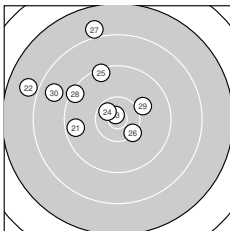

**Serie 3:**  
 9.6 ← 7.9 ← 10.8 \* 10.5 \* 9.4 ↑  
 10.3 ↘ 8.0 ↑ 9.4 ↘ 10.0 → 8.7 ←  
 beste Teiler: 119.4 (23.), 325.0 (24.), 523.8 (26.)  
 Trefferlage: 6.40 mm links, 5.73 mm hoch  
 Streuwert: 8.43, horizontal: 9.06, vertikal: 7.74

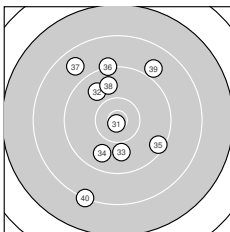

**Serie 4:**  
 10.8 \* 9.8 ↘ 9.9 ↓ 9.8 ↙ 9.4 ↘  
 9.2 ↑ 8.7 ↘ 9.8 ↑ 8.9 ↗ 8.2 ↙  
 beste Teiler: 89.8 (31.), 829.6 (33.), 905.9 (32.)  
 Trefferlage: 1.30 mm links, 1.32 mm hoch  
 Streuwert: 9.67, horizontal: 6.86, vertikal: 11.82



Ergebnis: **361** (379.4)  
 Serien: 89 95 90 87  
 Zähler: 16 12 9 3 0 0 0 0 0 0  
 Innenzehner: 10  
 Weitester: 2786 (38.), 2674 (5.), 2516 (3.)  
 beste Teiler: 100.4 (11.), 205.0 (16.), 278.7 (14.)  
 Trefferlage: 2.08 mm rechts, 0.45 mm hoch  
 Streuwert: 9.84, horizontal: 9.14, vertikal: 10.50

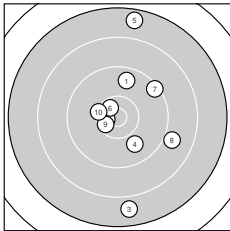
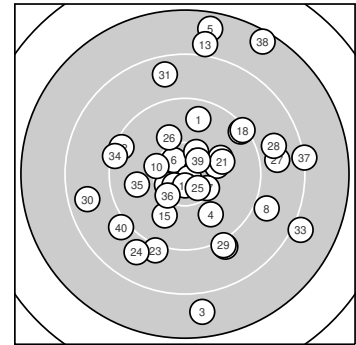

**Serie 1:**  
 9.7 ↑                      10.6 \*                      7.8 ↓                      9.9 ↘                      7.6 ↑  
 10.5 \*                      9.4 ↗                      8.9 ↘                      10.5 \*                      10.3 ←  
 beste Teiler: 300.4 (2.), 325.3 (6.), 380.7 (9.)  
 Trefferlage: 2.63 mm rechts, 0.70 mm hoch  
 Streuwert: 10.38, horizontal: 6.33, vertikal: 13.24

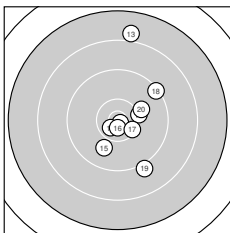

**Serie 2:**  
 10.8 \*                      10.2 →                      8.0 ↑                      10.6 \*                      9.9 ↘  
 10.7 \*                      10.4 \*                      9.3 ↗                      9.1 ↘                      10.1 →  
 beste Teiler: 100.4 (11.), 205.0 (16.), 278.7 (14.)  
 Trefferlage: 3.28 mm rechts, 0.80 mm hoch  
 Streuwert: 7.62, horizontal: 4.44, vertikal: 9.82

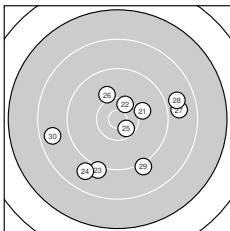

**Serie 3:**  
 10.1 →                      10.4 \*                      9.1 ↓                      8.9 ↘                      10.5 \*  
 10.0 ↘                      8.8 →                      8.8 →                      9.1 ↘                      8.7 ←  
 beste Teiler: 342.5 (25.), 450.7 (22.), 714.0 (21.)  
 Trefferlage: 1.62 mm rechts, 2.72 mm tief  
 Streuwert: 9.59, horizontal: 10.78, vertikal: 8.22

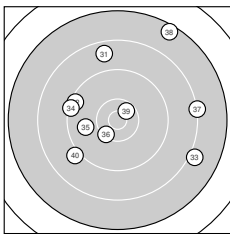

**Serie 4:**  
 8.6 ↑                      9.4 ↘                      8.0 ↘                      9.3 ↘                      9.8 ←  
 10.3 ↘                      8.2 →                      7.5 ↑                      10.5 \*                      9.1 ↘  
 beste Teiler: 342.3 (39.), 498.9 (36.), 890.2 (35.)  
 Trefferlage: 0.78 mm rechts, 3.03 mm hoch  
 Streuwert: 12.27, horizontal: 13.47, vertikal: 10.94



Ergebnis: **368** (385.7)  
 Serien: 94 91 92 91  
 Zähler: 17 15 7 1 0 0 0 0 0 0  
 Innenzehner: 6  
 Weitester: 2497 (26.), 2235 (40.), 1954 (18.)  
 beste Teiler: 148.8 (4.), 351.5 (19.), 357.2 (37.)  
 Trefferlage: 2.68 mm links, 3.23 mm tief  
 Streuwert: 7.98, horizontal: 7.41, vertikal: 8.50

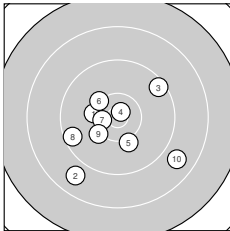
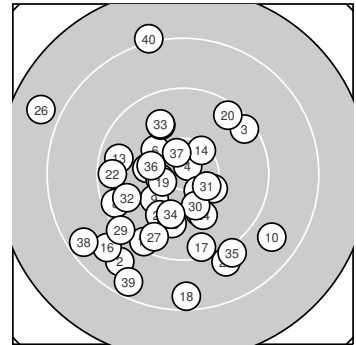

**Serie 1:**

10.2 ←	8.8 ↙	9.4 ↗	10.8 *	10.1 ↘
10.2 ↘	10.5 *	9.5 ←	10.2 ↙	8.8 ↘

beste Teiler: 148.8 (4.), 375.8 (7.), 584.4 (1.)  
 Trefferlage: 1.19 mm links, 2.61 mm tief  
 Streuwert: 7.35, horizontal: 8.16, vertikal: 6.44

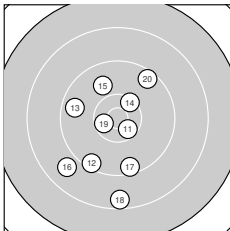

**Serie 2:**

10.5 *	9.4 ↙	9.6 ←	10.3 ↗	9.9 ↘
8.8 ↙	9.4 ↓	8.5 ↓	10.5 *	9.5 ↗

beste Teiler: 351.5 (19.), 358.7 (11.), 481.0 (14.)  
 Trefferlage: 1.94 mm links, 3.40 mm tief  
 Streuwert: 8.13, horizontal: 6.26, vertikal: 9.64

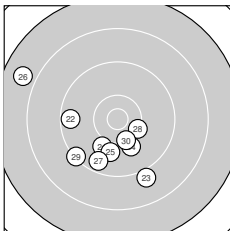

**Serie 3:**

10.0 ↙	9.5 ←	9.0 ↓	10.0 ↓	9.9 ↓
7.8 ↘	9.6 ↙	10.3 ↘	9.3 ↙	10.3 ↓

beste Teiler: 538.0 (28.), 543.3 (30.), 732.1 (24.)  
 Trefferlage: 3.70 mm links, 5.10 mm tief  
 Streuwert: 7.94, horizontal: 9.01, vertikal: 6.70

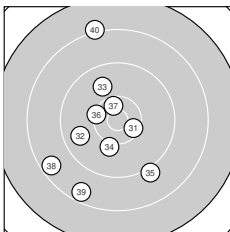

**Serie 4:**

10.4 *	9.7 ←	9.8 ↘	10.1 ↓	9.1 ↓
10.3 ←	10.5 *	8.5 ↙	8.5 ↙	8.2 ↗

beste Teiler: 357.2 (37.), 425.3 (31.), 526.8 (36.)  
 Trefferlage: 3.90 mm links, 1.83 mm tief  
 Streuwert: 9.29, horizontal: 6.72, vertikal: 11.29



Ergebnis: **371** (390.3)  
 Serien: 90 93 95 93  
 Zähler: 15 21 4 0 0 0 0 0 0 0  
 Innenzehner: 4  
 Weitester: 2147 (6.), 1890 (4.), 1691 (15.)  
 beste Teiler: 219.2 (9.), 381.8 (25.), 429.1 (21.)  
 Trefferlage: 0.16 mm rechts, 2.88 mm hoch  
 Streuwert: 7.15, horizontal: 6.43, vertikal: 7.80

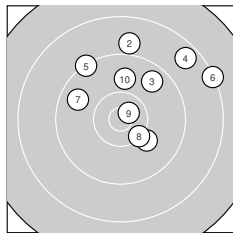
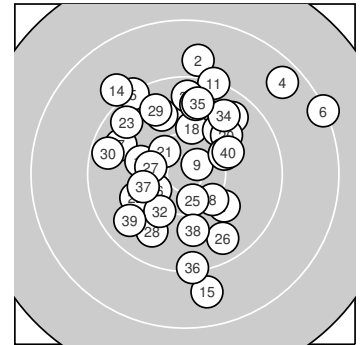

**Serie 1:**  
 10.1 ↘                      8.9 ↑                      9.6 ↗  
    8.3 ↗                      9.7 ↖                      10.3 ↘  
 beste Teiler: 219.2 (9.), 530.8 (8.), 713.7 (1.)  
 Trefferlage: 3.75 mm rechts, 6.33 mm hoch  
 Streuwert: 7.77, horizontal: 8.58, vertikal: 6.86

8.6 ↗                      9.3 ↘  
 10.7 \*                      9.9 ↗

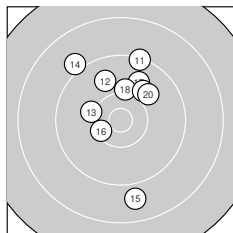

**Serie 2:**  
 9.3 ↑                      9.8 ↘                      10.1 ↖  
 10.4 \*                      9.8 ↗                      10.1 ↑  
 beste Teiler: 470.7 (16.), 648.2 (13.), 658.0 (18.)  
 Trefferlage: 0.07 mm links, 4.22 mm hoch  
 Streuwert: 7.14, horizontal: 5.36, vertikal: 8.55

9.0 ↘                      8.8 ↓  
 10.0 ↗                      9.9 ↗

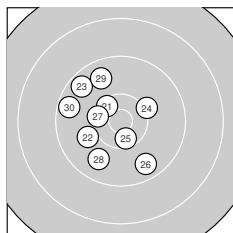

**Serie 3:**  
 10.4 \*                      10.0 ↖                      9.6 ↘  
    9.6 ↘                      10.3 ↖                      9.8 ↗  
 beste Teiler: 381.8 (25.), 429.1 (21.), 493.4 (27.)  
 Trefferlage: 3.05 mm links, 0.23 mm hoch  
 Streuwert: 5.81, horizontal: 5.50, vertikal: 6.10

10.2 ↗                      10.5 \*  
 9.7 ↘                      9.5 ↖

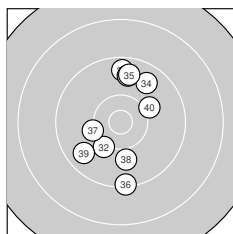

**Serie 4:**  
 9.6 ↑                      10.2 ↗                      9.7 ↑  
    9.3 ↓                      10.2 ↖                      9.9 ↓  
 beste Teiler: 615.0 (37.), 634.5 (32.), 685.1 (40.)  
 Trefferlage: 0.02 mm rechts, 0.76 mm hoch  
 Streuwert: 7.02, horizontal: 4.52, vertikal: 8.84

9.7 ↗                      9.7 ↑  
 9.7 ↗                      10.1 ↗



Ergebnis: **371** (390.5)  
 Serien: 97 90 92 92  
 Zähler: 16 19 5 0 0 0 0 0 0 0  
 Innenzehner: 10  
 Weitester: 1968 (39.), 1950 (16.), 1935 (29.)  
 beste Teiler: 146.4 (15.), 158.0 (1.), 198.9 (21.)  
 Trefferlage: 2.35 mm links, 2.17 mm hoch  
 Streuwert: 7.49, horizontal: 7.26, vertikal: 7.71

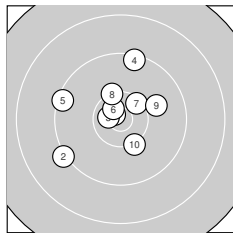
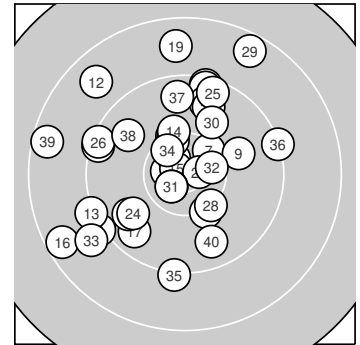

**Serie 1:**  
 10.8 \*                      9.2 ↙                      10.6 \*                      9.4 ↑                      9.4 ↖  
 10.6 \*                      10.4 \*                      10.3 ↑                      10.0 →                      10.2 ↘  
 beste Teiler: 158.0 (1.), 256.1 (3.), 264.6 (6.)  
 Trefferlage: 1.45 mm links, 1.83 mm hoch  
 Streuwert: 5.96, horizontal: 6.35, vertikal: 5.54

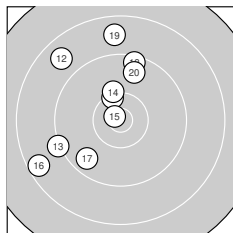

**Serie 2:**  
 10.3 ↑                      8.7 ↘                      9.2 ↙                      10.2 ↑                      10.8 \*  
 8.5 ↙                      9.6 ↙                      9.4 ↑                      8.7 ↑                      9.7 ↑  
 beste Teiler: 146.4 (15.), 498.1 (11.), 613.8 (14.)  
 Trefferlage: 4.95 mm links, 4.12 mm hoch  
 Streuwert: 8.30, horizontal: 7.01, vertikal: 9.41

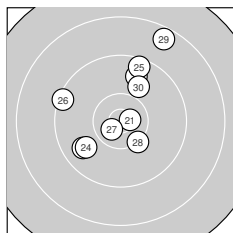

**Serie 3:**  
 10.7 \*                      9.7 ↙                      9.7 ↑                      9.8 ↙                      9.5 ↑  
 9.3 ↖                      10.6 \*                      10.2 ↘                      8.5 ↑                      9.9 ↑  
 beste Teiler: 198.9 (21.), 251.9 (27.), 564.5 (28.)  
 Trefferlage: 0.34 mm links, 3.26 mm hoch  
 Streuwert: 7.29, horizontal: 6.66, vertikal: 7.87

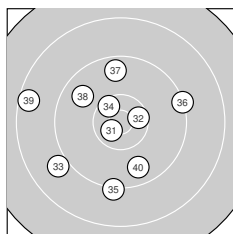

**Serie 4:**  
 10.6 \*                      10.5 \*                      9.0 ↙                      10.4 \*                      9.2 ↓  
 9.3 →                      9.6 ↑                      9.8 ↘                      8.5 ↖                      9.7 ↘  
 beste Teiler: 256.2 (31.), 384.1 (32.), 411.8 (34.)  
 Trefferlage: 2.66 mm links, 0.52 mm tief  
 Streuwert: 8.50, horizontal: 9.04, vertikal: 7.91





Ergebnis: **373.7** (358)  
 Serien: 94.7 90.7 91.8 96.5  
 Zähler: 13 16 7 4 0 0 0 0 0 0  
 Innenzehner: 8  
 Weitestе: 886 (21.), 817 (15.), 809 (38.)  
 beste Teiler: 136.7 (39.), 138.1 (9.), 176.9 (10.)  
 Trefferlage: 0.01 mm links, 0.94 mm tief  
 Streuwert: 3.19, horizontal: 3.69, vertikal: 2.59

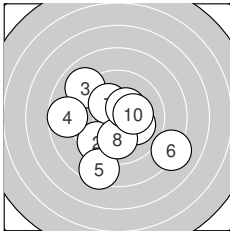
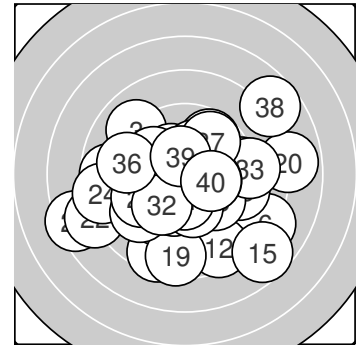

**Serie 1:**

10.1 ↘	9.5 ↙	9.0 ↘	8.7 ←	8.5 ↓
8.1 ↘	10.2 *	10.0 ↓	10.4 *	10.2 *

beste Teiler: 138.1 (9.), 176.9 (10.), 182.2 (7.)  
 Trefferlage: 0.39 mm links, 0.91 mm tief  
 Streuwert: 3.01, horizontal: 3.28, vertikal: 2.72

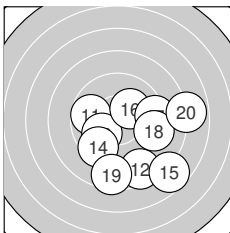

**Serie 2:**

9.7 ←	8.6 ↓	10.0 ↙	9.5 ↙	7.7 ↘
10.2 *	9.3 →	9.3 →	8.5 ↓	7.9 →

beste Teiler: 188.9 (16.), 227.9 (13.), 304.1 (11.)  
 Trefferlage: 1.79 mm rechts, 1.96 mm tief  
 Streuwert: 3.30, horizontal: 3.63, vertikal: 2.92

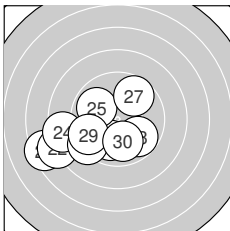

**Serie 3:**

7.4 ←	8.0 ←	10.0 ↓	8.4 ←	9.9 ↖
9.2 ↙	9.7 ↗	9.8 ↘	9.5 ↙	9.9 ↓

beste Teiler: 249.5 (23.), 252.9 (30.), 265.8 (25.)  
 Trefferlage: 2.60 mm links, 1.55 mm tief  
 Streuwert: 2.91, horizontal: 3.61, vertikal: 1.97

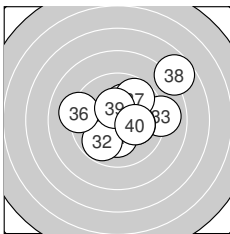

**Serie 4:**

10.2 *	9.8 ↙	9.0 →	10.1 →	10.2 *
9.2 ←	9.7 ↗	7.7 ↗	10.4 *	10.2 *

beste Teiler: 136.7 (39.), 190.0 (31.), 193.4 (35.)  
 Trefferlage: 1.12 mm rechts, 0.67 mm hoch  
 Streuwert: 2.64, horizontal: 3.06, vertikal: 2.16



Ergebnis: **394.6** (377)  
 Serien: 98.0 99.8 100.3 96.5  
 Zähler: 20 17 3 0 0 0 0 0 0 0  
 Innenzehner: 14  
 Weitestе: 641 (6.), 626 (40.), 590 (7.)  
 beste Teiler: 32.3 (2.), 84.0 (8.), 115.0 (1.)  
 Trefferlage: 0.49 mm links, 0.34 mm hoch  
 Streuwert: 2.12, horizontal: 2.37, vertikal: 1.83

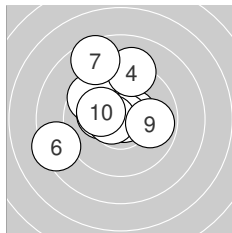
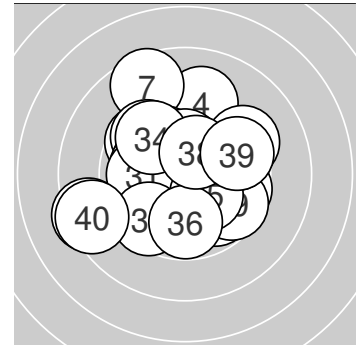

**Serie 1:**

10.5 *	10.8 *	9.6 ↘	9.2 ↑	10.2 *
8.4 ↙	8.6 ↖	10.6 *	9.9 →	10.2 *

beste Teiler: 32.3 (2.), 84.0 (8.), 115.0 (1.)  
 Trefferlage: 1.02 mm links, 1.05 mm hoch  
 Streuwert: 2.38, horizontal: 2.44, vertikal: 2.32

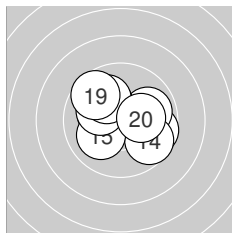

**Serie 2:**

9.7 →	10.2 *	9.9 →	9.7 ↘	10.1 ↙
10.2 *	10.1 ↖	10.0 ↖	9.7 ↘	10.2 *

beste Teiler: 182.7 (12.), 189.1 (20.), 191.4 (16.)  
 Trefferlage: 0.00 mm, 0.41 mm hoch  
 Streuwert: 1.85, horizontal: 2.21, vertikal: 1.39

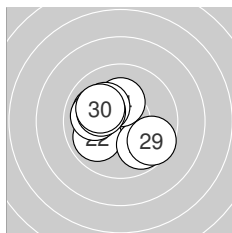

**Serie 3:**

10.2 *	9.9 ↙	9.8 ↘	10.3 *	10.0 ↖
10.2 *	10.0 ↖	10.2 *	9.6 ↘	10.1 ↖

beste Teiler: 174.0 (24.), 191.7 (26.), 196.5 (21.)  
 Trefferlage: 0.89 mm links, 0.06 mm hoch  
 Streuwert: 1.65, horizontal: 1.85, vertikal: 1.41

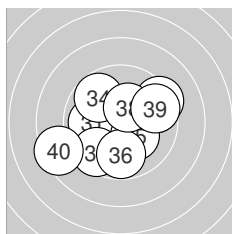

**Serie 4:**

9.9 ←	9.6 →	9.5 ↙	9.8 ↘	10.2 *
9.8 ↓	9.3 →	10.4 *	9.6 →	8.4 ↙

beste Teiler: 149.8 (38.), 181.7 (35.), 256.0 (31.)  
 Trefferlage: 0.05 mm links, 0.15 mm tief  
 Streuwert: 2.59, horizontal: 3.03, vertikal: 2.06



Ergebnis: **411.9** (395)  
 Serien: 103.1 102.0 103.5 103.3  
 Zähler: 35 5 0 0 0 0 0 0 0 0  
 Innenzehner: 28  
 Weitester: 324 (3.), 318 (20.), 315 (18.)  
 beste Teiler: 39.9 (9.), 49.4 (40.), 57.7 (13.)  
 Trefferlage: 0.07 mm rechts, 0.11 mm tief  
 Streuwert: 1.28, horizontal: 1.37, vertikal: 1.19

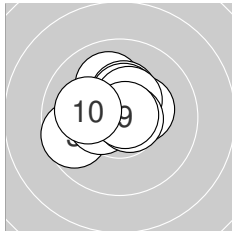
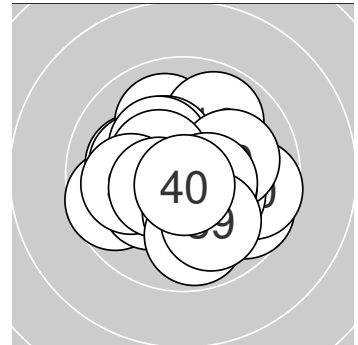

**Serie 1:**  
 10.0 ↗ 10.3 \* 9.7 ↙ 10.4 \* 10.3 \*  
 10.4 \* 10.4 \* 10.7 \* 10.8 \* 10.1 ←  
 beste Teiler: 39.9 (9.), 69.8 (8.), 127.4 (4.)  
 Trefferlage: 0.34 mm links, 0.58 mm hoch  
 Streuwert: 1.21, horizontal: 1.41, vertikal: 0.99

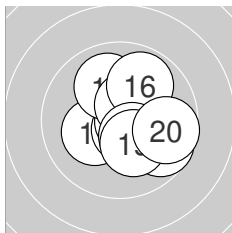

**Serie 2:**  
 10.2 \* 10.7 \* 10.7 \* 10.0 ↗ 10.5 \*  
 9.9 ↗ 10.4 \* 9.7 ↘ 10.2 \* 9.7 →  
 beste Teiler: 57.7 (13.), 71.1 (12.), 116.3 (15.)  
 Trefferlage: 0.80 mm rechts, 0.07 mm tief  
 Streuwert: 1.44, horizontal: 1.43, vertikal: 1.45

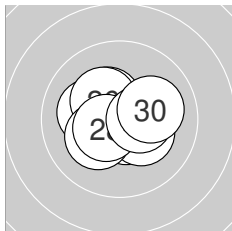

**Serie 3:**  
 10.6 \* 10.3 \* 10.6 \* 10.1 ← 10.4 \*  
 10.3 \* 10.2 \* 10.5 \* 10.4 \* 10.1 →  
 beste Teiler: 80.2 (23.), 90.8 (21.), 107.6 (28.)  
 Trefferlage: 0.16 mm links, 0.00 mm  
 Streuwert: 1.16, horizontal: 1.39, vertikal: 0.87

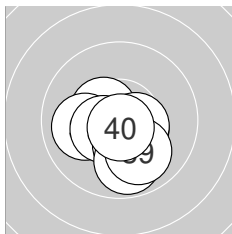

**Serie 4:**  
 10.4 \* 10.5 \* 10.0 ← 10.5 \* 10.5 \*  
 10.3 \* 10.5 \* 9.8 ↓ 10.0 ↘ 10.8 \*  
 beste Teiler: 49.4 (40.), 115.1 (37.), 122.8 (35.)  
 Trefferlage: 0.01 mm rechts, 0.97 mm tief  
 Streuwert: 1.07, horizontal: 1.16, vertikal: 0.98



Ergebnis: **406.7** (389)  
 Serien: 100.7 103.2 102.8 100.0  
 Zähler: 29 11 0 0 0 0 0 0 0 0  
 Innenzehner: 23  
 Weitestе: 490 (35.), 428 (33.), 351 (4.)  
 beste Teiler: 31.0 (17.), 38.8 (20.), 67.2 (39.)  
 Trefferlage: 0.00 mm , 0.31 mm hoch  
 Streuwert: 1.58, horizontal: 1.84, vertikal: 1.27

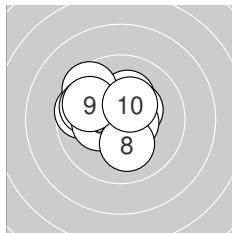
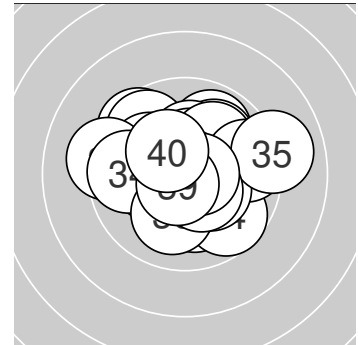

**Serie 1:**  
 10.2 \*                      10.4 \*                      9.7 ←                      9.5 ↘                      9.8 ←  
 10.2 \*                      10.6 \*                      10.1 ↓                      9.8 ↘                      10.4 \*  
 beste Teiler: 91.0 (7.), 142.0 (10.), 144.2 (2.)  
 Trefferlage: 0.87 mm links, 0.64 mm hoch  
 Streuwert: 1.55, horizontal: 1.79, vertikal: 1.25

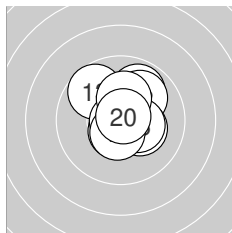

**Serie 2:**  
 9.9 ↗                      10.0 ↗                      9.7 ↘                      10.3 \*                      10.6 \*  
 10.4 \*                      10.8 \*                      10.5 \*                      10.2 \*                      10.8 \*  
 beste Teiler: 31.0 (17.), 38.8 (20.), 97.0 (15.)  
 Trefferlage: 0.33 mm rechts, 0.55 mm hoch  
 Streuwert: 1.27, horizontal: 1.17, vertikal: 1.36

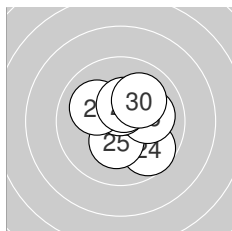

**Serie 3:**  
 10.5 \*                      10.6 \*                      10.5 \*                      9.7 ↘                      10.3 \*  
 10.1 →                      10.5 \*                      10.1 ↖                      10.4 \*                      10.1 ↗  
 beste Teiler: 98.9 (22.), 106.2 (27.), 107.6 (21.)  
 Trefferlage: 0.37 mm rechts, 0.08 mm hoch  
 Streuwert: 1.34, horizontal: 1.28, vertikal: 1.41

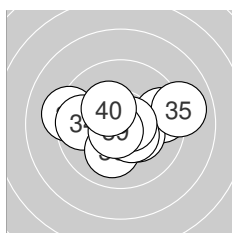

**Serie 4:**  
 9.6 →                      10.3 \*                      9.2 ←                      9.7 ←                      9.0 →  
 10.1 ↓                      10.4 \*                      10.7 \*                      10.7 \*                      10.3 \*  
 beste Teiler: 67.2 (39.), 71.0 (38.), 126.5 (37.)  
 Trefferlage: 0.17 mm rechts, 0.02 mm tief  
 Streuwert: 2.05, horizontal: 2.69, vertikal: 1.08



**Ergebnis:** **411.8** (392)  
**Serien:** 102.7 103.0 103.3 102.8  
**Zähler:** 32 8 0 0 0 0 0 0 0 0  
**Innenzehner:** 25  
**Weiteste:** 452 (28.), 329 (35.), 312 (38.)  
**beste Teiler:** 22.5 (33.), 23.6 (39.), 36.1 (22.)  
**Trefferlage:** 0.13 mm rechts, 0.00 mm  
**Streuwert:** 1.36, horizontal: 1.63, vertikal: 1.02

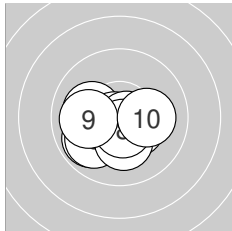
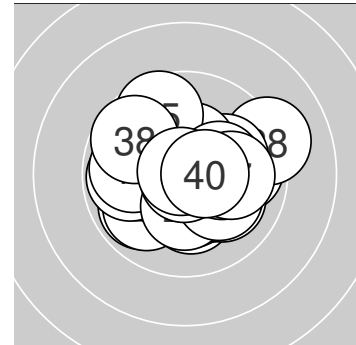

**Serie 1:**  
 9.9 ↙                      10.1 ←                      10.4 \*                      10.8 \*                      10.7 \*  
 9.9 ↙                      10.2 \*                      10.6 \*                      10.0 ←                      10.1 →  
**beste Teiler:** 50.8 (4.), 58.6 (5.), 90.5 (8.)  
**Trefferlage:** 0.47 mm links, 0.69 mm tief  
**Streuwert:** 1.26, horizontal: 1.59, vertikal: 0.79

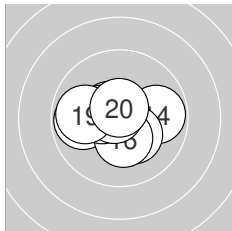

**Serie 2:**  
 10.6 \*                      10.6 \*                      9.8 ←                      9.8 →                      10.3 \*  
 10.3 \*                      10.4 \*                      10.7 \*                      9.9 ←                      10.6 \*  
**beste Teiler:** 51.4 (18.), 80.0 (20.), 90.5 (12.)  
**Trefferlage:** 0.47 mm links, 0.01 mm tief  
**Streuwert:** 1.30, horizontal: 1.67, vertikal: 0.77

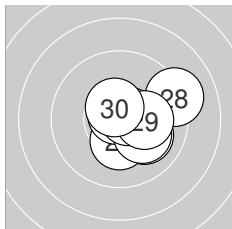

**Serie 3:**  
 10.1 ↘                      10.8 \*                      10.6 \*                      10.3 \*                      10.8 \*  
 10.1 ↘                      10.7 \*                      9.1 →                      10.2 \*                      10.6 \*  
**beste Teiler:** 36.1 (22.), 36.8 (25.), 69.5 (27.)  
**Trefferlage:** 1.06 mm rechts, 0.06 mm tief  
**Streuwert:** 1.23, horizontal: 1.41, vertikal: 1.02

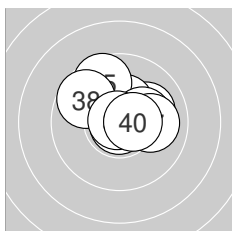

**Serie 4:**  
 10.1 →                      10.5 \*                      10.9 \*                      10.4 \*                      9.6 ↘  
 10.2 \*                      10.0 →                      9.7 ↘                      10.9 \*                      10.5 \*  
**beste Teiler:** 22.5 (33.), 23.6 (39.), 102.0 (40.)  
**Trefferlage:** 0.41 mm rechts, 0.80 mm hoch  
**Streuwert:** 1.30, horizontal: 1.53, vertikal: 1.01



Ergebnis: **396.1** (380)  
 Serien: 99.4 97.8 97.9 101.0  
 Zähler: 22 16 2 0 0 0 0 0 0 0  
 Innenzehner: 14  
 Weitester: 604 (26.), 602 (18.), 440 (17.)  
 beste Teiler: 12.3 (9.), 79.2 (32.), 86.9 (20.)  
 Trefferlage: 0.86 mm rechts, 0.11 mm hoch  
 Streuwert: 2.01, horizontal: 2.25, vertikal: 1.73

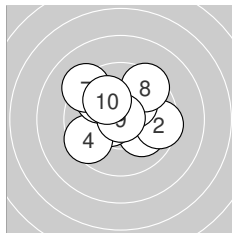
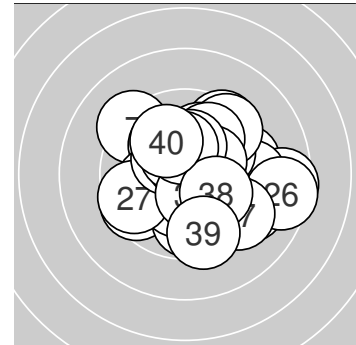

**Serie 1:**

10.0 ↘	9.5 →	10.5 *	9.6 ↙	9.9 ↖
10.2 *	9.2 ↘	9.5 ↗	10.9 *	10.1 ↖

beste Teiler: 12.3 (9.), 103.8 (3.), 184.6 (6.)  
 Trefferlage: 0.13 mm links, 0.72 mm hoch  
 Streuwert: 2.03, horizontal: 2.31, vertikal: 1.69

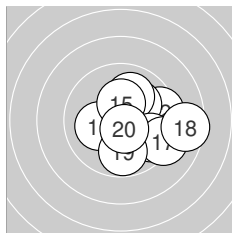

**Serie 2:**

10.1 ↙	9.5 →	10.1 ↗	10.0 ↗	10.3 *
9.7 ↘	9.2 ↘	8.5 →	9.8 ↓	10.6 *

beste Teiler: 86.9 (20.), 157.0 (15.), 206.1 (11.)  
 Trefferlage: 1.74 mm rechts, 0.23 mm tief  
 Streuwert: 2.04, horizontal: 2.34, vertikal: 1.68

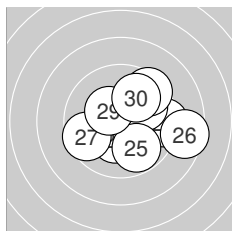

**Serie 3:**

9.3 →	10.6 *	10.3 *	10.0 ↗	9.8 ↘
8.5 →	9.6 ↙	9.5 ↗	10.4 *	9.9 ↗

beste Teiler: 93.0 (22.), 144.4 (29.), 170.2 (23.)  
 Trefferlage: 1.19 mm rechts, 0.00 mm  
 Streuwert: 2.25, horizontal: 2.67, vertikal: 1.73

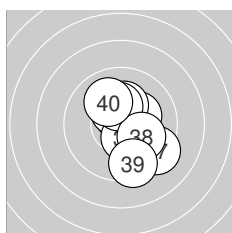

**Serie 4:**

10.3 *	10.6 *	10.4 *	10.2 *	10.4 *
10.3 *	9.3 ↘	10.1 ↘	9.4 ↓	10.0 ↖

beste Teiler: 79.2 (32.), 129.3 (35.), 132.5 (33.)  
 Trefferlage: 0.66 mm rechts, 0.02 mm tief  
 Streuwert: 1.67, horizontal: 1.32, vertikal: 1.95



Ergebnis: **406.0** (386)  
 Serien: 100.9 102.0 101.1 102.0  
 Zähler: 28 11 0 1 0 0 0 0 0 0  
 Innenzehner: 24  
 Weitesten: 768 (6.), 461 (28.), 375 (4.)  
 beste Teiler: 9.0 (39.), 35.8 (17.), 67.2 (38.)  
 Trefferlage: 0.28 mm rechts, 0.11 mm tief  
 Streuwert: 1.73, horizontal: 2.02, vertikal: 1.38

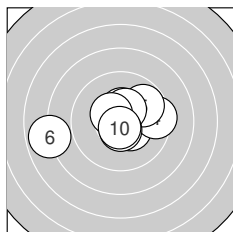
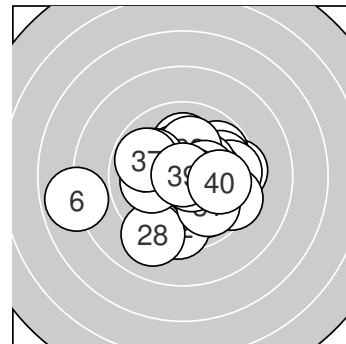

**Serie 1:**  
 10.7 \*                      10.4 \*                      10.4 \*                      9.5 →                      9.8 ↗  
 7.9 ←                      10.4 \*                      10.6 \*                      10.5 \*                      10.7 \*  
 beste Teiler: 68.8 (10.), 73.5 (1.), 94.0 (8.)  
 Trefferlage: 0.14 mm links, 0.17 mm hoch  
 Streuwert: 2.23, horizontal: 2.95, vertikal: 1.13

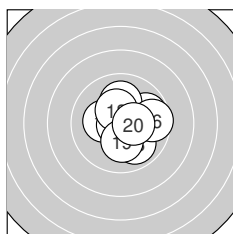

**Serie 2:**  
 10.2 \*                      10.6 \*                      9.9 ↘                      9.8 →                      10.1 ↑  
 9.6 →                      10.8 \*                      10.4 \*                      10.2 \*                      10.4 \*  
 beste Teiler: 35.8 (17.), 93.6 (12.), 137.2 (20.)  
 Trefferlage: 0.67 mm rechts, 0.17 mm hoch  
 Streuwert: 1.44, horizontal: 1.53, vertikal: 1.35

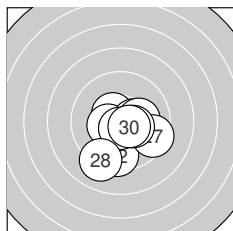

**Serie 3:**  
 10.5 \*                      9.5 ↓                      10.4 \*                      10.4 \*                      10.6 \*  
 10.2 \*                      9.5 ↘                      9.1 ↙                      10.4 \*                      10.5 \*  
 beste Teiler: 77.5 (25.), 106.8 (30.), 113.2 (21.)  
 Trefferlage: 0.42 mm rechts, 1.05 mm tief  
 Streuwert: 1.64, horizontal: 1.67, vertikal: 1.61

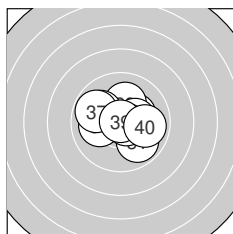

**Serie 4:**  
 9.9 ↘                      10.3 \*                      10.1 ↑                      10.0 ↘                      10.3 \*  
 10.1 ←                      9.8 ↖                      10.7 \*                      10.9 \*                      9.9 →  
 beste Teiler: 9.0 (39.), 67.2 (38.), 155.3 (35.)  
 Trefferlage: 0.16 mm rechts, 0.23 mm hoch  
 Streuwert: 1.52, horizontal: 1.84, vertikal: 1.11



Ergebnis: **409.4** (391)  
 Serien: 100.7 104.5 102.7 101.5  
 Zähler: 32 7 1 0 0 0 0 0 0  
 Innenzehner: 24  
 Weitesten: 512 (34.), 473 (28.), 380 (5.)  
 beste Teiler: 18.9 (12.), 24.0 (21.), 47.8 (30.)  
 Trefferlage: 0.13 mm rechts, 0.46 mm hoch  
 Streuwert: 1.50, horizontal: 1.62, vertikal: 1.38

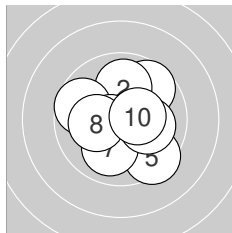
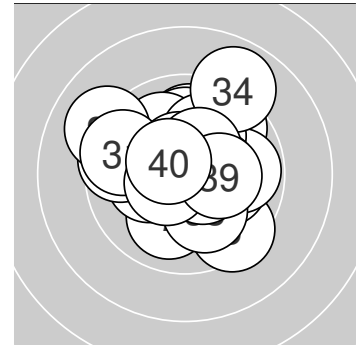

**Serie 1:**  
 9.7 ↗ 10.0 ↑ 10.6 \* 9.7 ↖ 9.4 ↘  
 10.6 \* 10.0 ↘ 10.2 \* 10.1 → 10.4 \*  
 beste Teiler: 83.2 (3.), 84.5 (6.), 135.9 (10.)  
 Trefferlage: 0.25 mm rechts, 0.01 mm tief  
 Streuwert: 1.79, horizontal: 1.84, vertikal: 1.73

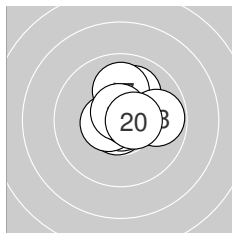

**Serie 2:**  
 10.7 \* 10.9 \* 10.6 \* 10.0 ↗ 10.7 \*  
 10.6 \* 10.0 ↑ 9.8 → 10.7 \* 10.5 \*  
 beste Teiler: 18.9 (12.), 55.4 (11.), 61.7 (15.)  
 Trefferlage: 0.43 mm rechts, 0.53 mm hoch  
 Streuwert: 0.99, horizontal: 1.02, vertikal: 0.96

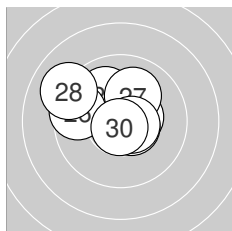

**Serie 3:**  
 10.9 \* 10.5 \* 10.6 \* 10.5 \* 10.0 ↘  
 9.6 ↖ 10.1 ↗ 9.1 ↖ 10.6 \* 10.8 \*  
 beste Teiler: 24.0 (21.), 47.8 (30.), 90.4 (29.)  
 Trefferlage: 0.49 mm links, 0.74 mm hoch  
 Streuwert: 1.53, horizontal: 1.86, vertikal: 1.10

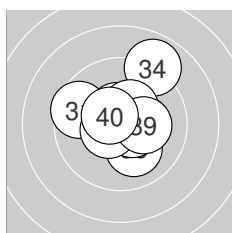

**Serie 4:**  
 9.6 ↖ 10.5 \* 10.1 ↘ 8.9 ↗ 10.5 \*  
 10.3 \* 10.4 \* 10.5 \* 10.2 \* 10.5 \*  
 beste Teiler: 101.7 (35.), 105.1 (38.), 107.5 (32.)  
 Trefferlage: 0.33 mm rechts, 0.57 mm hoch  
 Streuwert: 1.68, horizontal: 1.71, vertikal: 1.66





Ergebnis: **406.9** (387)  
 Serien: 101.8 102.9 99.9 102.3  
 Zähler: 27 13 0 0 0 0 0 0 0 0  
 Innenzehner: 21  
 Weitesten: 445 (21.), 357 (28.), 345 (23.)  
 beste Teiler: 22.8 (9.), 37.2 (37.), 43.9 (30.)  
 Trefferlage: 0.52 mm rechts, 0.15 mm tief  
 Streuwert: 1.52, horizontal: 1.65, vertikal: 1.39

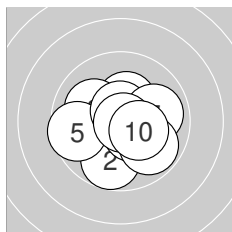
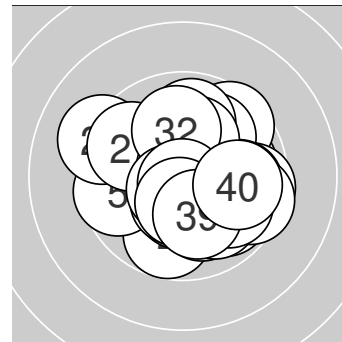

**Serie 1:**  
 10.3 \*                      9.8 ↓                      10.1 ↖                      10.5 \*                      9.6 ←  
 10.6 \*                      9.9 →                      9.8 ↘                      10.9 \*                      10.3 \*  
 beste Teiler: 22.8 (9.), 79.1 (6.), 120.3 (4.)  
 Trefferlage: 0.14 mm rechts, 0.32 mm tief  
 Streuwert: 1.58, horizontal: 1.78, vertikal: 1.35

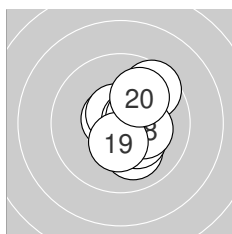

**Serie 2:**  
 10.1 ↓                      10.3 \*                      9.6 ↗                      10.6 \*                      10.6 \*  
 10.6 \*                      10.5 \*                      10.2 \*                      10.4 \*                      10.0 ↗  
 beste Teiler: 80.6 (14.), 81.8 (15.), 82.7 (16.)  
 Trefferlage: 0.83 mm rechts, 0.11 mm hoch  
 Streuwert: 1.23, horizontal: 0.98, vertikal: 1.44

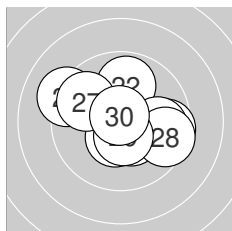

**Serie 3:**  
 9.2 ↖                      9.9 ↑                      9.6 →                      10.4 \*                      10.4 \*  
 9.8 →                      9.8 ↖                      9.5 →                      10.5 \*                      10.8 \*  
 beste Teiler: 43.9 (30.), 112.9 (29.), 128.0 (25.)  
 Trefferlage: 0.38 mm rechts, 0.08 mm hoch  
 Streuwert: 2.00, horizontal: 2.44, vertikal: 1.44

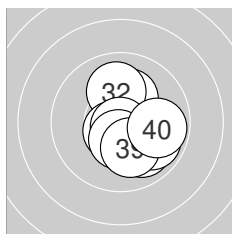

**Serie 4:**  
 10.2 \*                      10.0 ↑                      10.6 \*                      10.0 ↓                      9.9 ↘  
 10.5 \*                      10.8 \*                      10.4 \*                      10.1 ↓                      9.8 →  
 beste Teiler: 37.2 (37.), 89.1 (33.), 124.0 (36.)  
 Trefferlage: 0.75 mm rechts, 0.49 mm tief  
 Streuwert: 1.30, horizontal: 1.14, vertikal: 1.45

