

Ergebnis: **539** 171 Serien: 84 87
 187 93 94
 181 91 90
 Zähler: 18 29 10 2 0 0 Innenzehner: 7

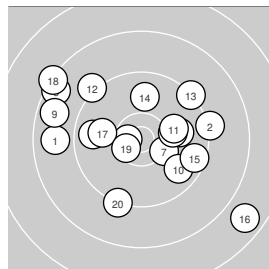
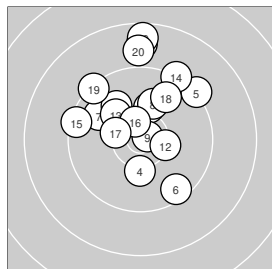
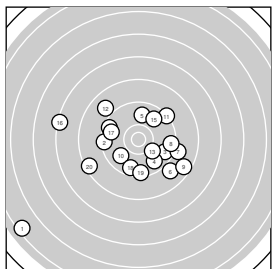

kniend Wertung

liegend Wertung

stehend Wertung

Serie: 1 4.5 ↙ 9.4 ← 9.7 → 9.8 ↘ 9.9 ↑ 9.0 ↘ 9.1 → 9.5 → 8.6 → 9.9 ↙
 Serie: 2 9.3 ↗ 8.9 ↘ 10.2 ↘ 9.6 ↖ 9.8 ↗ 7.4 ← 9.7 ← 9.7 ↓ 9.5 ↓ 8.5 ↖

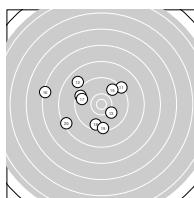
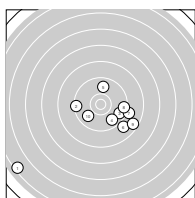

Serie: 1 10.2 ↘ 8.8 ↑ 10.2 ↑ 10.2 ↓ 9.3 ↗ 9.6 ↘ 9.9 ↖ 10.1 ↑ 10.8 * 8.6 ↑
 Serie: 2 10.0 ↘ 10.4 * 10.1 ↘ 9.3 ↑ 9.4 ← 10.5 * 10.4 * 9.8 ↑ 9.4 ↘ 8.9 ↑

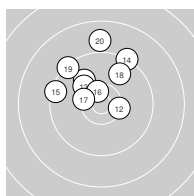
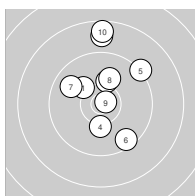

Serie: 1 8.8 ← 9.2 → 9.8 ← 10.6 * 8.5 ↖ 10.0 → 10.3 * 10.2 → 8.7 ↖ 9.8 ↘
 Serie: 2 10.1 → 9.2 ↘ 9.3 ↗ 9.9 ↑ 9.6 → 7.8 ↘ 10.0 ← 8.3 ↖ 10.5 * 9.3 ↓

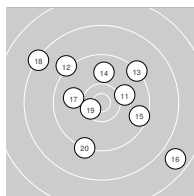
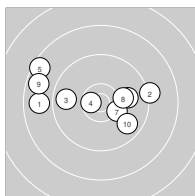

Ergebnis: **502** 171 Serien: 84 87
 179 88 91
 152 85 67
 Zähler: 10 24 14 5 4 3 Innenzehner: 6

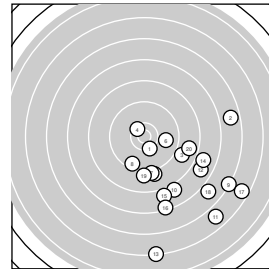
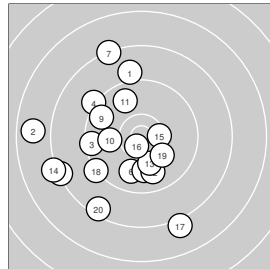
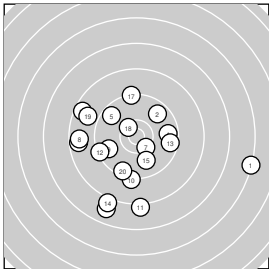

kniend Wertung

liegend Wertung

stehend Wertung

Serie: 1 6.3 → 9.7 ↗ 8.7 ← 9.7 → 9.7 ↘ 7.9 ↓ 10.4 * 8.7 ← 9.8 ← 9.3 ↓
 Serie: 2 8.2 ↓ 9.4 ← 9.6 → 8.1 ↓ 9.9 ↓ 8.6 ↖ 9.3 ↑ 10.5 * 8.9 ↖ 9.5 ↓

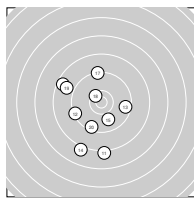
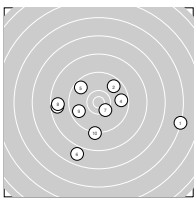

Serie: 1 9.0 ↑ 7.8 ← 9.5 ← 9.2 ↖ 8.4 ← 9.9 ↓ 8.3 ↑ 10.0 ↓ 9.7 ↖ 10.0 ←
 Serie: 2 9.8 ↗ 9.9 ↓ 10.1 ↓ 8.2 ← 10.4 * 10.6 * 8.1 ↓ 9.3 ← 10.1 ↘ 8.5 ↓

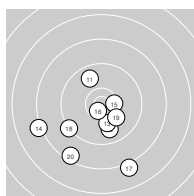
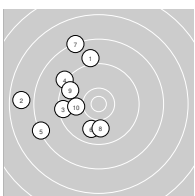

Serie: 1 10.3 * 6.7 → 9.0 → 10.5 * 9.1 ↓ 9.9 → 9.2 ↓ 9.5 ↓ 6.3 → 8.0 ↓
 Serie: 2 5.8 ↘ 7.8 → 5.3 ↓ 7.9 → 8.0 ↓ 7.4 ↓ 5.6 → 6.9 → 9.1 ↓ 8.7 →

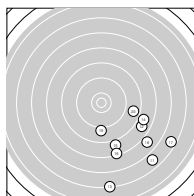
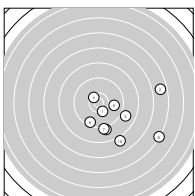

Ergebnis: **552** 188 Serien: 95 93
 196 100 96
 168 82 86
 Zähler: 31 16 8 4 1 0 Innenzehner: 17

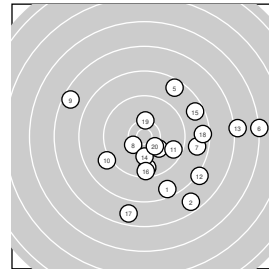
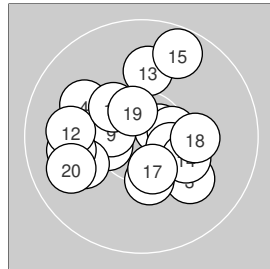
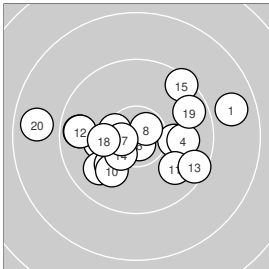

kniend Wertung

liegend Wertung

stehend Wertung

Serie: 1 8.8 → 10.2 ← 10.1 → 9.9 → 9.7 ← 10.8 * 9.9 ↙ 10.7 * 10.1 ↘ 10.1 ↘
 Serie: 2 9.9 ↘ 9.7 ← 9.6 → 10.5 * 9.5 ↗ 10.5 * 10.6 * 10.2 ← 9.7 → 8.8 ←

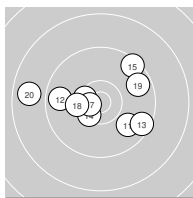
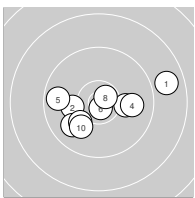

Serie: 1 10.1 ← 10.5 * 10.0 ↘ 10.0 ↘ 10.7 * 10.5 * 10.3 * 10.5 * 10.5 * 10.1 ←
 Serie: 2 9.9 ← 9.9 ← 10.0 ↑ 10.2 ↘ 9.7 ↑ 10.4 * 10.5 * 10.2 → 10.6 * 9.9 ←

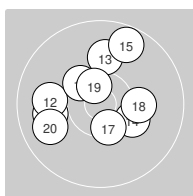
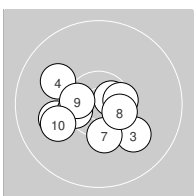

Serie: 1 8.6 ↘ 7.7 ↘ 9.7 ↓ 10.2 ↘ 8.6 ↗ 6.3 → 8.8 → 10.4 * 7.6 ↘ 9.2 ↘
 Serie: 2 9.7 → 8.2 ↘ 7.2 → 10.1 ↓ 8.7 → 9.5 ↓ 7.8 ↓ 8.6 → 10.3 * 10.4 *

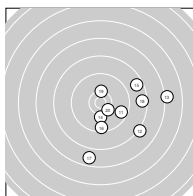
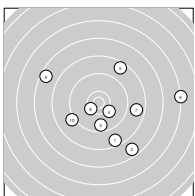

Ergebnis: **552** 190 Serien: 95 95
 194 96 98
 168 87 81
 Zähler: 26 22 10 2 0 0 Innenzehner: 11

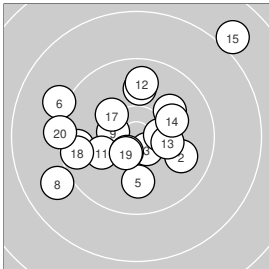

kniend Wertung

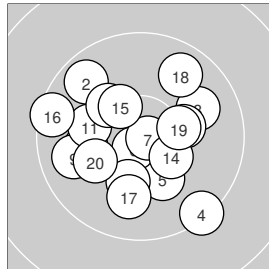

liegend Wertung

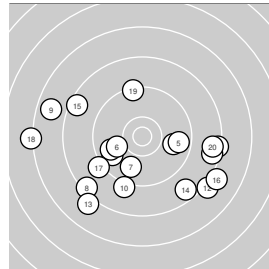

stehend Wertung

Serie: 1 10.1 ↗ 9.9 ↘ 10.6 * 9.7 ← 10.0 ↓ 9.2 ↖ 9.9 ↑ 9.0 ← 10.4 * 10.5 *
 Serie: 2 10.1 ↖ 9.8 ↑ 10.3 → 10.1 ↗ 8.0 ↗ 10.6 * 10.3 ↘ 9.6 ← 10.5 * 9.3 ←

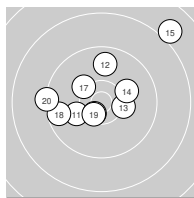
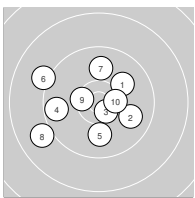

Serie: 1 10.1 ← 9.7 ↘ 10.4 * 9.4 ↘ 10.2 ↘ 10.7 * 10.8 * 9.9 ↗ 9.8 ← 10.2 ↓
 Serie: 2 10.1 ← 10.2 ↘ 10.2 → 10.4 * 10.4 * 9.5 ← 10.0 ↓ 9.8 ↗ 10.3 * 10.1 ←

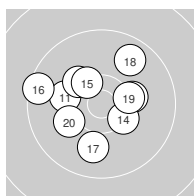
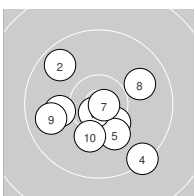

Serie: 1 9.9 → 9.8 ← 9.8 ← 8.4 → 9.7 → 10.0 ← 9.9 ↓ 8.4 ← 7.8 ↖ 9.2 ↓
 Serie: 2 8.6 → 8.2 ↘ 8.1 ↖ 8.7 ↘ 8.5 ↖ 8.1 ↘ 9.2 ↖ 7.2 ← 9.4 ↑ 8.6 →

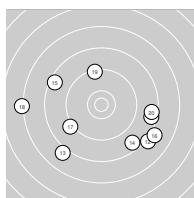
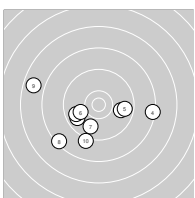

Ergebnis: **542** 182 Serien: 92 90
 194 97 97
 166 87 79
 Zähler: 26 22 6 3 1 1 Innenzehner: 14

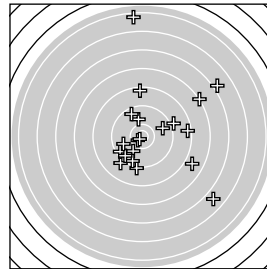
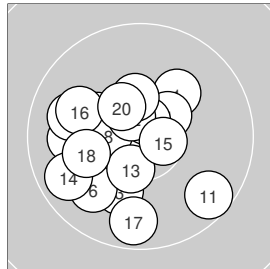
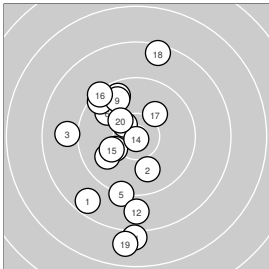

kniend Wertung

liegend Wertung

stehend Wertung

Serie: 1 8.7 ↘ 10.0 ↓ 9.0 ← 10.3 ↙ 9.3 ↓ 9.9 ↘ 9.5 ↘ 9.7 ↘ 9.8 ↘ 10.0 ↙
 Serie: 2 8.1 ↓ 8.8 ↓ 10.5 * 10.9 * 10.2 ↙ 9.4 ↘ 10.1 ↗ 8.5 ↑ 7.9 ↓ 10.3 *

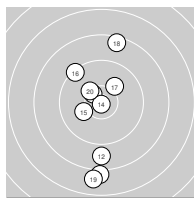
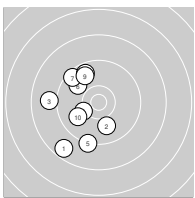

Serie: 1 10.1 ↗ 10.3 ↘ 10.1 ↓ 10.4 * 9.9 ← 9.9 ↙ 10.8 * 10.5 * 10.7 * 9.9 ←
 Serie: 2 9.6 ↘ 10.6 * 10.5 * 9.7 ↙ 10.6 * 10.0 ↘ 9.7 ↓ 10.1 ← 10.4 * 10.4 *

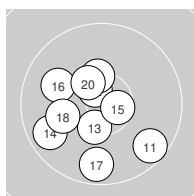
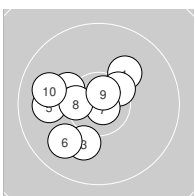

Serie: 1 9.1 ↘ 10.6 * 9.2 ↓ 10.0 ↙ 10.0 ↑ 5.9 ↘ 9.1 → 9.5 ↙ 9.5 ↓ 7.9 ↘
 Serie: 2 8.5 ↑ 8.5 → 6.1 ↗ 9.6 ↘ 10.8 * 4.5 ↑ 9.8 → 9.6 ↙ 9.9 ← 7.3 ↗

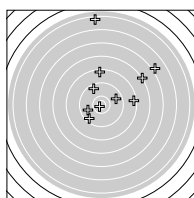
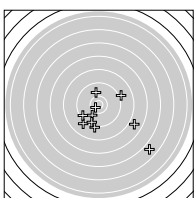

Ergebnis: **553** 185 Serien: 91 94
 191 96 95
 177 90 87
 Zähler: 26 23 9 2 0 0 Innenzehner: 12

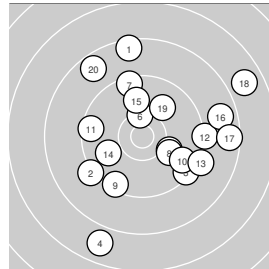
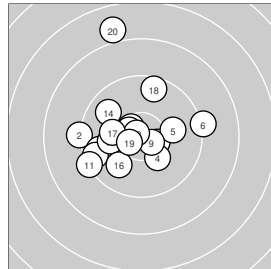
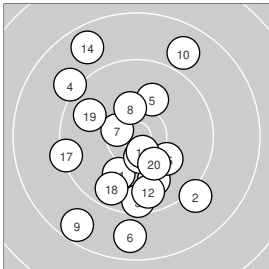

kniend Wertung

liegend Wertung

stehend Wertung

Serie: 1 10.0 ↘ 9.2 ↘ 9.6 ↓ 9.1 ↖ 10.1 ↑ 8.8 ↓ 10.5 * 10.3 * 8.7 ↙ 8.9 ↗
 Serie: 2 10.1 ↘ 9.7 ↓ 10.5 * 8.8 ↖ 10.1 ↘ 10.6 * 9.4 ← 9.7 ↘ 9.8 ↖ 10.3 ↘

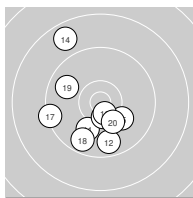
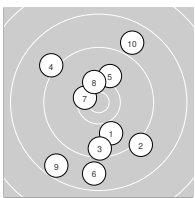

Serie: 1 10.5 * 9.3 ← 9.8 ← 10.2 ↘ 10.1 → 9.2 → 10.5 * 9.6 ← 10.6 * 10.6 *
 Serie: 2 9.3 ← 10.6 * 10.8 * 9.8 ↖ 10.1 ← 10.0 ↘ 10.2 ← 9.6 ↑ 10.6 * 8.0 ↑

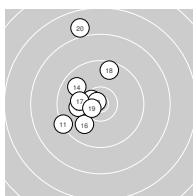
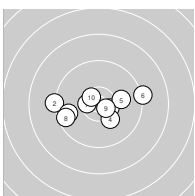

Serie: 1 8.5 ↑ 9.2 ↙ 9.4 ↘ 7.8 ↓ 10.1 ↘ 10.4 * 9.5 ↑ 10.1 ↘ 9.5 ↙ 9.7 ↘
 Serie: 2 9.5 ← 9.3 → 9.2 → 9.9 ← 10.0 ↑ 8.8 → 8.6 → 7.8 → 10.0 ↑ 8.7 ↖

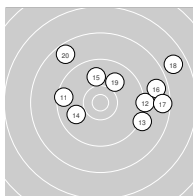
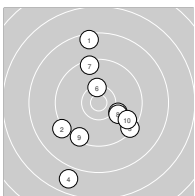

Ergebnis: **533** 180 Serien: 91 89
 188 95 93
 165 82 83
 Zähler: 17 26 14 2 0 0 Innenzehner: 9

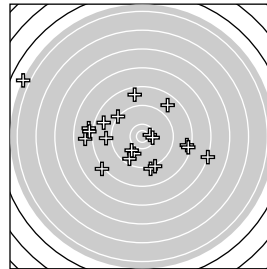
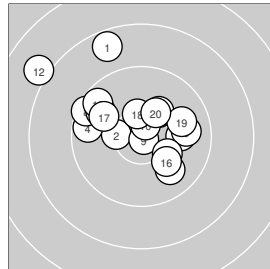
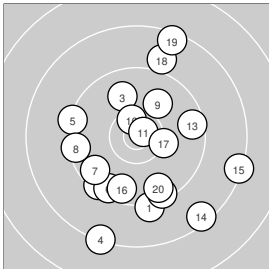

kneid Wertung

liegend Wertung

stehend Wertung

Serie: 1 9.2 ↓ 9.5 ↗ 9.9 ↖ 8.3 ↓ 9.4 ← 9.5 ↓ 9.7 ↙ 9.5 ← 10.0 ↗ 10.5 *
 Serie: 2 10.8 * 9.4 ↓ 9.6 → 8.5 ↓ 8.4 → 9.7 ↓ 10.3 → 9.0 ↑ 8.5 ↑ 9.6 ↓

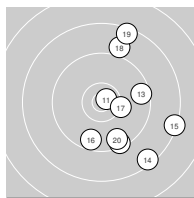
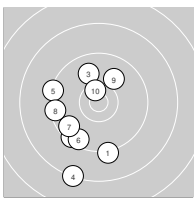

Serie: 1 8.7 ↖ 10.4 * 10.0 → 9.7 ← 10.3 ↗ 9.9 → 10.2 ↗ 9.5 ↖ 10.9 * 10.7 *
 Serie: 2 9.8 ↖ 8.1 ↖ 9.7 ↖ 10.2 ↘ 9.9 ↘ 10.1 ↘ 9.9 ↖ 10.4 * 9.9 → 10.3 *

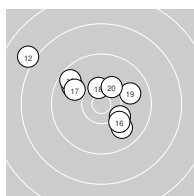
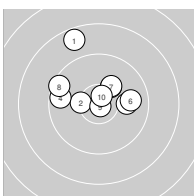

Serie: 1 9.2 ↓ 9.2 ↓ 8.1 ← 9.3 ↖ 8.8 ← 7.9 ← 9.0 ← 8.5 → 8.7 ↑ 7.3 →
 Serie: 2 10.5 * 8.4 → 9.9 ↓ 8.2 ↗ 9.6 ↓ 10.0 ↓ 10.4 * 8.1 ← 8.8 ↗ 3.9 ↖

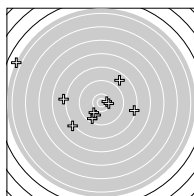
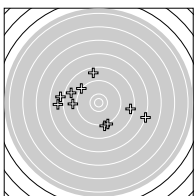

Ergebnis: **561** 186 Serien: 94 92
 193 96 97
 182 91 91
 Zähler: 29 23 8 0 0 0 Innenzehner: 17

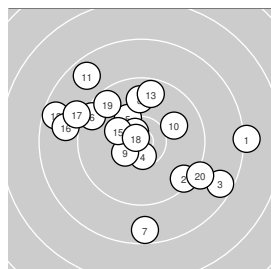
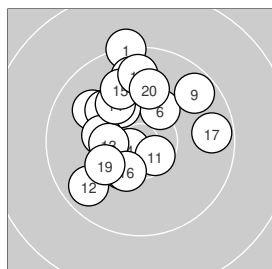
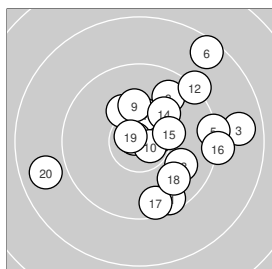

kniend Wertung

liegend Wertung

stehend Wertung

Serie: 1 10.2 ↘ 10.5 * 8.8 → 10.4 * 9.4 → 8.6 ↗ 10.8 * 9.8 ↗ 10.2 ↑ 10.7 *
 Serie: 2 9.6 ↘ 9.3 ↗ 9.9 ↘ 10.2 ↗ 10.3 * 9.3 → 9.6 ↓ 9.9 ↘ 10.7 * 8.9 ←

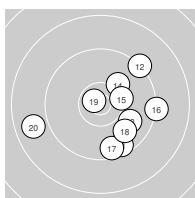
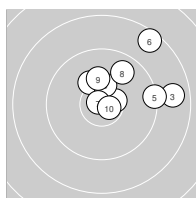

Serie: 1 9.3 ↑ 9.9 ↘ 10.4 * 10.7 * 9.8 ↑ 10.3 * 10.1 ↘ 10.3 ↘ 9.7 ↗ 10.3 ←
 Serie: 2 10.6 * 9.8 ↗ 10.4 * 10.2 ↘ 10.0 ↘ 10.4 * 9.7 → 9.8 ↑ 10.2 ↗ 10.0 ↑

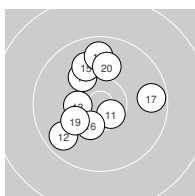
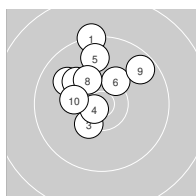

Serie: 1 8.2 → 9.5 ↘ 8.6 ↘ 10.6 * 10.2 ↘ 9.5 ↘ 8.7 ↓ 9.9 ↑ 10.4 * 10.0 →
 Serie: 2 8.7 ↘ 8.6 ← 9.7 ↑ 10.7 * 10.3 * 9.0 ← 9.1 ← 10.8 * 9.6 ↘ 9.2 ↘

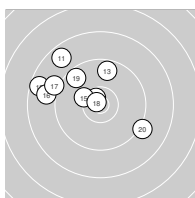
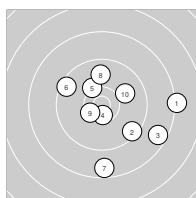

Ergebnis: **563** 190 Serien: 94 96
 191 94 97
 182 93 89
 Zähler: 30 24 5 1 0 0 Innenzehner: 14

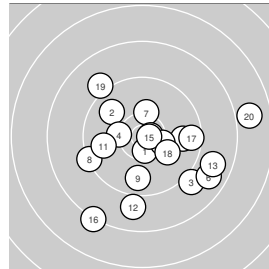
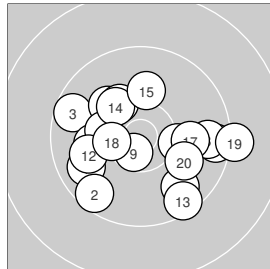
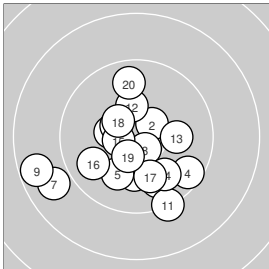

kniend Wertung

liegend Wertung

stehend Wertung

Serie: 1 10.1 ↓ 10.5 * 9.9 ↘ 9.6 ↘ 10.1 ↙ 10.4 * 8.9 ↙ 10.6 * 8.7 ↙ 10.5 *
 Serie: 2 9.3 ↘ 10.3 ↑ 10.1 → 9.9 ↘ 10.6 * 9.9 ↙ 10.0 ↓ 10.4 * 10.5 * 9.8 ↑

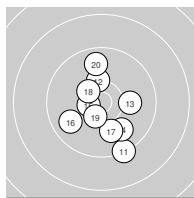
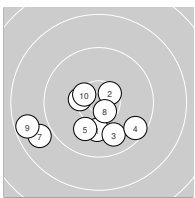

Serie: 1 9.8 ↙ 9.6 ↙ 9.6 ↙ 10.1 ← 10.1 ↘ 10.2 ↘ 9.6 → 9.7 → 10.6 * 9.8 ↘
 Serie: 2 10.3 ← 9.9 ↙ 9.5 ↘ 10.2 ↘ 10.1 ↑ 10.3 → 10.0 → 10.4 * 9.2 → 10.0 ↘

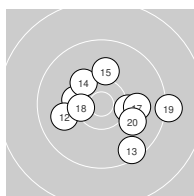
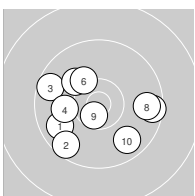

Serie: 1 10.5 * 9.9 ↘ 9.1 ↘ 10.3 * 9.8 → 8.8 ↘ 10.3 ↑ 9.3 ↙ 9.8 ↓ 10.7 *
 Serie: 2 9.8 ↙ 9.0 ↓ 8.8 → 10.4 * 10.8 * 8.3 ↙ 9.6 → 10.1 ↘ 9.1 ↘ 7.9 →

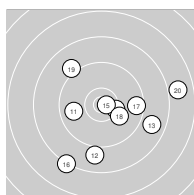
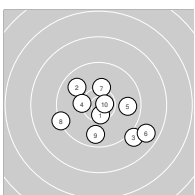

Ergebnis: **543** 186 Serien: 91 95
 196 99 97
 161 82 79
 Zähler: 28 18 8 5 0 0 Innenzehner: 16

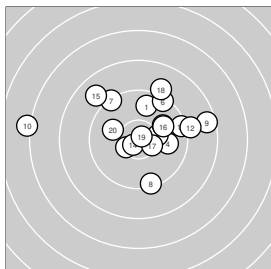

kniend Wertung

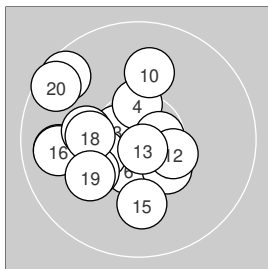

liegend Wertung

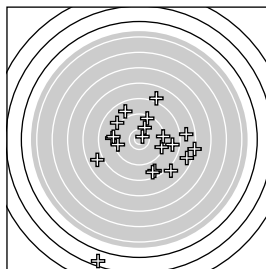

stehend Wertung

Serie: 1 9.8 ↑ 10.1 → 10.5 * 10.0 → 10.3 * 9.4 ↑ 9.4 ↘ 9.4 ↓ 8.6 → 7.2 ←
 Serie: 2 9.5 → 9.2 → 10.0 ↗ 10.7 * 8.9 ↘ 10.0 → 10.5 * 9.1 ↑ 10.8 * 10.0 ↖

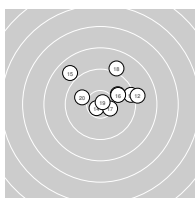
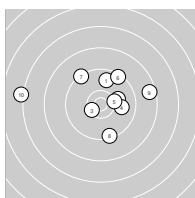

Serie: 1 10.8 * 10.9 * 10.6 * 10.5 * 10.7 * 10.5 * 10.4 * 9.6 ↘ 10.4 * 10.0 ↑
 Serie: 2 10.2 ↙ 10.4 * 10.8 * 9.8 ← 10.0 ↓ 9.8 ← 10.2 ← 10.3 ← 10.1 ↙ 9.6 ↖

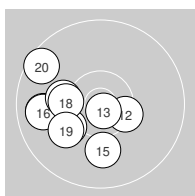
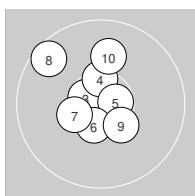

Serie: 1 7.3 → 8.7 ↓ 7.9 ← 8.9 ↘ 9.5 ↑ 8.8 → 9.2 ← 10.1 ↑ 9.5 ← 7.9 →
 Serie: 2 8.7 ↓ 9.4 → 8.1 ↓ 2.6 ↓ 9.2 ↘ 8.1 ↑ 7.6 → 9.4 → 9.3 ← 10.7 *

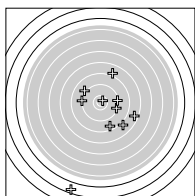
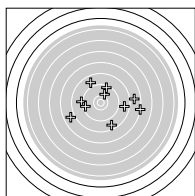

Ergebnis: **542** 180 Serien: 93 87
 192 95 97
 170 82 88
 Zähler: 20 28 7 4 1 0 Innenzehner: 5

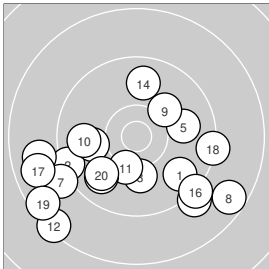

kniend Wertung

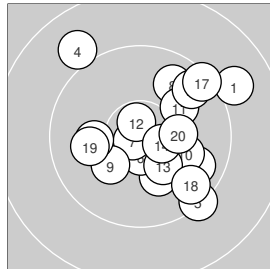

liegend Wertung

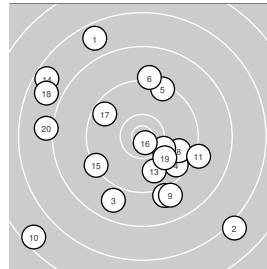

stehend Wertung

Serie: 1 9.8 ↘ 9.4 ↙ 10.1 ↓ 9.2 ↘ 10.0 → 10.0 ← 9.1 ↙ 8.7 ↘ 10.1 ↗ 9.9 ←
 Serie: 2 10.3 ↓ 8.4 ↙ 9.8 ↗ 9.8 ↑ 8.9 ← 9.3 ↘ 8.8 ← 9.3 → 8.6 ↙ 9.9 ↗

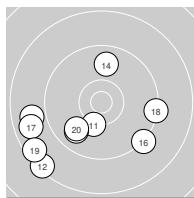
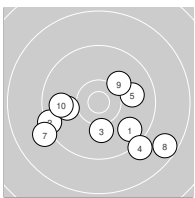

Serie: 1 9.0 ↗ 10.1 ↓ 9.8 ↘ 9.0 ↘ 9.4 ↘ 10.6 * 10.8 * 9.8 ↗ 10.2 ↙ 10.1 →
 Serie: 2 10.1 ↗ 10.7 * 10.3 ↘ 10.5 * 10.1 ← 9.7 ↗ 9.5 ↗ 9.7 ↘ 10.0 ← 10.3 →

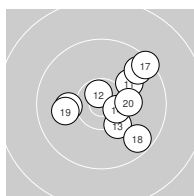
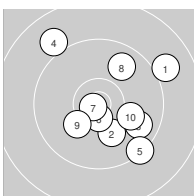

Serie: 1 7.7 ↖ 7.1 ↘ 8.9 ↙ 9.6 ↘ 9.4 ↑ 9.2 ↑ 9.1 ↓ 9.8 → 9.0 ↓ 6.6 ↙
 Serie: 2 9.2 → 10.2 → 9.9 ↓ 7.7 ↖ 9.3 ↙ 10.7 * 9.7 ↖ 7.8 ↖ 10.0 ↘ 8.1 ←

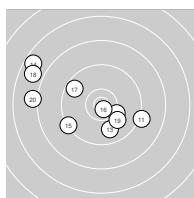
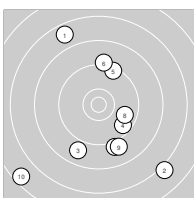

KK 3x20 – Wertung –

Herren III

StartNr: 424

StandNr: 6

19. Juni 2022 11:13

DSC Wanne-Eickel Schießsport e.V / DSC Wanne-Eickel Schießsport e.V. I

Ergebnis: **532** 176 Serien: 85 91
 194 99 95
 162 80 82

Zähler: 21 20 13 3 2 1 Innenzehner: 13

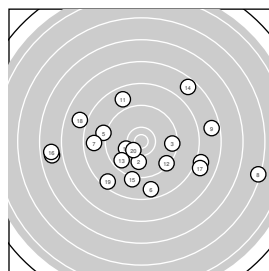
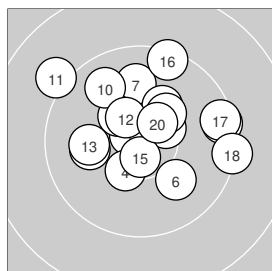
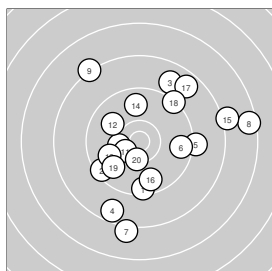

kniend Wertung

liegend Wertung

stehend Wertung

Serie: 1 9.5 ↓ 9.5 ↙ 8.9 ↗ 8.7 ↓ 9.2 → 9.7 → 8.2 ↓ 7.5 → 8.3 ↘ 10.3 *
 Serie: 2 10.4 * 10.0 ↘ 9.9 ↙ 9.8 ↑ 8.1 → 9.7 ↓ 8.7 ↗ 9.3 ↗ 9.8 ↙ 10.4 *

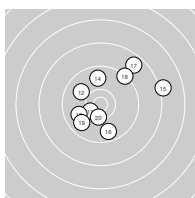
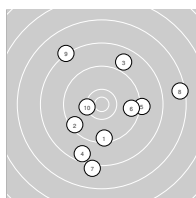

Serie: 1 10.7 * 10.3 * 10.5 * 10.4 * 10.1 ← 10.0 ↘ 10.0 ↑ 10.2 ↗ 10.4 * 9.8 ↘
 Serie: 2 9.1 ↘ 10.5 * 10.1 ← 9.5 → 10.7 * 9.5 ↑ 9.5 → 9.3 → 10.3 * 10.5 *

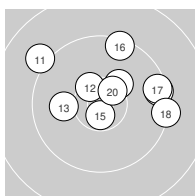
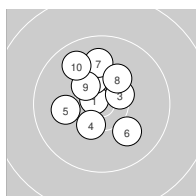

Serie: 1 8.1 → 10.0 ↓ 9.5 → 6.8 ← 9.2 ← 8.7 ↓ 8.8 ← 5.4 → 7.7 → 10.2 ↙
 Serie: 2 8.8 ↘ 9.4 ↘ 9.7 ↙ 7.7 ↗ 9.2 ↓ 6.8 ← 8.0 → 8.0 ↖ 8.6 ↙ 10.4 *

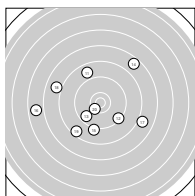
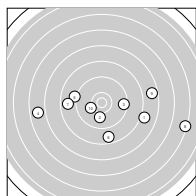

KK 3x20 – Wertung –

Herren IV

StartNr: 426

StandNr: 10

19. Juni 2022 11:26

Linne, DSC Wanne-Eickel Schießsport e.V. / DSC Wanne-Eickel Schießsport e.V. I

Ergebnis: **541** 183 Serien: 90 93
 194 96 98
 164 81 83

Zähler: 25 17 14 2 2 0 Innenzehner: 13

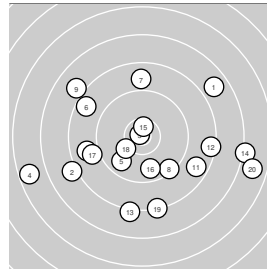
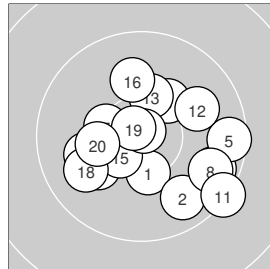
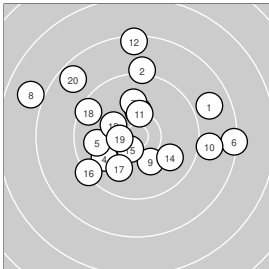

kniend Wertung

liegend Wertung

stehend Wertung

Serie: 1 8.9 → 9.2 ↑ 10.3 ↑ 9.9 ↙ 9.9 ← 8.4 → 10.0 ↑ 8.0 ↘ 10.2 ↓ 9.0 →
 Serie: 2 10.3 * 8.4 ↑ 10.3 ↖ 9.9 ↘ 10.6 * 9.4 ↙ 10.0 ↓ 9.5 ↘ 10.5 * 8.7 ↘

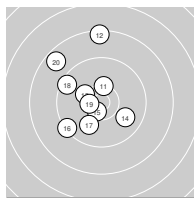
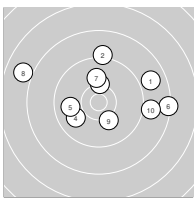

Serie: 1 10.4 * 9.8 ↘ 10.3 ↗ 9.7 ↘ 9.6 → 10.5 * 10.4 * 9.7 ↘ 10.8 * 10.0 ←
 Serie: 2 9.4 ↘ 10.0 → 10.3 * 10.1 ↙ 10.5 * 10.0 ↑ 10.9 * 9.9 ↙ 10.8 * 10.2 ←

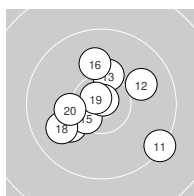
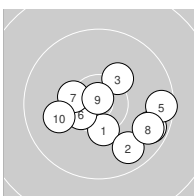

Serie: 1 7.8 ↗ 8.1 ← 10.8 * 6.7 ← 9.8 ↙ 8.7 ↘ 8.9 ↑ 9.4 ↓ 8.0 ↘ 8.9 ←
 Serie: 2 8.7 ↘ 8.5 → 8.2 ↓ 7.2 → 10.6 * 9.8 ↓ 9.0 ← 10.2 ↙ 8.3 ↓ 6.8 →

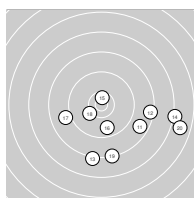
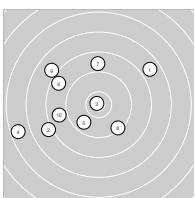

Ergebnis: **557** 188 Serien: 93 95
 196 96 100
 173 85 88
 Zähler: 30 19 9 2 0 0 Innenzehner: 19

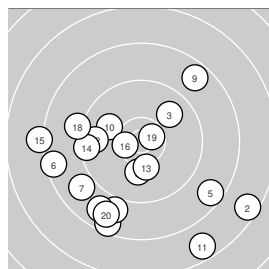
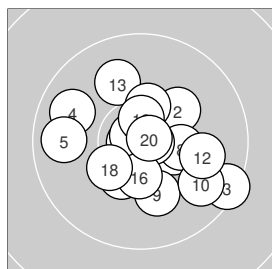
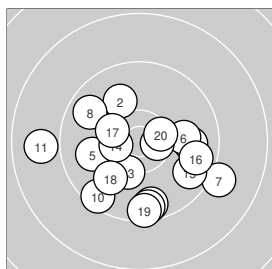

kniend Wertung

liegend Wertung

stehend Wertung

Serie: 1 9.6 ↓ 10.0 ↖ 9.9 → 10.3 * 9.9 ← 10.0 → 9.1 ↘ 9.8 ↙ 9.6 ↓ 9.5 ↗
 Serie: 2 8.9 ← 10.6 * 10.3 ↘ 10.5 * 9.7 ↘ 9.7 → 10.3 * 10.0 ↗ 9.5 ↓ 10.5 *

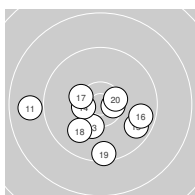
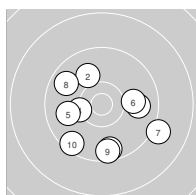

Serie: 1 10.6 * 10.2 ↗ 9.5 ↘ 9.8 ↙ 9.8 ← 10.4 * 10.8 * 10.3 * 10.1 ↓ 9.8 ↘
 Serie: 2 10.3 * 10.0 → 10.0 ↖ 10.8 * 10.8 * 10.4 * 10.4 * 10.3 * 10.6 * 10.8 *

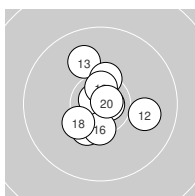
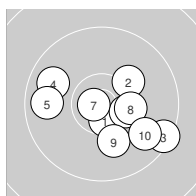

Serie: 1 8.6 ↘ 7.6 ↘ 9.9 ↗ 9.0 ↓ 8.6 ↘ 8.5 ← 8.9 ↗ 10.1 ↓ 8.7 ↗ 10.0 ↖
 Serie: 2 7.7 ↘ 9.7 ← 10.2 ↓ 9.5 ← 8.2 ← 10.5 * 8.8 ↘ 9.2 ← 10.6 * 8.8 ↘

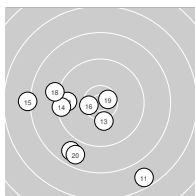
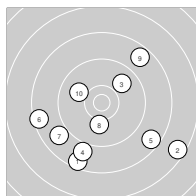

Ergebnis: **535** 180 Serien: 92 88
 189 95 94
 166 80 86

Zähler: 21 22 12 3 1 0 Innenzehner: 12

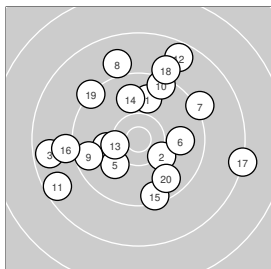

kniend Wertung

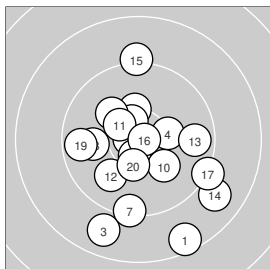

liegend Wertung

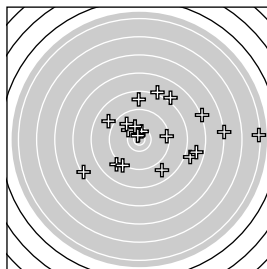

stehend Wertung

Serie: 1 9.9 ↑ 10.2 ↘ 8.7 ← 10.1 ← 10.1 ↙ 9.9 → 9.2 ↗ 9.0 ↑ 9.6 ← 9.5 ↑
 Serie: 2 8.6 ↙ 8.7 ↑ 10.3 * 9.9 ↑ 9.5 ↓ 9.1 ← 8.3 → 9.1 ↑ 9.3 ↘ 9.8 ↘

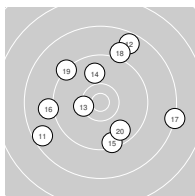
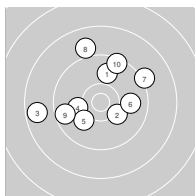

Serie: 1 8.6 ↘ 10.8 * 8.9 ↓ 10.3 * 10.3 * 10.6 * 9.4 ↓ 10.5 * 10.1 ↘ 10.2 ↘
 Serie: 2 10.4 * 10.0 ↙ 9.7 → 8.9 ↘ 9.2 ↑ 10.8 * 9.3 ↘ 10.0 ← 9.7 ← 10.4 *

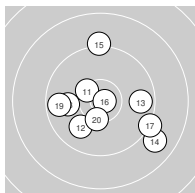
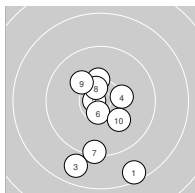

Serie: 1 6.3 → 8.2 ↑ 9.0 ↘ 9.4 → 7.2 → 4.4 → 8.0 → 10.5 * 10.2 ↘ 9.1 ↙
 Serie: 2 10.2 ↑ 10.7 * 7.7 → 8.1 ↑ 9.8 ↘ 10.7 * 9.3 ↙ 7.4 ↙ 8.9 ↘ 8.7 ↑

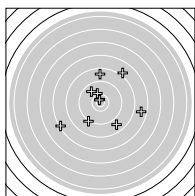
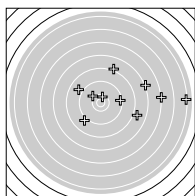

Ergebnis: **545** 179 Serien: 89 90
 195 98 97
 171 85 86
 Zähler: 23 26 6 4 0 1 Innenzehner: 14

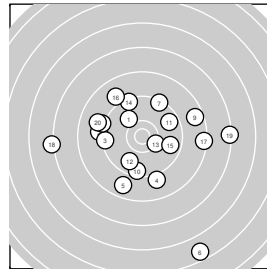
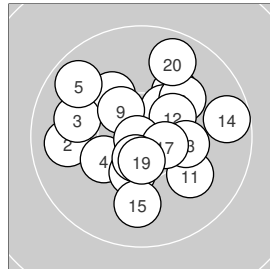
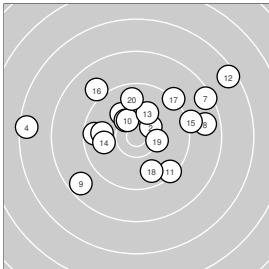

kniend Wertung

liegend Wertung

stehend Wertung

Serie: 1 9.6 ← 10.4 * 9.9 ← 7.5 ← 10.1 ↖ 10.3 * 8.5 ↗ 8.8 → 8.7 ↙ 10.4 *
 Serie: 2 9.4 ↘ 7.5 ↗ 10.1 ↗ 9.9 ← 9.2 → 9.0 ↘ 9.3 ↗ 9.8 ↘ 10.3 * 9.8 ↑

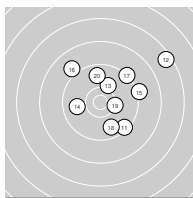
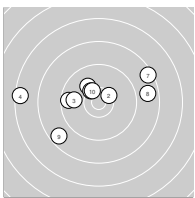

Serie: 1 10.2 ↘ 9.8 ← 10.0 ← 10.3 * 9.7 ↘ 10.1 ↗ 10.4 * 10.1 ↗ 10.5 * 10.4 *
 Serie: 2 10.0 ↘ 10.4 * 10.3 → 9.7 → 9.9 ↓ 10.9 * 10.6 * 10.6 * 10.6 * 9.7 ↑

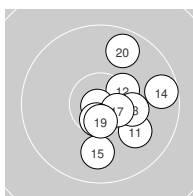
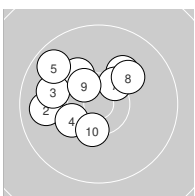

Serie: 1 10.0 ↘ 9.2 ← 9.4 ← 9.1 ↓ 8.8 ↓ 5.7 ↓ 9.4 ↑ 9.2 ← 8.6 → 9.5 ↓
 Serie: 2 9.7 ↗ 9.8 ↓ 10.3 * 9.4 ↖ 9.7 → 9.0 ↘ 8.4 → 7.2 ← 7.4 → 9.0 ←

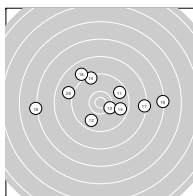
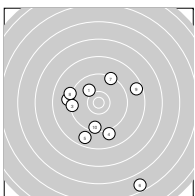

Ergebnis: **537** 181 Serien: 89 92
 185 94 91
 171 87 84
 Zähler: 17 27 13 2 1 0 Innenzehner: 10

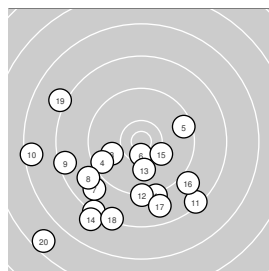
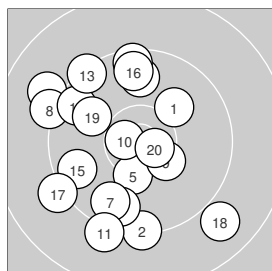
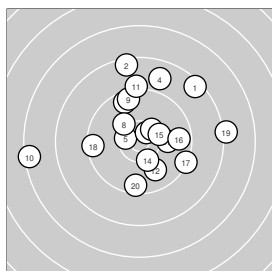

kniend Wertung

liegend Wertung

stehend Wertung

Serie: 1 8.5 ↗ 8.5 ↑ 9.6 ↖ 8.9 ↗ 10.5 * 10.6 * 10.4 * 10.2 ↘ 9.6 ↑ 7.4 ←
 Serie: 2 9.2 ↑ 9.9 ↘ 10.1 → 10.3 * 10.3 * 9.7 → 9.3 ↘ 9.5 ← 8.2 → 9.6 ↓

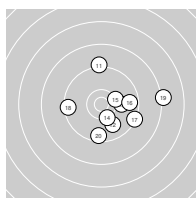
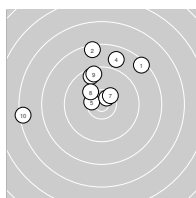

Serie: 1 10.1 ↗ 9.4 ↓ 9.8 ↑ 9.1 ↘ 10.3 * 9.7 ↓ 9.7 ↓ 9.2 ↘ 10.4 * 10.7 *
 Serie: 2 9.2 ↓ 9.6 ↘ 9.4 ↘ 9.5 ↑ 9.7 ← 9.7 ↑ 9.2 ← 8.9 ↘ 10.0 ↘ 10.7 *

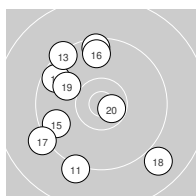
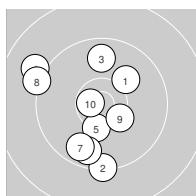

Serie: 1 9.2 ↓ 8.3 ↘ 10.0 ← 9.6 ← 9.6 → 10.5 * 8.9 ↘ 9.0 ← 8.5 ← 7.5 ←
 Serie: 2 8.4 ↘ 9.3 ↓ 10.1 ↓ 8.1 ↘ 10.2 ↘ 9.0 ↘ 8.9 ↓ 8.4 ↓ 8.1 ↘ 6.6 ↘

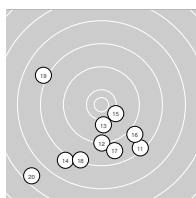
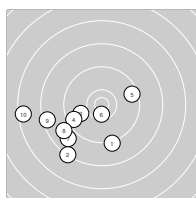

Ergebnis: **500** 167 Serien: 82 85
 185 94 91
 148 77 71
 Zähler: 14 23 7 8 4 2 Innenzehner: 5

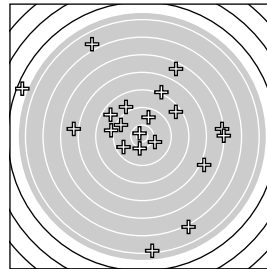
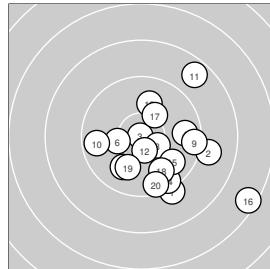
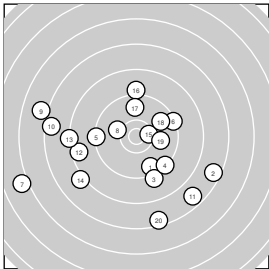

kniend Wertung

liegend Wertung

stehend Wertung

Serie: 1 9.6 ↘ 7.6 ➤ 9.1 ↘ 9.4 ↘ 9.4 ← 9.4 ➤ 6.0 ← 10.1 ↖ 7.0 ↖ 7.6 ←
 Serie: 2 7.7 ↘ 8.6 ← 8.3 ← 8.2 ↙ 10.5 * 9.1 ↑ 9.8 ↑ 9.8 ➤ 10.0 ➔ 7.5 ↓

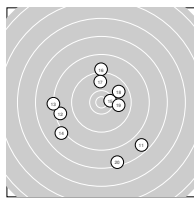
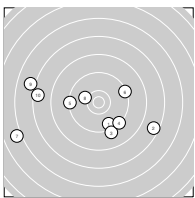

Serie: 1 9.2 ↘ 9.1 ➤ 10.9 * 9.7 ➔ 9.8 ↘ 10.3 ← 10.0 ↙ 10.4 * 9.5 ➔ 9.7 ←
 Serie: 2 8.7 ↗ 10.6 * 10.0 ↑ 9.5 ↘ 9.8 ↘ 7.5 ➤ 10.3 ↗ 9.9 ↘ 10.0 ↙ 9.6 ↓

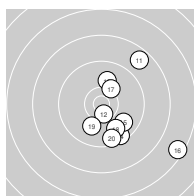
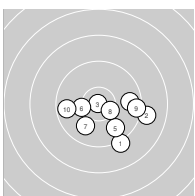

Serie: 1 6.4 ➔ 3.6 ↖ 9.1 ← 8.2 ↗ 9.6 ↖ 6.3 ➔ 9.0 ↖ 10.2 ➤ 7.1 ➤ 10.7 *
 Serie: 2 7.0 ← 9.8 ↗ 9.7 ↙ 8.6 ↗ 8.8 ↖ 4.4 ↓ 6.7 ↗ 5.0 ↖ 5.2 ↘ 10.3 ↓

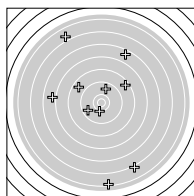
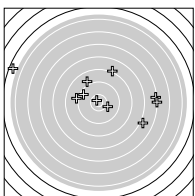

Ergebnis: **526** 175 Serien: 88 87
 177 87 90
 174 89 85
 Zähler: 10 29 18 3 0 0 Innenzehner: 7

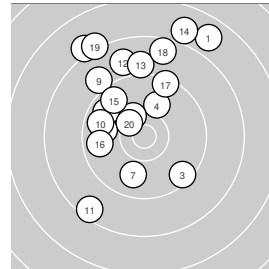
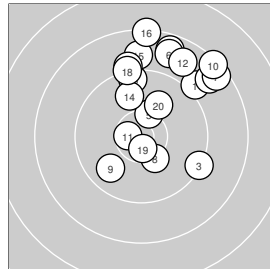
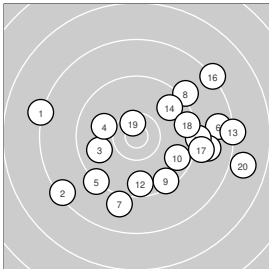

kniend Wertung

liegend Wertung

stehend Wertung

Serie: 1 8.3 ↖ 8.4 ↙ 9.9 ↖ 10.0 ↖ 9.3 ↙ 8.7 → 9.0 ↓ 9.2 ↗ 9.5 ↘ 9.7 →
 Serie: 2 9.0 → 9.7 ↓ 8.3 → 9.8 ↗ 9.3 → 8.3 ↗ 9.1 → 9.5 → 10.6 * 7.9 →

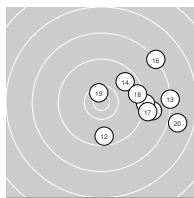
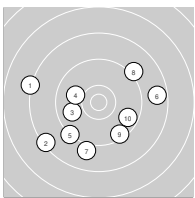

Serie: 1 9.1 ↗ 8.7 ↑ 9.3 → 8.7 ↗ 10.4 * 8.8 ↑ 8.6 ↗ 10.3 * 9.9 ↙ 8.4 ↗
 Serie: 2 10.6 * 8.8 ↑ 9.5 ↑ 9.9 ↑ 8.9 ↑ 8.4 ↑ 9.2 ↑ 9.3 ↑ 10.6 * 10.1 ↑

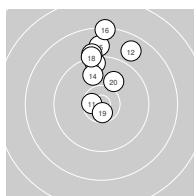
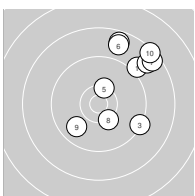

Serie: 1 7.8 ↗ 8.1 ↘ 9.5 ↘ 10.0 ↑ 9.7 ↘ 10.3 * 9.9 ↓ 9.9 ← 9.0 ↘ 9.7 ←
 Serie: 2 8.5 ↙ 8.9 ↑ 9.0 ↑ 7.9 ↑ 9.7 ↘ 9.8 ← 9.4 ↑ 8.6 ↑ 8.2 ↘ 10.4 *

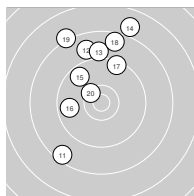
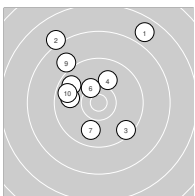

Ergebnis: **509** 167 Serien: 83 84
 188 96 92
 154 78 76
 Zähler: 16 19 14 7 1 1 Innenzehner: 8

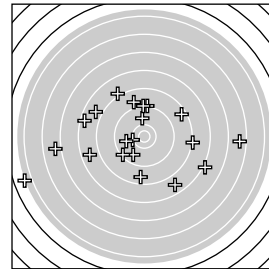
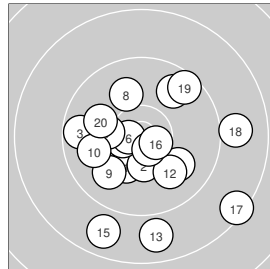
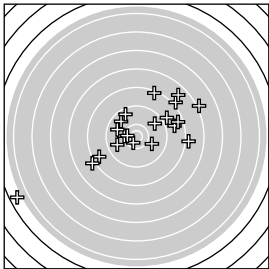

kniend Wertung

liegend Wertung

stehend Wertung

Serie: 1 9.8 ↙ 10.0 ↘ 10.6 * 8.1 → 10.3 * 9.8 ↘ 8.8 → 8.6 → 8.4 ↑ 3.7 ↙
 Serie: 2 9.8 ↙ 9.6 ↘ 8.7 ↙ 10.5 * 8.2 ↙ 9.7 ↗ 8.1 ↗ 9.0 ↗ 7.2 ↗ 7.8 ↗

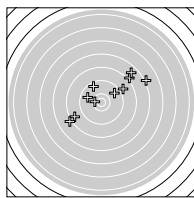
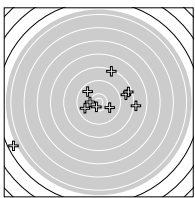

Serie: 1 10.3 ↘ 10.4 * 9.7 ← 10.6 * 9.8 ↗ 10.7 * 10.2 ← 10.0 ↑ 9.9 ↙ 9.9 ←
 Serie: 2 10.0 ↘ 10.0 ↘ 8.9 ↓ 10.6 * 8.8 ↘ 10.6 * 8.5 ↘ 9.0 → 9.6 ↗ 10.0 ↘

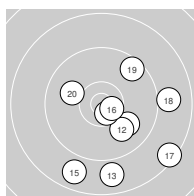
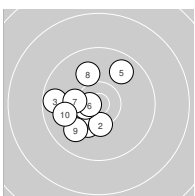

Serie: 1 6.0 ← 7.2 ↘ 9.0 ↑ 7.8 ← 9.8 ↘ 7.9 ↘ 8.3 → 10.3 ← 7.8 ↘ 8.6 ↗
 Serie: 2 9.4 ↘ 7.5 ← 9.9 ← 3.9 ← 9.3 ↑ 8.2 ↘ 9.9 ↑ 5.7 → 9.3 ↑ 8.7 ↓

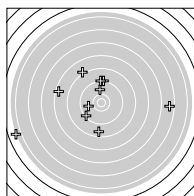
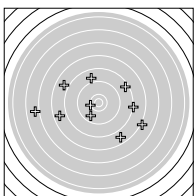

Ergebnis: **546** 181 Serien: 91 90
 185 91 94
 180 90 90
 Zähler: 17 35 6 1 1 0 Innenzehner: 4

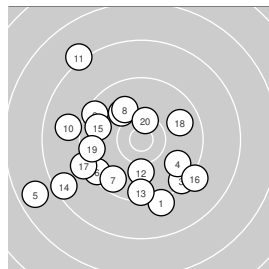
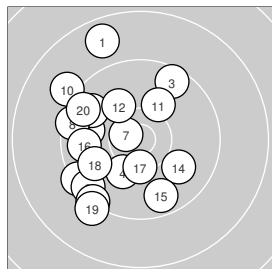
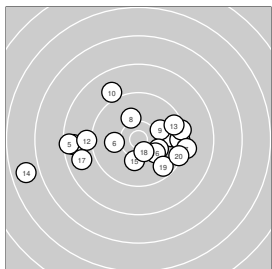

kniend Wertung

liegend Wertung

stehend Wertung

Serie: 1 9.8 → 9.5 → 8.7 ← 9.4 → 8.5 ← 10.1 ← 9.2 → 10.2 ↗ 10.1 → 9.0 ↘
 Serie: 2 10.2 ↘ 9.1 ← 9.6 → 6.8 ← 10.2 ↓ 10.2 ↘ 8.8 ← 10.5 * 9.7 ↘ 9.4 →

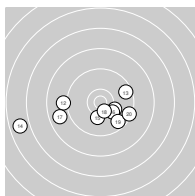
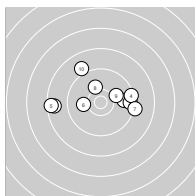

Serie: 1 8.8 ↗ 9.8 ← 9.6 ↗ 10.2 ↘ 9.4 ↘ 9.8 ↘ 10.6 * 9.5 ← 9.5 ↘ 9.1 ↘
 Serie: 2 10.1 ↗ 10.1 ↘ 9.3 ↘ 10.0 ↘ 9.7 ↓ 9.8 ← 10.4 * 9.9 ↘ 9.2 ↘ 9.6 ↘

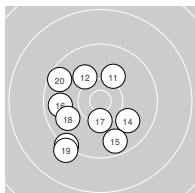
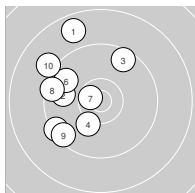

Serie: 1 9.2 ↓ 10.1 ↘ 9.4 ↘ 9.8 ↘ 7.8 ← 9.5 ↘ 9.7 ↘ 10.0 ↘ 9.5 ↘ 9.0 ←
 Serie: 2 8.2 ↘ 10.1 ↓ 9.5 ↓ 8.5 ↘ 9.8 ← 9.2 ↘ 9.3 ↘ 9.8 → 9.6 ← 10.4 *

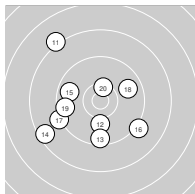
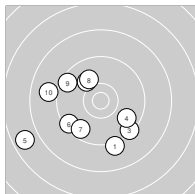

Ergebnis: **538** 170 Serien: 85 85
 187 95 92
 181 91 90
 Zähler: 18 28 10 2 2 0 Innenzehner: 8

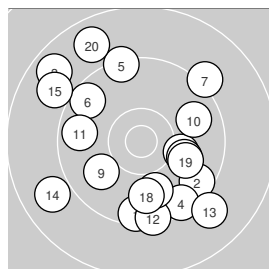
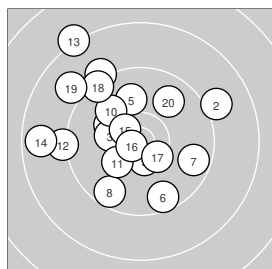
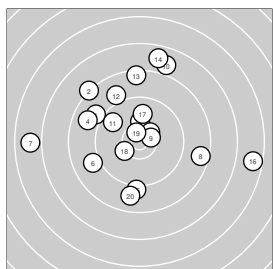

kniend Wertung

liegend Wertung

stehend Wertung

Serie: 1 9.0 ↘ 8.3 ↘ 10.2 ↑ 8.9 ↖ 10.4 * 9.0 ↙ 6.9 ← 8.6 → 10.5 * 7.9 ↑
 Serie: 2 9.7 ↘ 9.0 ↘ 8.5 ↑ 7.8 ↑ 9.2 ↓ 6.7 → 9.9 ↑ 10.3 * 10.6 * 8.9 ↓

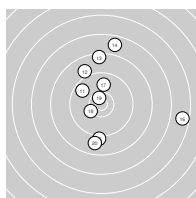
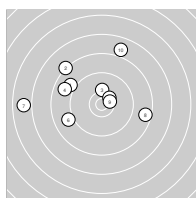

Serie: 1 10.2 ↘ 9.1 ↗ 10.3 ← 9.2 ↘ 10.0 ↑ 9.6 ↓ 9.7 → 9.6 ↙ 10.5 * 10.0 ↘
 Serie: 2 10.3 ↗ 9.2 ← 8.3 ↘ 8.7 ← 10.5 * 10.7 * 10.4 * 9.4 ↘ 9.0 ↘ 9.9 ↗

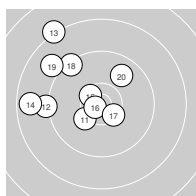
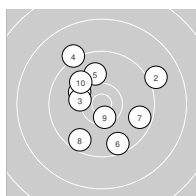

Serie: 1 9.5 ↓ 9.6 ↘ 8.8 ↘ 9.5 ↓ 9.4 ↑ 9.6 ↘ 9.2 ↗ 10.1 → 10.0 ↙ 9.8 ↗
 Serie: 2 9.7 ← 9.4 ↓ 9.0 ↘ 8.9 ↖ 9.0 ↘ 9.9 ↓ 10.0 → 9.9 ↓ 10.0 → 8.8 ↘

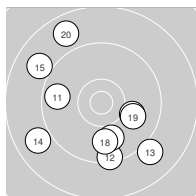
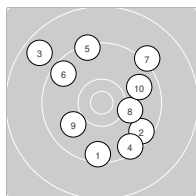

Ergebnis: **555** 178 Serien: 91 87
 190 95 95
 187 93 94
 Zähler: 29 20 8 3 0 0 Innenzehner: 12

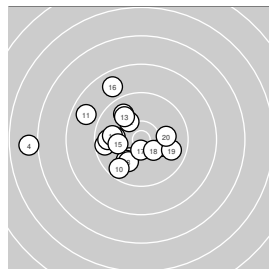
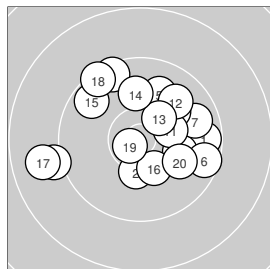
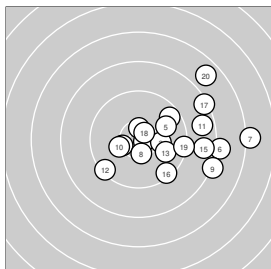

kniend Wertung

liegend Wertung

stehend Wertung

Serie: 1 10.4 * 10.8 * 10.2 → 9.7 ↗ 9.9 ↗ 8.2 → 7.1 → 10.5 * 8.2 → 10.2 ↖
 Serie: 2 8.7 → 9.4 ↖ 9.9 → 10.6 * 8.7 → 9.5 ↘ 8.4 ↗ 10.7 * 9.4 → 7.8 ↗

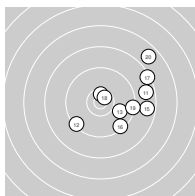
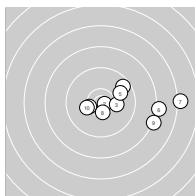

Serie: 1 9.7 → 10.3 * 9.5 ↖ 10.1 → 10.0 ↗ 9.6 → 9.8 → 10.3 ↗ 9.1 ↖ 10.1 ↗
 Serie: 2 10.3 * 9.9 ↗ 10.4 * 10.0 ↑ 9.7 ↖ 10.3 * 8.9 ↖ 9.5 ↖ 10.7 * 10.0 ↘

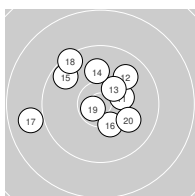
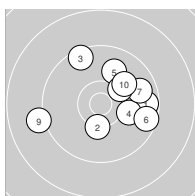

Serie: 1 9.9 ↖ 9.7 ↖ 10.2 ↖ 7.0 ↖ 10.1 → 10.0 ↖ 10.0 ↖ 10.0 ↖ 9.8 ↖ 9.7 ↖
 Serie: 2 8.8 ↖ 10.2 ↖ 10.0 ↖ 9.9 ↖ 10.1 ↖ 8.8 ↖ 10.6 * 10.4 * 9.8 → 10.1 →

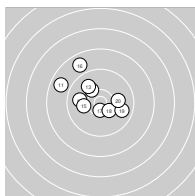
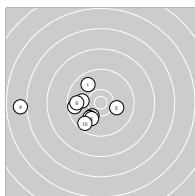

Ergebnis: **544** 180 Serien: 88 92
 191 96 95
 173 90 83
 Zähler: 19 30 8 2 1 0 Innenzehner: 11

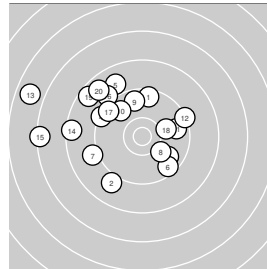
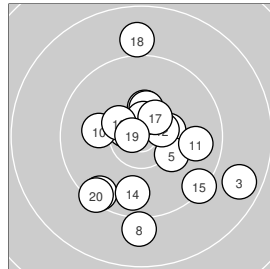
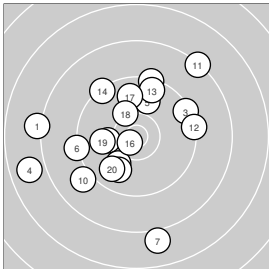

kniend Wertung

liegend Wertung

stehend Wertung

Serie: 1 8.2 ← 9.4 ↑ 9.4 ↗ 7.8 ← 9.9 ↑ 9.3 ← 8.0 ↓ 10.2 ← 10.0 ↘ 9.1 ↗
 Serie: 2 8.3 ↗ 9.3 → 9.6 ↑ 9.4 ↘ 9.9 ↘ 10.7 * 9.8 ↑ 10.2 ↘ 10.0 ← 9.8 ↘

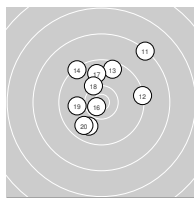
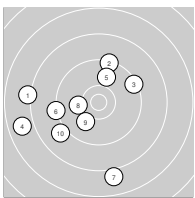

Serie: 1 10.4 * 10.4 * 8.8 ↘ 10.4 * 10.2 ↘ 10.6 * 9.5 ↘ 9.1 ↓ 10.7 * 10.1 ←
 Serie: 2 9.8 → 10.5 * 10.6 * 9.8 ↓ 9.4 ↘ 10.4 * 10.5 * 9.0 ↑ 10.8 * 9.4 ↘

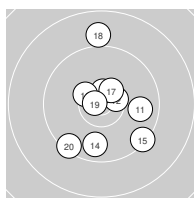
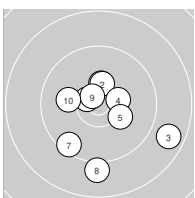

Serie: 1 9.6 ↑ 9.0 ↘ 9.8 ↘ 9.4 ↘ 8.9 ↘ 9.6 ↘ 9.1 ← 10.1 ↘ 9.7 ↑ 9.8 ↘
 Serie: 2 9.7 → 9.3 → 6.8 ← 8.5 ← 7.4 ← 9.1 ↘ 9.5 ↘ 10.1 → 8.6 ↘ 8.8 ↘

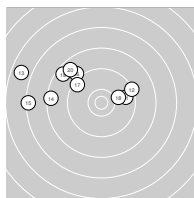
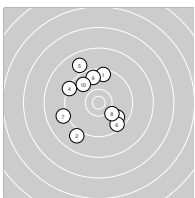

Ergebnis: **518** 162 Serien: 82 80
 187 93 94
 169 82 87
 Zähler: 15 22 13 8 1 0 Innenzehner: 4

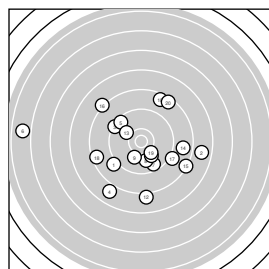
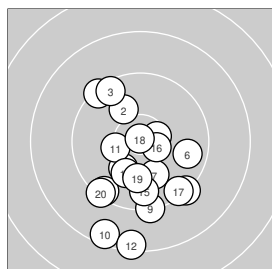
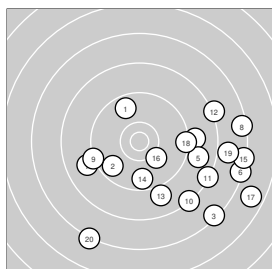

kniend Wertung

liegend Wertung

stehend Wertung

Serie: 1 9.7 ↗ 9.7 ↘ 7.4 ↘ 9.1 → 8.9 → 7.4 → 9.0 ← 7.4 → 9.3 ← 8.3 ↘
 Serie: 2 8.3 ↘ 8.2 → 9.0 ↘ 9.7 ↓ 7.4 → 10.2 ↘ 6.7 ↘ 9.4 → 7.9 → 7.3 ↘

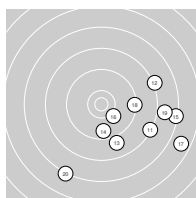
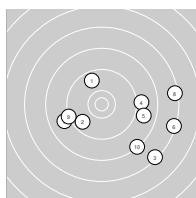

Serie: 1 9.4 ↘ 10.1 ↘ 9.5 ↘ 10.2 ↘ 9.5 ↘ 9.8 → 10.1 ↘ 10.5 * 9.3 ↓ 8.6 ↘
 Serie: 2 10.3 * 8.5 ↓ 10.1 ↘ 9.3 ↘ 9.7 ↓ 10.5 * 9.4 ↘ 10.9 * 10.1 ↓ 9.4 ↘

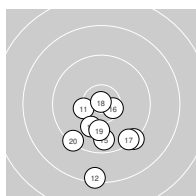
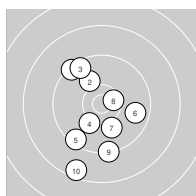

Serie: 1 9.1 ← 7.8 → 9.4 ↘ 7.9 ↘ 9.5 ↘ 4.9 ← 9.6 ↘ 10.0 ↓ 10.1 ↘ 8.6 ↗
 Serie: 2 10.1 ↘ 8.1 ↓ 10.1 ↘ 8.8 → 8.3 ↘ 8.2 ↘ 9.1 ↘ 8.5 ← 10.2 ↘ 8.5 ↗

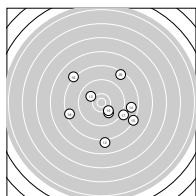
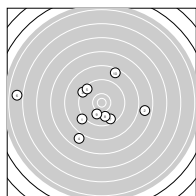

Ergebnis: **549** 186 Serien: 93 93
 196 98 98
 167 80 87

Zähler: 29 19 8 2 1 0 Innenzehner: 22

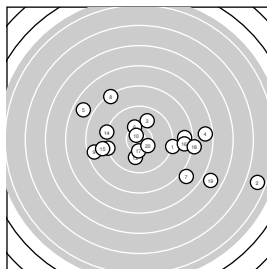
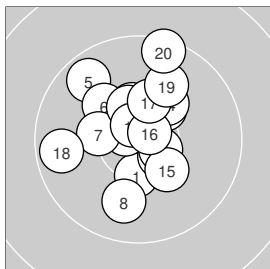
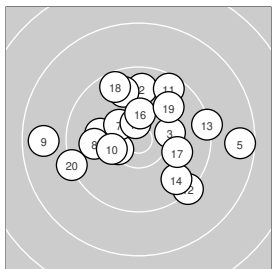

kniend Wertung

liegend Wertung

stehend Wertung

Serie: 1 10.4 * 9.8 ↑ 10.2 → 9.8 ↖ 8.6 → 10.1 ← 10.4 * 9.9 ← 8.8 ← 10.3 *
 Serie: 2 9.6 ↗ 9.4 ↘ 9.4 → 9.7 ↘ 10.6 * 10.4 * 10.0 → 9.6 ↖ 9.9 ↗ 9.3 ←

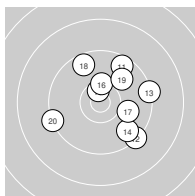
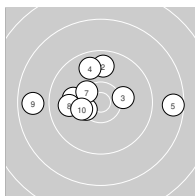

Serie: 1 10.4 * 10.5 * 10.4 * 10.7 * 9.7 ↖ 10.2 ↖ 10.3 * 9.9 ↓ 10.6 * 10.3 *
 Serie: 2 10.7 * 10.4 * 10.7 * 10.2 ↗ 10.3 * 10.7 * 10.3 * 9.7 ← 10.0 ↗ 9.5 ↑

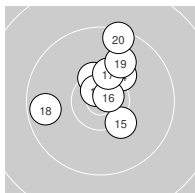
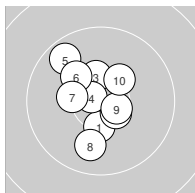

Serie: 1 9.3 → 4.7 → 9.9 ↗ 7.7 → 7.8 ↖ 10.3 * 8.0 ↘ 8.4 ↖ 8.6 ← 10.7 *
 Serie: 2 8.7 → 10.0 ↓ 9.3 ← 9.3 ← 9.1 ← 8.7 → 10.4 * 8.2 → 6.9 ↘ 10.4 *

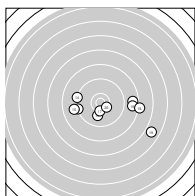
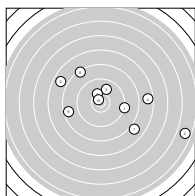

Ergebnis: **548** 183 Serien: 91 92
 190 96 94
 175 88 87
 Zähler: 19 33 6 1 1 0 Innenzehner: 9

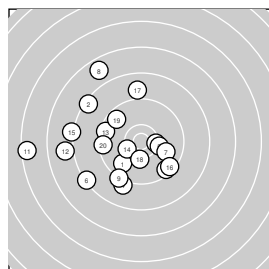
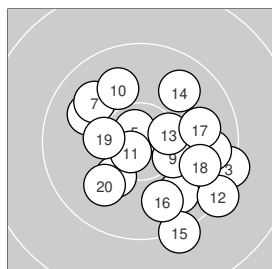
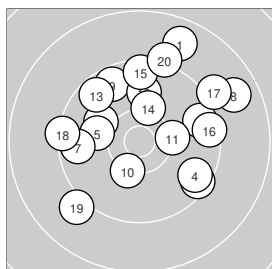

kniend Wertung

liegend Wertung

stehend Wertung

Serie: 1 8.8 ↗ 9.5 ↘ 10.1 ↖ 9.6 ↘ 10.1 ← 9.7 → 9.7 ← 8.8 ↗ 9.7 ↘ 10.3 *
 Serie: 2 10.3 → 9.9 ↑ 9.7 ↘ 10.3 ↑ 9.5 ↑ 9.5 → 9.1 ↗ 9.4 ← 9.1 ↖ 9.2 ↑

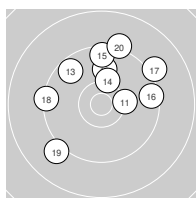
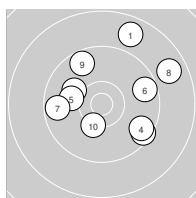

Serie: 1 10.5 * 9.9 ↘ 9.4 → 10.0 ↖ 10.7 * 9.8 → 9.9 ↘ 10.2 ↖ 10.3 * 10.0 ↘
 Serie: 2 10.7 * 9.4 ↘ 10.5 * 9.9 ↗ 9.3 ↘ 9.9 ↘ 9.9 → 9.9 → 10.3 * 10.0 ↖

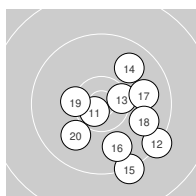
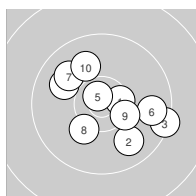

Serie: 1 9.8 ↖ 8.4 ↘ 10.4 * 9.1 ↖ 10.2 → 8.4 ↖ 9.9 → 7.7 ↘ 9.3 ↖ 9.5 ↘
 Serie: 2 6.5 ← 8.0 ← 9.5 ← 10.3 * 8.2 ← 9.5 ↘ 9.0 ↑ 10.3 ↓ 9.7 ↘ 9.5 ←

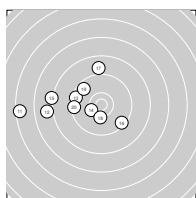
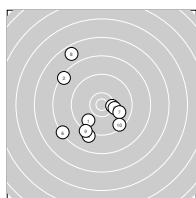

Ergebnis: **534** 176 Serien: 87 89
 192 98 94
 166 83 83

Zähler: 17 29 10 2 1 0 Innenzehner: 10

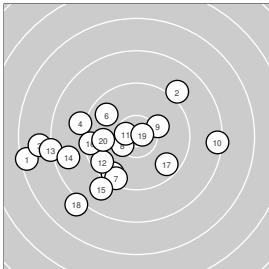

kniend Wertung

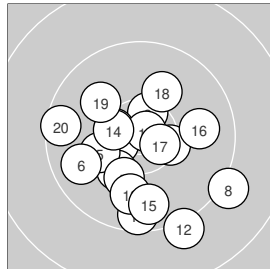

liegend Wertung

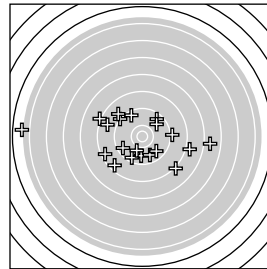

stehend Wertung

Serie: 1 7.5 ← 9.1 ↗ 7.9 ← 9.2 ↖ 9.6 ↙ 9.8 ↘ 9.5 ↘ 10.4 * 10.2 ↗ 8.4 →
 Serie: 2 10.6 * 9.6 ↙ 8.3 ← 8.7 ← 9.0 ↙ 9.5 ← 9.7 ↘ 8.1 ↙ 10.8 * 9.9 ←

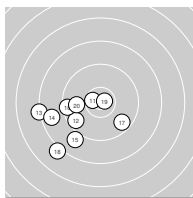
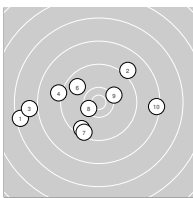

Serie: 1 10.6 * 10.5 * 10.2 ↙ 10.5 * 10.2 ↖ 9.8 ↖ 10.2 ↘ 9.2 ↘ 10.4 * 10.8 *
 Serie: 2 9.6 ↓ 9.2 ↘ 9.9 ↓ 10.5 * 9.8 ↓ 9.9 → 10.6 * 10.1 ↗ 10.0 ↘ 9.6 ←

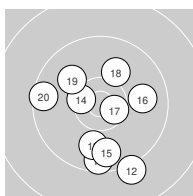
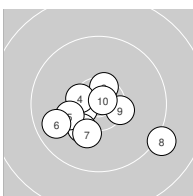

Serie: 1 9.6 ↙ 9.3 ↘ 9.8 ↓ 9.5 ↘ 9.0 ↘ 8.5 ↖ 9.8 ↘ 3.8 ← 9.6 ↗ 9.8 ↘
 Serie: 2 8.1 → 8.2 ↘ 9.6 ↙ 10.1 ↘ 8.2 ↖ 6.9 → 9.2 → 9.8 ↗ 8.6 ↙ 8.8 ←

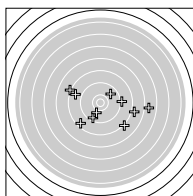
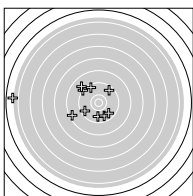

Ergebnis: **545** 178 Serien: 89 89
 195 98 97
 172 82 90
 Zähler: 26 18 12 3 1 0 Innenzehner: 17

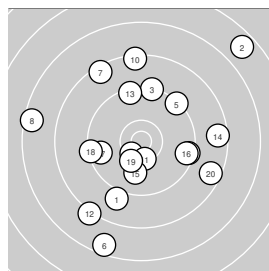
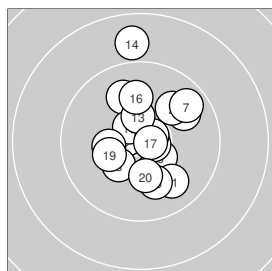
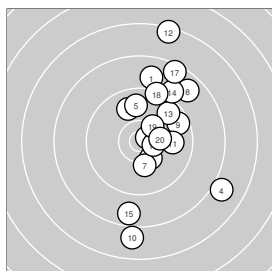

kniend Wertung

liegend Wertung

stehend Wertung

Serie: 1 8.9 ↑ 9.9 ↘ 10.3 * 8.0 ↘ 9.8 ↑ 10.7 * 10.2 ↓ 8.8 ↗ 9.6 ↗ 8.0 ↓
 Serie: 2 9.9 → 7.4 ↑ 9.7 ↗ 9.1 ↗ 8.7 ↓ 10.5 * 8.5 ↑ 9.4 ↑ 10.3 * 10.3 *

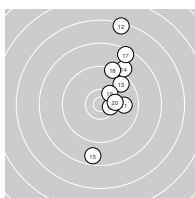
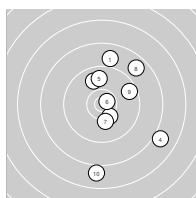

Serie: 1 9.9 ↗ 10.0 ↗ 10.3 * 10.0 ↘ 10.7 * 10.4 * 9.7 ↗ 10.3 * 10.7 * 10.6 *
 Serie: 2 9.9 ↘ 10.7 * 10.4 * 8.9 ↑ 10.1 ↓ 10.0 ↑ 10.7 * 10.3 * 10.3 ↖ 10.2 ↓

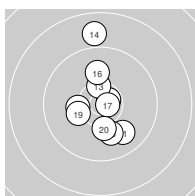
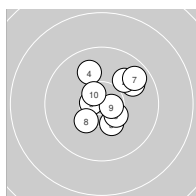

Serie: 1 9.0 ↓ 6.7 ↗ 9.3 ↑ 10.5 * 9.4 ↗ 7.6 ↓ 8.5 ↘ 7.5 ↖ 9.5 → 8.4 ↑
 Serie: 2 10.4 * 8.2 ↓ 9.4 ↑ 8.6 → 10.0 ↓ 9.5 → 9.7 ↖ 9.4 ↖ 10.3 ↓ 8.6 →

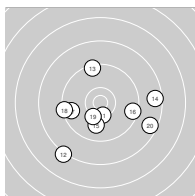
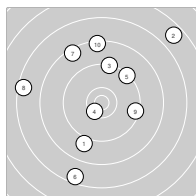

Ergebnis: **530** 185 Serien: 93 92
 191 95 96
 154 73 81

Zähler: 20 22 12 3 2 0 Innenzehner: 11

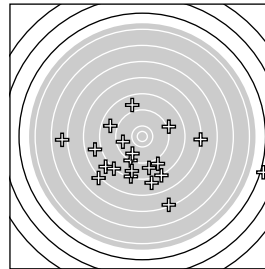
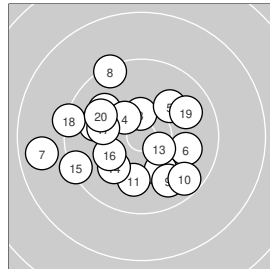
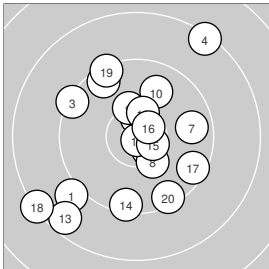

kniend Wertung

liegend Wertung

stehend Wertung

Serie: 1 9.1 ↙ 10.6 * 9.4 ↘ 8.4 ↗ 10.6 * 9.6 ↖ 9.8 → 10.3 * 10.3 * 9.9 ↗
 Serie: 2 10.9 * 10.4 * 8.6 ↙ 9.5 ↓ 10.6 * 10.6 * 9.6 ↘ 8.3 ↙ 9.4 ↖ 9.5 ↘

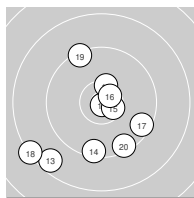
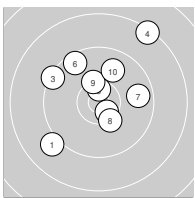

Serie: 1 10.0 ↘ 10.1 ↘ 10.5 * 10.4 * 10.1 ↗ 10.0 → 8.8 ← 9.4 ↖ 9.9 ↘ 9.7 ↘
 Serie: 2 10.0 ↓ 9.9 ← 10.5 * 10.1 ↙ 9.4 ← 10.2 ↙ 10.1 ← 9.4 ← 9.9 → 10.0 ↘

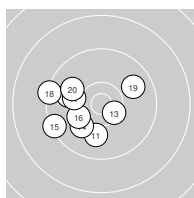
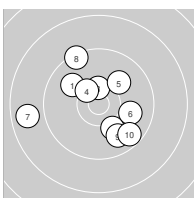

Serie: 1 8.9 ↖ 7.3 → 7.2 ↙ 8.4 ↓ 8.9 ↖ 9.0 ↓ 3.1 → 8.0 ↙ 9.0 ↘ 6.0 ←
 Serie: 2 9.7 ← 8.3 ↘ 9.3 ↙ 8.0 ↓ 6.4 ↓ 9.2 → 9.7 ↙ 7.9 ← 8.7 ↓ 8.3 ↙

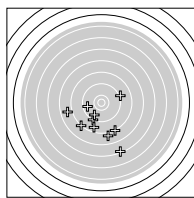
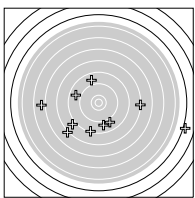

Ergebnis: **510** 164 Serien: 80 84
 184 92 92
 162 85 77
 Zähler: 16 17 14 10 1 1 Innenzehner: 4

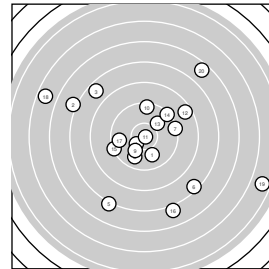
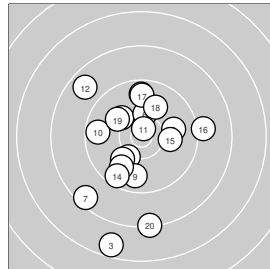
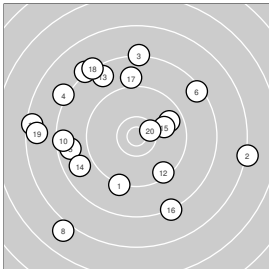

kniend Wertung

liegend Wertung

stehend Wertung

Serie: 1 9.3 ↘ 7.2 → 8.3 ↑ 8.2 ↖ 8.7 ← 8.5 ↗ 8.2 ↘ 7.0 ↙ 9.8 → 8.5 ←
 Serie: 2 7.5 ← 9.5 ↘ 8.7 ↘ 8.8 ← 10.0 → 8.3 ↘ 9.0 ↑ 8.3 ↘ 7.7 ← 10.5 *

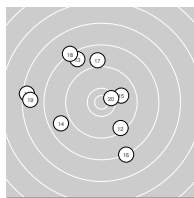
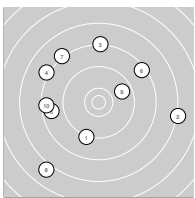

Serie: 1 10.2 ↘ 10.2 ↙ 7.7 ↘ 10.1 ↙ 10.0 → 10.3 ↑ 8.5 ↙ 9.7 ↑ 9.8 ↓ 9.7 ←
 Serie: 2 10.7 * 8.8 ↘ 9.9 ↙ 9.6 ↙ 10.1 → 9.1 → 9.7 ↑ 10.0 ↑ 10.1 ↘ 8.3 ↓

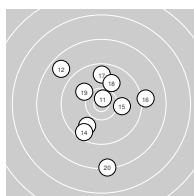
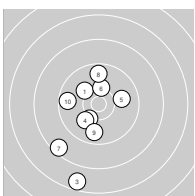

Serie: 1 10.0 ↘ 7.1 ↘ 7.7 ↘ 10.4 * 7.2 ↙ 7.5 ↘ 9.4 → 9.9 ↙ 10.1 ↙ 9.5 ↑
 Serie: 2 10.9 * 8.6 → 10.0 ↗ 9.4 ↗ 9.4 ← 7.1 ↘ 9.7 ← 5.7 ↖ 4.7 → 6.6 ↗

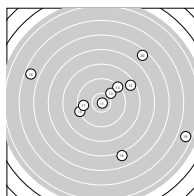
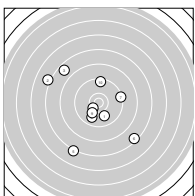

Ergebnis: **559** 194 Serien: 95 99
 190 95 95
 175 89 86
 Zähler: 30 21 7 2 0 0 Innenzehner: 12

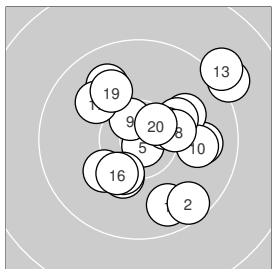

kniend Wertung

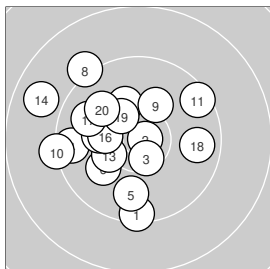

liegend Wertung

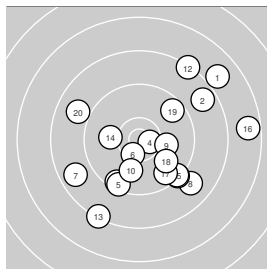

stehend Wertung

Serie: 1 9.8 ↘ 9.6 ↘ 9.9 → 10.3 ↙ 10.8 * 9.2 ↗ 9.9 ↖ 10.1 ↗ 10.6 * 10.0 →
 Serie: 2 10.2 ↙ 10.2 → 9.2 ↗ 10.3 * 10.5 * 10.3 ↙ 10.0 ↖ 10.3 * 10.0 ↖ 10.6 *

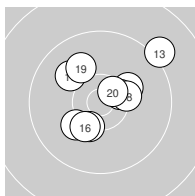
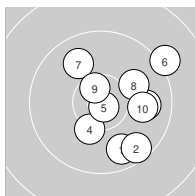

Serie: 1 9.5 ↓ 10.8 * 10.5 * 9.6 ← 9.9 ↓ 10.1 ↙ 10.2 ↖ 9.2 ↘ 10.2 ↗ 9.3 ←
 Serie: 2 9.5 ↗ 10.3 ← 10.3 * 8.9 ↖ 10.2 ← 10.3 ← 9.9 ↖ 9.8 → 10.4 * 10.0 ↖

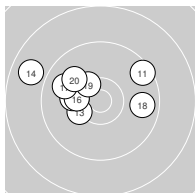
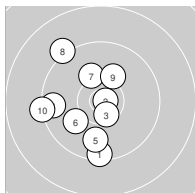

Serie: 1 7.9 ↗ 8.7 ↗ 9.5 ↙ 10.6 * 9.5 ↙ 10.5 * 8.8 ↙ 8.9 ↘ 10.1 → 10.0 ↙
 Serie: 2 9.4 ↘ 8.4 ↗ 8.4 ↙ 10.1 ← 9.4 ↘ 7.7 → 9.7 ↘ 9.9 ↘ 9.6 ↗ 8.9 ↖

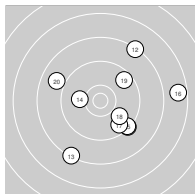
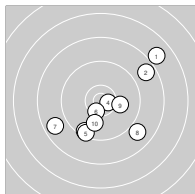

Ergebnis: **515** 184 Serien: 92 92
 190 93 97
 141 72 69
 Zähler: 20 21 8 5 1 3 Innenzehner: 12

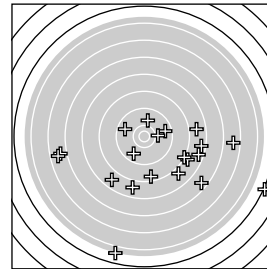
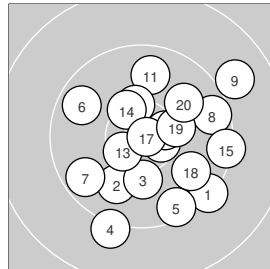
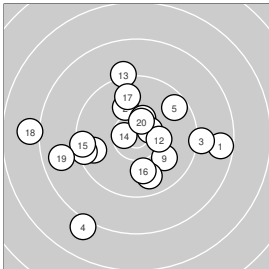

kniend Wertung

liegend Wertung

stehend Wertung

Serie: 1 8.6 → 10.1 ↘ 9.2 → 8.1 ↙ 9.7 ↗ 9.7 ↖ 10.4 * 10.6 * 10.0 ↘ 9.5 ↖
 Serie: 2 9.8 ↘ 10.3 * 9.2 ↗ 10.6 * 9.5 ↖ 10.0 ↘ 9.8 ↗ 8.0 ↖ 8.8 ↖ 10.5 *

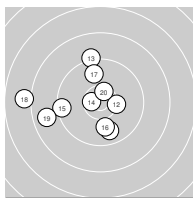
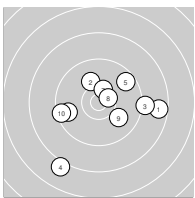

Serie: 1 9.4 ↘ 10.0 ↙ 10.2 ↓ 9.2 ↙ 9.5 ↓ 9.7 ↖ 9.7 ↖ 9.6 → 9.0 ↗ 10.6 *
 Serie: 2 9.8 ↗ 10.4 * 10.5 * 10.4 * 9.4 → 10.5 * 10.9 * 9.9 ↘ 10.3 * 10.0 ↗

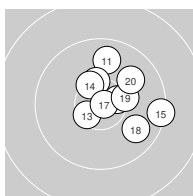
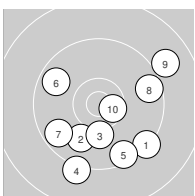

Serie: 1 3.2 ↘ 7.9 → 6.6 ↘ 9.7 ↖ 5.7 → 7.9 ↓ 10.0 ↑ 8.0 ↘ 8.1 ↘ 9.7 →
 Serie: 2 5.9 ↖ 5.8 ↖ 7.6 → 7.8 ↙ 10.1 → 8.3 ↘ 7.6 → 9.8 ↙ 8.6 ↓ 3.9 ↓

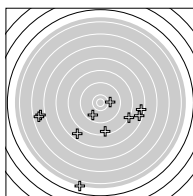
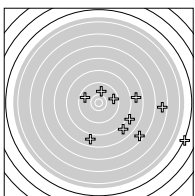

Ergebnis: **553** 183 Serien: 94 89
 198 100 98
 172 84 88
 Zähler: 32 13 11 4 0 0 Innenzehner: 19

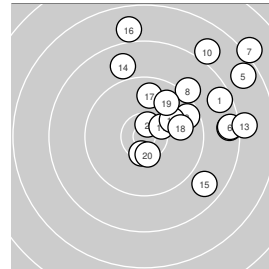
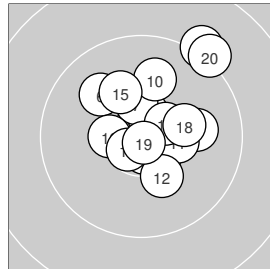
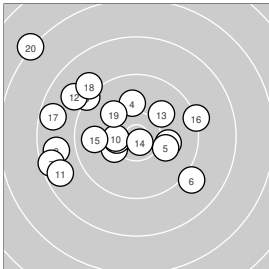

kniend Wertung

liegend Wertung

stehend Wertung

Serie: 1 10.3 ↙ 10.1 → 8.8 ← 10.1 ↑ 10.1 → 9.1 ↘ 8.6 ← 9.3 ↘ 10.4 * 10.4 *
 Serie: 2 8.7 ↙ 9.0 ↘ 10.1 ↗ 10.8 * 9.8 ← 9.3 → 8.7 ← 9.1 ↘ 10.1 ↘ 7.3 ↘

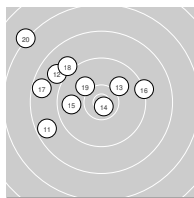
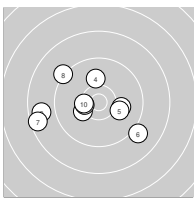

Serie: 1 10.6 * 10.8 * 10.0 → 10.6 * 10.6 * 10.0 ↘ 10.4 * 10.5 * 10.7 * 10.0 ↑
 Serie: 2 10.4 * 10.2 ↘ 10.5 * 9.2 ↗ 10.2 ↘ 10.4 * 10.6 * 10.2 → 10.8 * 9.2 ↗

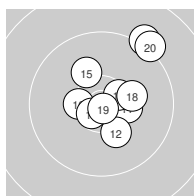
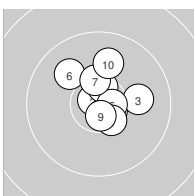

Serie: 1 8.6 ↗ 10.6 * 9.6 ↗ 8.6 → 7.7 ↗ 8.6 → 7.2 ↗ 9.2 ↗ 10.5 * 8.0 ↗
 Serie: 2 10.4 * 10.1 ↗ 8.1 → 8.9 ↘ 8.8 ↘ 7.9 ↑ 9.8 ↑ 9.9 → 9.8 ↗ 10.4 *

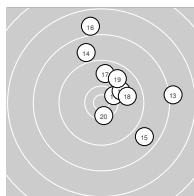
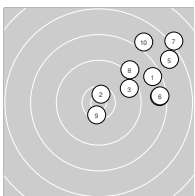

Ergebnis: **540** 173 Serien: 89 84
 193 96 97
 174 88 86
 Zähler: 23 22 10 2 3 0 Innenzehner: 16

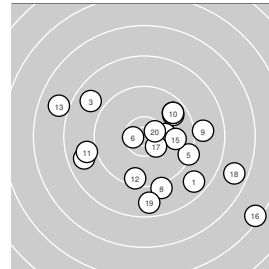
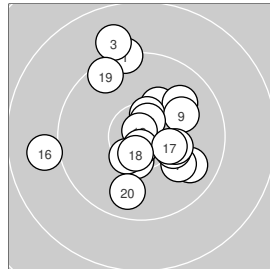
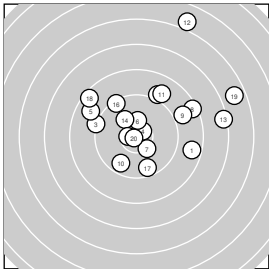

kniend Wertung

liegend Wertung

stehend Wertung

Serie: 1 8.7 → 9.1 ↗ 9.3 ↖ 10.6 * 8.9 ↖ 10.3 * 10.3 * 8.5 → 8.9 → 9.7 ↘
 Serie: 2 9.0 ↗ 6.0 ↗ 7.4 → 10.1 ↘ 10.6 * 9.4 ↘ 9.6 ↓ 8.5 ↖ 6.7 → 10.8 *

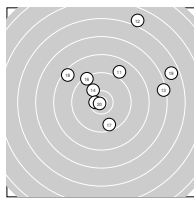
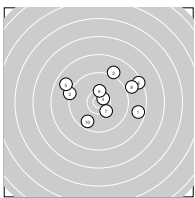

Serie: 1 9.3 ↑ 10.2 ↑ 9.0 ↑ 9.8 ↘ 10.5 * 9.9 ↗ 10.0 ↘ 10.5 * 10.1 ↗ 10.3 ↘
 Serie: 2 10.3 → 10.6 * 10.8 * 10.7 * 10.5 * 9.0 ← 10.4 * 10.6 * 9.6 ↘ 9.8 ↓

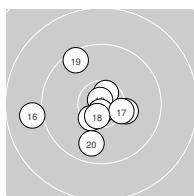
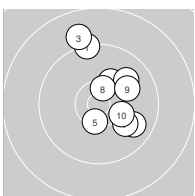

Serie: 1 8.7 ↘ 9.8 ↗ 8.8 ↖ 8.8 ← 9.4 → 10.6 * 9.7 ↗ 9.2 ↓ 9.0 → 9.7 ↗
 Serie: 2 9.0 ← 9.5 ↓ 8.0 ← 10.3 → 9.9 → 6.5 ↘ 10.4 * 7.7 → 8.8 ↓ 10.6 *

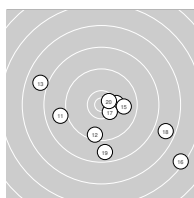
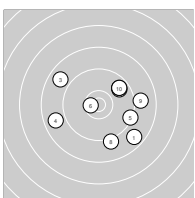

Ergebnis: **533** 177 Serien: 82 95
 186 91 95
 170 87 83

Zähler: 23 15 16 4 2 0 Innenzehner: 11

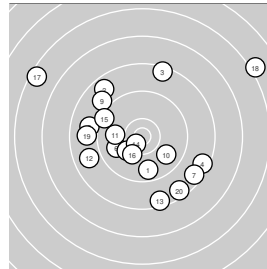
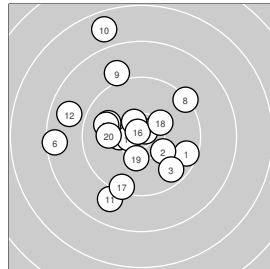
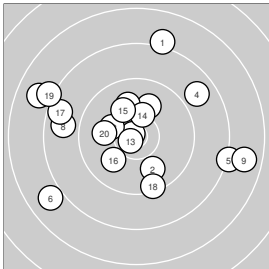

kniend Wertung

liegend Wertung

stehend Wertung

Serie: 1 8.2 ↑ 9.9 ↓ 7.9 ↖ 8.8 ↗ 8.2 → 7.9 ↙ 10.0 ↑ 8.8 ← 7.8 → 10.0 ↑
 Serie: 2 10.8 * 10.2 ↖ 10.7 * 10.3 * 10.1 ↖ 10.0 ↙ 8.7 ← 9.5 ↓ 8.2 ↖ 10.0 ←

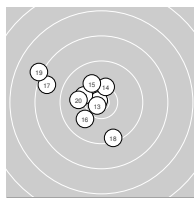
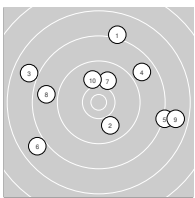

Serie: 1 9.6 → 10.2 ↘ 9.7 ↘ 10.8 * 10.3 * 8.5 ← 10.0 ↖ 9.4 ↗ 9.1 ↑ 7.8 ↑
 Serie: 2 9.0 ↓ 8.8 ← 9.9 ← 10.6 * 10.5 * 10.8 * 9.4 ↓ 10.3 * 10.3 * 10.0 ←

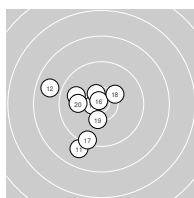
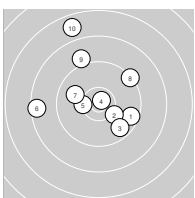

Serie: 1 9.7 ↓ 8.7 ↖ 8.5 ↑ 8.5 ↘ 9.0 ← 9.9 ↙ 8.6 ↘ 10.2 ↙ 9.0 ↖ 9.9 ↘
 Serie: 2 10.0 ← 8.9 ← 8.5 ↓ 10.6 * 9.4 ↖ 10.2 ↓ 6.5 ↖ 6.1 ↗ 8.9 ← 8.6 ↘

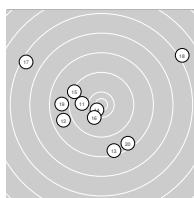
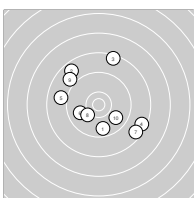

Ergebnis: **452** 148 Serien: 74 74
 179 89 90
 125 62 63
 Zähler: 6 17 13 9 6 7 Innenzehner: 2

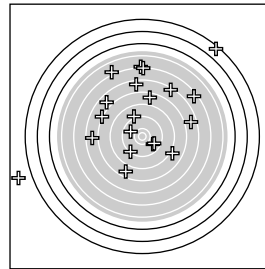
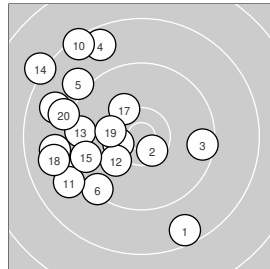
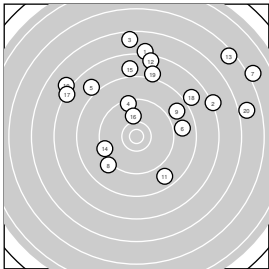

kniend Wertung

liegend Wertung

stehend Wertung

Serie: 1 7.2 ↑ 7.2 → 6.6 ↑ 9.5 ↑ 8.0 ↘ 8.9 → 5.1 ↗ 9.2 ↙ 8.8 ↗ 7.1 ↘
 Serie: 2 8.8 ↘ 7.5 ↑ 5.5 ↗ 9.4 ← 7.9 ↑ 10.0 ↑ 7.3 ↘ 8.0 ↗ 8.1 ↑ 5.9 →

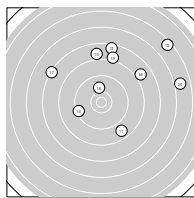
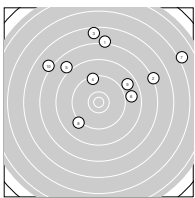

Serie: 1 8.6 ↘ 10.6 * 9.6 → 8.7 ↘ 9.1 ↘ 9.4 ↙ 10.4 * 9.1 ← 9.0 ← 8.4 ↘
 Serie: 2 9.0 ↙ 10.2 ↙ 9.6 ← 8.2 ↘ 9.6 ← 8.9 ↙ 10.2 ↘ 8.9 ← 10.2 ← 9.1 ←

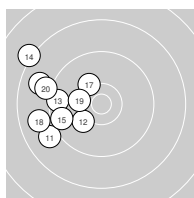
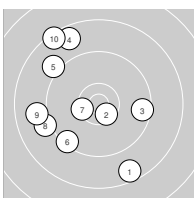

Serie: 1 5.6 ↗ 9.2 ↘ 6.6 ↑ 1.5 ↗ 9.9 ↙ 8.1 ↘ 7.8 ↙ 5.2 ↑ 7.2 ↘ 5.3 ↑
 Serie: 2 6.5 ↗ 5.1 ↘ 6.9 ↘ 6.8 ← 9.9 ↘ 9.8 ↘ 9.4 ↙ 7.7 ↑ 0.0 ← 6.8 →

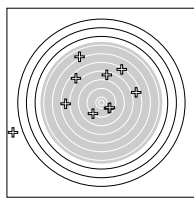
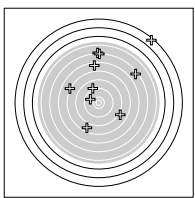

Ergebnis: **566** 186 Serien: 92 94
 198 99 99
 182 89 93
 Zähler: 34 19 6 1 0 0 Innenzehner: 26

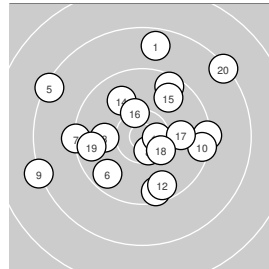
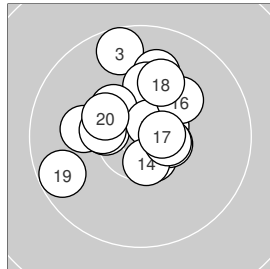
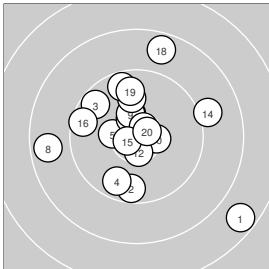

kniend Wertung

liegend Wertung

stehend Wertung

Serie: 1 7.7 ↘ 9.7 ↓ 9.7 ↖ 9.7 ↙ 10.4 * 10.4 * 10.5 * 8.7 ← 10.4 * 10.4 *
 Serie: 2 10.0 ↑ 10.6 * 10.7 * 9.1 → 10.7 * 9.6 ← 9.7 ↑ 8.7 ↑ 9.8 ↑ 10.7 *

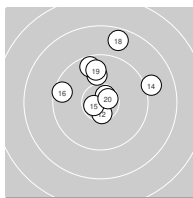
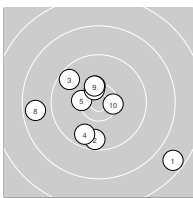

Serie: 1 10.6 * 10.4 * 9.6 ↑ 10.1 ← 10.6 * 10.6 * 10.4 * 10.5 * 10.0 ↑ 10.2 ↑
 Serie: 2 10.5 * 10.4 * 10.7 * 10.6 * 10.5 * 10.2 ↗ 10.6 * 10.1 ↑ 9.7 ← 10.3 *

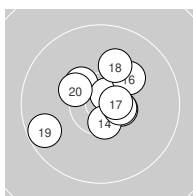
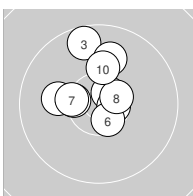

Serie: 1 8.7 ↑ 9.4 → 10.0 ← 9.6 ↓ 8.4 ↖ 9.7 ↙ 9.3 ← 10.6 * 8.3 ← 9.5 →
 Serie: 2 9.6 ↗ 9.7 ↓ 10.6 * 9.9 ↘ 9.8 ↗ 10.4 * 10.0 → 10.4 * 9.7 ← 8.4 ↗

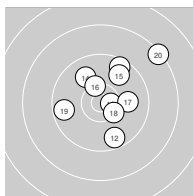
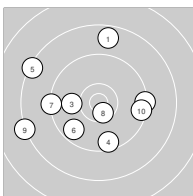

Ergebnis: **563** 184 Serien: 93 91
 189 96 93
 190 95 95
 Zähler: 28 27 5 0 0 0 Innenzehner: 20

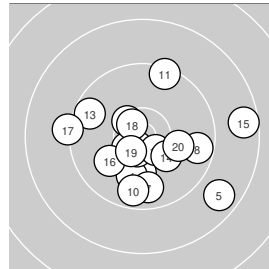
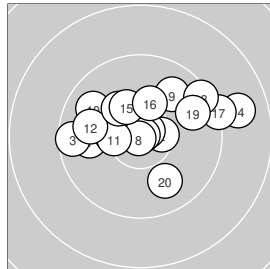
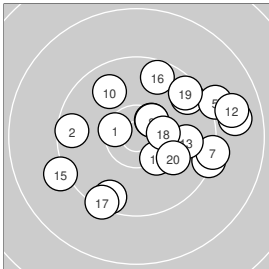

kniend Wertung

liegend Wertung

stehend Wertung

Serie: 1 10.5 * 9.6 ← 9.4 → 9.6 ↗ 9.2 ↗ 10.5 * 9.3 → 10.5 * 9.6 ↓ 9.9 ↘
 Serie: 2 8.9 → 8.9 → 9.9 → 10.3 * 9.2 ↙ 9.7 ↑ 9.4 ↓ 10.4 * 9.6 ↗ 10.1 →

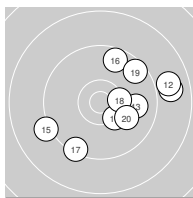
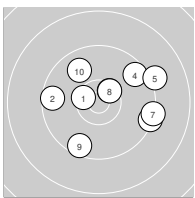

Serie: 1 9.9 ← 10.5 * 9.6 ← 10.4 * 10.8 * 10.4 * 10.9 * 10.9 * 9.9 ↗ 9.8 ↘
 Serie: 2 10.4 * 9.9 ← 10.2 ↘ 8.9 → 10.3 * 10.3 ↑ 9.3 → 9.5 → 9.8 → 9.9 ↓

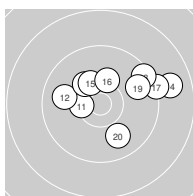
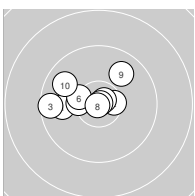

Serie: 1 10.5 * 10.5 * 10.1 ↓ 10.0 ↓ 8.8 ↘ 10.6 * 9.8 ↓ 9.7 → 10.7 * 9.7 ↓
 Serie: 2 9.4 ↑ 10.5 * 9.7 ↖ 10.2 ↘ 8.6 → 10.0 ↙ 9.3 ← 10.6 * 10.5 * 10.1 →

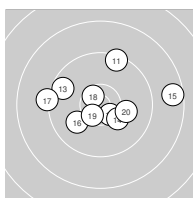
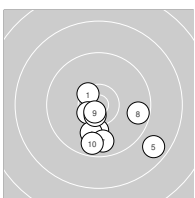

Ergebnis: **586** 195 Serien: 96 99
 198 99 99
 193 97 96
 Zähler: 47 12 1 0 0 0 Innenzehner: 30

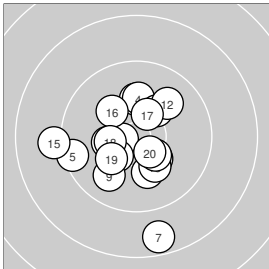

kniend Wertung

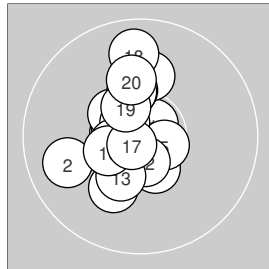

liegend Wertung

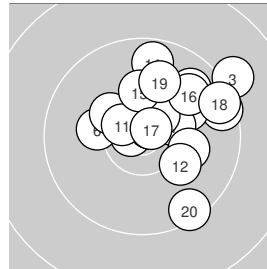

stehend Wertung

Serie: 1 10.1 ↑ 10.1 ↓ 10.6 * 10.1 ↑ 9.5 ← 10.3 * 8.7 ↓ 10.4 * 9.9 ↘ 10.3 *
 Serie: 2 10.2 ↗ 10.0 ↗ 10.2 ↓ 10.4 * 9.1 ← 10.2 ↘ 10.4 * 10.4 * 10.2 ↘ 10.5 *

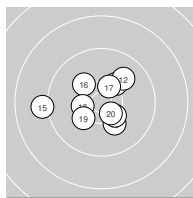
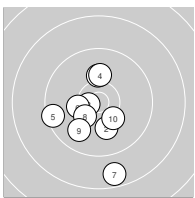

Serie: 1 10.7 * 9.9 ← 10.5 * 10.6 * 10.6 * 10.1 ↘ 10.6 * 10.1 ↑ 10.4 * 10.7 *
 Serie: 2 10.6 * 10.6 * 10.3 * 10.3 * 10.3 * 10.5 * 10.8 * 9.8 ↑ 10.5 * 10.1 ↑

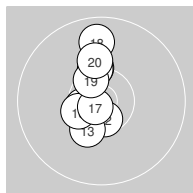
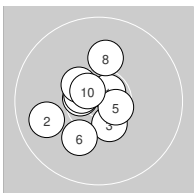

Serie: 1 9.5 → 10.8 * 9.1 ↗ 9.8 ↗ 10.1 ↗ 10.2 ← 10.4 * 10.1 → 10.3 * 10.8 *
 Serie: 2 10.6 * 10.2 ↓ 10.5 * 9.7 ↑ 10.2 ↑ 9.9 ↗ 10.8 * 9.5 → 10.0 ↑ 9.5 ↓

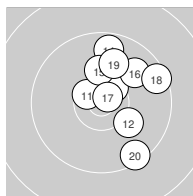
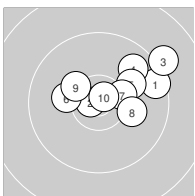

KK 3x20 – Wertung –

Junioren I weibl.

StartNr: 458

StandNr: 15

19. Juni 2022 13:50

Dziuballe, Ronja #267

3100 SGes Dalbke e.V.

Ergebnis: **483** 154 Serien: 76 78
 168 85 83
 161 77 84
 Zähler: 6 18 16 13 7 0 Innenzehner: 4

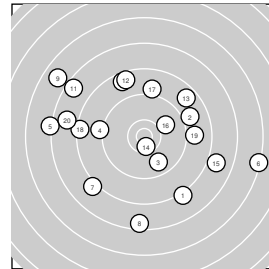
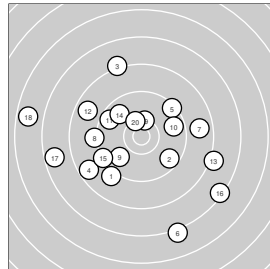
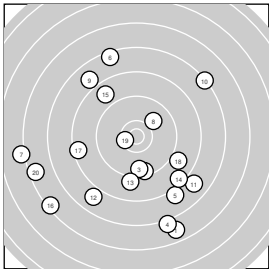

kniend Wertung

liegend Wertung

stehend Wertung

Serie: 1 6.8 ↘ 9.5 ↓ 9.6 ↓ 7.1 ↓ 8.1 ↓ 7.5 ↑ 6.2 ← 10.0 ↗ 7.9 ↘ 7.3 ↗
 Serie: 2 7.9 ↘ 7.9 ↗ 9.1 ↓ 8.5 ↘ 8.8 ↘ 6.4 ↗ 8.5 ← 9.0 ↘ 10.5 * 6.6 ←

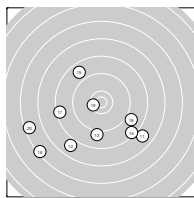
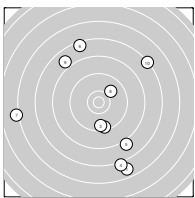

Serie: 1 9.1 ↗ 9.6 ↘ 8.2 ↑ 8.7 ↗ 9.4 ↗ 7.2 ↓ 8.8 → 9.2 ← 9.9 ↗ 9.7 →
 Serie: 2 9.6 ↗ 8.8 ↗ 8.1 → 9.8 ↘ 9.3 ↗ 7.4 ↘ 7.7 ← 6.7 ← 10.4 * 10.3 *

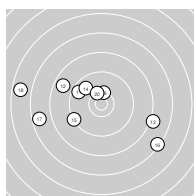
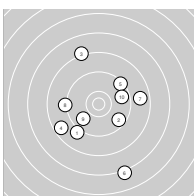

Serie: 1 8.2 ↘ 9.0 → 9.8 ↘ 9.2 ← 7.2 ← 6.4 → 8.1 ↗ 7.5 ↓ 6.9 ↘ 8.6 ↑
 Serie: 2 7.6 ↘ 8.6 ↑ 8.7 ↗ 10.6 * 8.0 → 10.0 → 9.1 ↑ 8.4 ← 9.0 → 7.9 ←

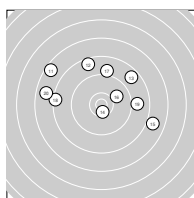
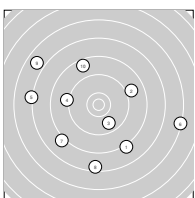

Ergebnis: **568** 185 Serien: 92 93
 197 98 99
 186 93 93
 Zähler: 33 23 3 1 0 0 Innenzehner: 15

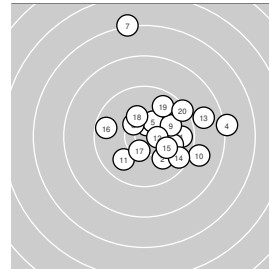
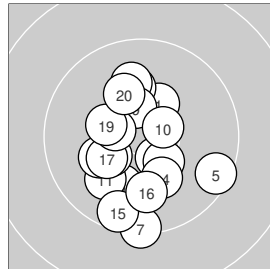
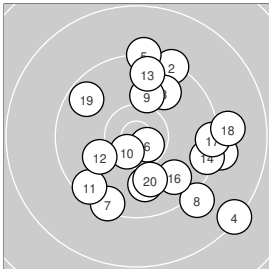

kniend Wertung

liegend Wertung

stehend Wertung

Serie: 1 9.2 → 9.4 ↗ 9.9 ↗ 8.4 ↘ 9.3 ↑ 10.7 * 9.5 ↓ 9.2 ↘ 10.1 ↑ 10.6 *
 Serie: 2 9.6 ↙ 10.1 ↖ 9.7 ↑ 9.5 → 10.0 ↓ 9.8 ↘ 9.4 → 9.1 → 9.7 ↘ 10.0 ↓

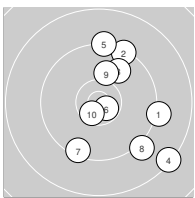

Serie: 1 10.3 * 10.1 ↑ 10.0 ↑ 10.5 * 9.5 ↘ 10.1 ↓ 9.4 ↓ 10.4 * 10.5 * 10.6 *
 Serie: 2 10.0 ↙ 10.2 ↖ 10.3 * 10.2 ↓ 9.6 ↓ 10.0 ↓ 10.3 ↖ 10.5 * 10.3 * 10.2 ↘

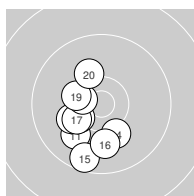
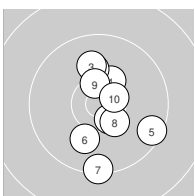

Serie: 1 9.7 → 10.0 ↘ 10.6 * 8.2 → 10.4 * 10.0 → 7.3 ↑ 10.4 * 10.0 → 9.0 →
 Serie: 2 9.9 ↙ 10.5 * 8.9 → 9.6 ↘ 10.1 ↘ 9.7 ← 10.5 * 10.2 ↑ 9.8 ↗ 9.4 ↗

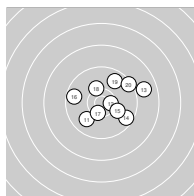
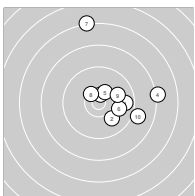

Ergebnis: **547** 184 Serien: 90 94
 193 97 96
 170 87 83
 Zähler: 24 24 9 1 2 0 Innenzehner: 14

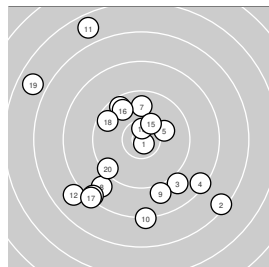
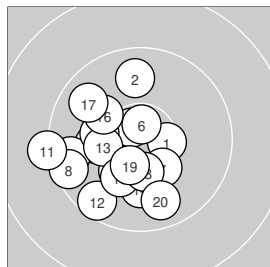
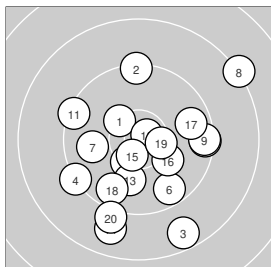

kniend Wertung

liegend Wertung

stehend Wertung

Serie: 1 10.4 * 9.4 ↑ 8.7 ↓ 9.3 ↙ 9.5 → 9.7 ↓ 9.9 ← 8.3 ↗ 9.5 → 10.7 *
 Serie: 2 9.4 ↖ 10.4 * 10.0 ↓ 8.9 ↓ 10.6 * 10.2 ↘ 9.7 → 9.7 ↓ 10.4 * 9.1 ↓

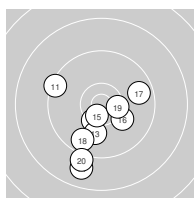
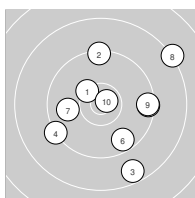

Serie: 1 10.5 * 9.8 ↑ 10.1 ← 9.7 ← 10.7 * 10.7 * 10.3 * 9.6 ← 10.3 ↗ 10.2 ←
 Serie: 2 9.3 ← 9.6 ↙ 10.3 ← 10.1 ↓ 10.2 ↙ 10.2 ↘ 9.8 ↖ 10.4 * 10.5 * 9.8 ↓

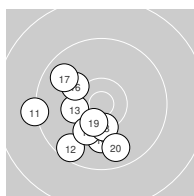
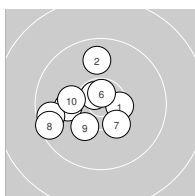

Serie: 1 10.8 * 7.5 ↘ 9.0 ↘ 8.5 ↘ 10.1 → 9.6 ↖ 9.8 ↑ 8.9 ↙ 9.0 ↓ 8.3 ↓
 Serie: 2 6.8 ↘ 8.0 ↙ 10.6 * 8.4 ↙ 10.3 * 9.8 ↖ 8.3 ↙ 9.6 ↖ 6.8 ↖ 9.4 ↙

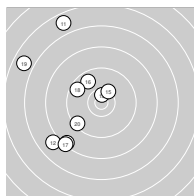
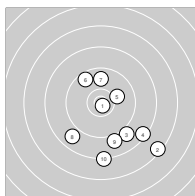

Ergebnis: **531** 183 Serien: 90 93
 184 93 91
 164 89 75
 Zähler: 20 26 9 1 3 0 Innenzehner: 12

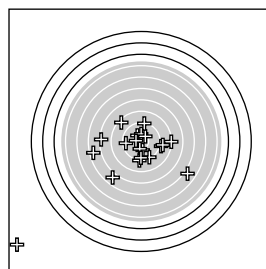
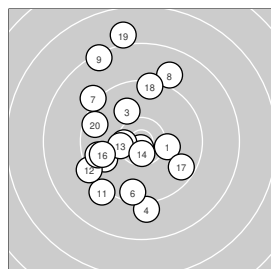
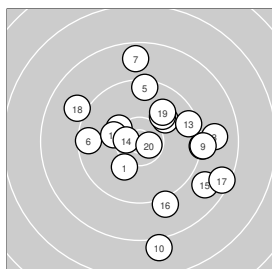

kniend Wertung

liegend Wertung

stehend Wertung

Serie: 1 10.2 ↘ 9.3 → 8.9 → 10.1 ↗ 9.5 ↑ 9.6 ← 8.7 ↑ 10.3 * 9.2 → 8.1 ↓
 Serie: 2 10.0 ↗ 10.2 ← 9.6 → 10.6 * 8.8 ↘ 9.1 ↓ 8.5 ↘ 9.1 ↖ 10.0 ↗ 10.7 *

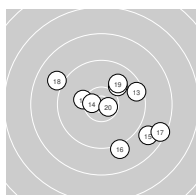
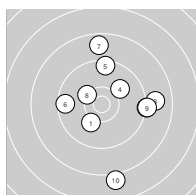

Serie: 1 10.2 → 10.8 * 10.0 ↖ 9.1 ↓ 9.9 ← 9.6 ↓ 9.2 ↖ 9.0 ↑ 8.4 ↖ 10.5 *
 Serie: 2 9.2 ↘ 9.3 ← 10.4 * 10.6 * 9.7 ← 9.8 ← 9.7 ↘ 9.4 ↑ 8.0 ↑ 9.6 ↖

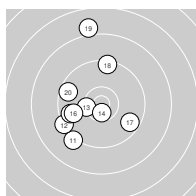
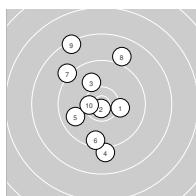

Serie: 1 10.2 ↓ 9.2 → 10.3 * 10.3 * 9.6 ← 10.3 * 9.3 ↓ 10.5 * 6.9 ↘ 6.0 ↘
 Serie: 2 8.5 ↖ 9.4 ↓ 9.0 → 8.3 → 0.0 ← 10.4 * 7.4 ← 6.6 ← 9.5 ↓ 9.4 ↑

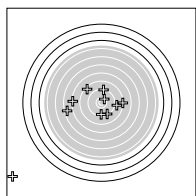
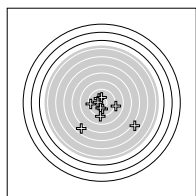

Ergebnis: **538** 178 Serien: 90 88
 190 95 95
 170 80 90
 Zähler: 19 26 11 2 2 0 Innenzehner: 10

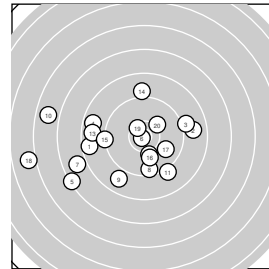
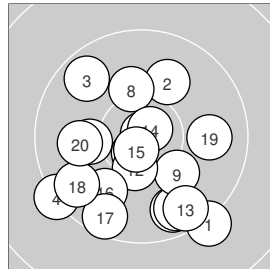
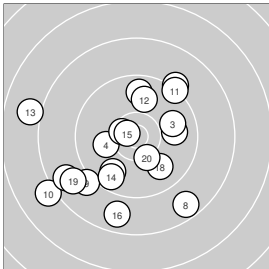

kniend Wertung

liegend Wertung

stehend Wertung

Serie: 1 9.2 ↗ 9.9 → 9.9 → 10.1 ← 10.5 * 9.8 ↙ 9.8 ↑ 8.7 ↘ 9.1 ↙ 8.1 ↙
 Serie: 2 9.3 ↗ 9.9 ↑ 8.0 ← 9.7 ↙ 10.7 * 8.8 ↓ 8.7 ↙ 9.9 ↘ 8.9 ↙ 10.3 *

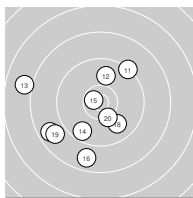
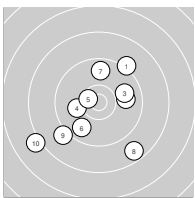

Serie: 1 9.2 ↘ 10.0 ↑ 9.7 ↘ 9.3 ↙ 10.9 * 9.7 ↘ 9.7 ↘ 10.2 ↑ 10.2 ↘ 10.1 ←
 Serie: 2 10.7 * 10.5 * 9.6 ↘ 10.8 * 10.7 * 9.9 ↙ 9.6 ↙ 9.7 ↙ 9.9 → 10.0 ←

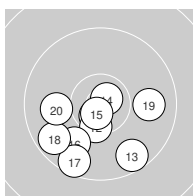
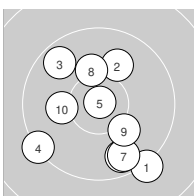

Serie: 1 8.6 ← 8.9 → 9.1 → 8.7 ← 7.4 ↙ 10.8 * 7.9 ↙ 9.6 ↓ 8.9 ↙ 6.8 ←
 Serie: 2 9.2 ↘ 10.2 ↓ 8.8 ← 9.1 ↑ 9.3 ← 10.0 ↓ 9.9 ↘ 6.0 ← 10.5 * 10.2 ↗

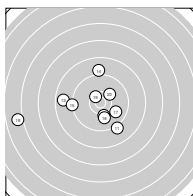
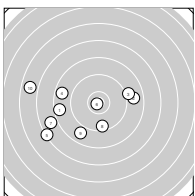

Ergebnis: **519** 185 Serien: 93 92
 188 93 95
 146 69 77
 Zähler: 18 24 8 3 4 2 Innenzehner: 10

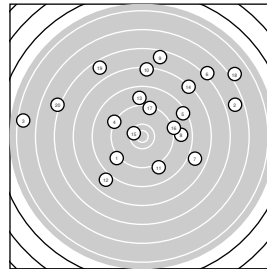
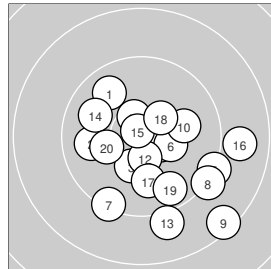
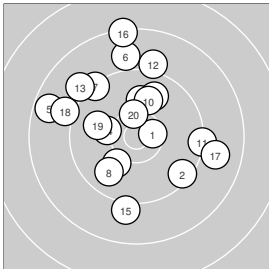

kniend Wertung

liegend Wertung

stehend Wertung

Serie: 1 10.5 * 9.5 ↘ 10.1 ↙ 10.0 ↑ 8.7 ↖ 9.0 ↑ 9.4 ↘ 9.8 ↙ 9.9 ↑ 10.0 ↑
 Serie: 2 9.3 → 9.1 ↑ 9.1 ↘ 10.2 ← 9.1 ↓ 8.4 ↑ 9.0 → 9.1 ↖ 10.0 ← 10.4 *

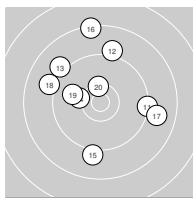
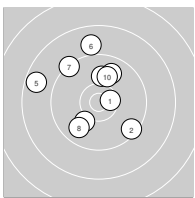

Serie: 1 9.8 ↘ 9.9 ← 10.3 * 10.5 * 9.3 → 10.3 * 9.4 ↙ 9.3 → 8.5 ↘ 10.0 →
 Serie: 2 10.5 * 10.5 * 9.1 ↓ 9.9 ↖ 10.8 * 8.9 → 10.0 ↓ 10.4 * 9.7 ↘ 10.2 ←

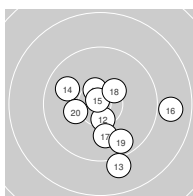
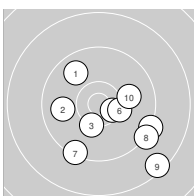

Serie: 1 9.2 ↙ 5.8 → 4.6 ← 9.3 ↖ 8.5 ↗ 6.2 ↗ 7.9 → 8.9 → 6.7 ↑ 7.4 ↑
 Serie: 2 9.1 ↘ 8.0 ↙ 8.9 ↑ 7.4 ↗ 10.5 * 9.2 → 9.4 ↑ 5.1 ↗ 6.7 ↘ 6.2 ←

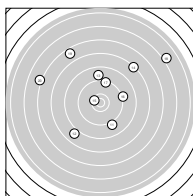
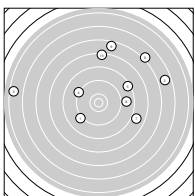

Ergebnis: **516** 177 Serien: 88 89
 193 98 95
 146 80 66
 Zähler: 20 21 8 3 5 2 Innenzehner: 8

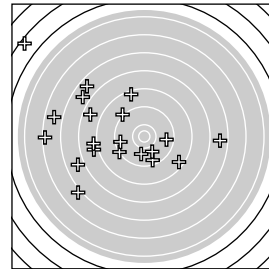
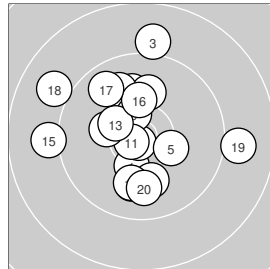
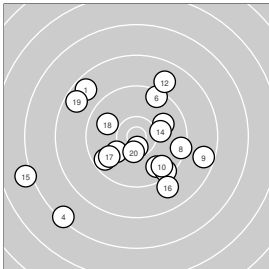

kniend Wertung

liegend Wertung

stehend Wertung

Serie: 1 8.7 ↘ 9.8 ↘ 10.0 ↗ 7.4 ↙ 10.6 * 9.5 ↗ 9.5 ↘ 9.4 → 8.7 → 9.7 ↘
 Serie: 2 10.1 ↙ 8.9 ↗ 9.7 ↙ 10.2 → 7.1 ← 9.0 ↘ 9.8 ↙ 9.9 ↖ 8.7 ↖ 10.4 *

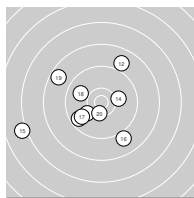
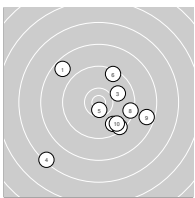

Serie: 1 10.3 * 10.1 ↓ 9.1 ↑ 10.8 * 10.3 * 10.0 ↑ 10.1 ↑ 9.9 ↘ 10.5 * 10.0 ↓
 Serie: 2 10.7 * 10.2 ← 10.4 * 10.0 ↓ 9.1 ← 10.2 ↑ 9.8 ↘ 9.0 ↖ 9.0 → 9.9 ↓

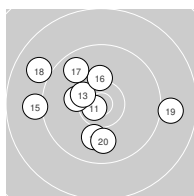
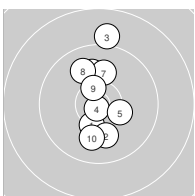

Serie: 1 5.4 ← 9.6 ↓ 9.7 → 5.8 ← 10.0 ↓ 9.3 ↙ 6.7 → 8.6 ↘ 10.0 ↓ 9.6 ←
 Serie: 2 7.7 ↖ 8.1 ← 6.7 ↖ 8.1 ← 9.2 ↘ 8.5 ↑ 6.9 ↖ 2.5 ↘ 6.9 ← 6.1 ↙

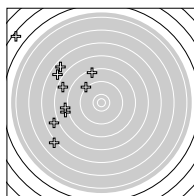
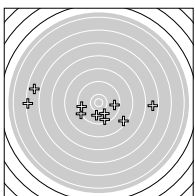

Ergebnis: **506** 164 Serien: 79 85
 186 91 95
 156 87 69
 Zähler: 14 23 12 5 2 2 Innenzehner: 9

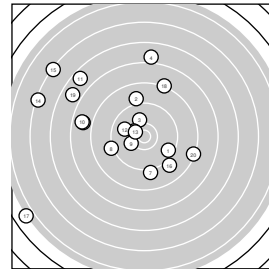
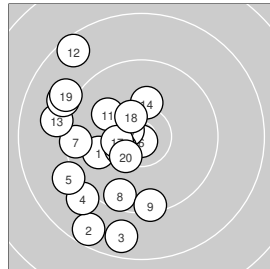
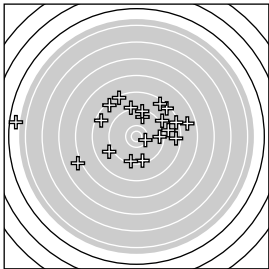

kniend Wertung

liegend Wertung

stehend Wertung

Serie: 1 8.4 ↖ 9.6 → 7.1 ↙ 10.4 * 9.7 ↑ 3.7 ← 9.2 ↑ 8.5 ↗ 7.8 → 9.2 ↗
 Serie: 2 8.6 ↘ 8.4 → 8.5 ↗ 9.4 ↑ 8.5 ↘ 8.6 → 9.0 → 9.5 ↓ 9.4 ↓ 9.1 ↙

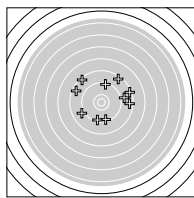
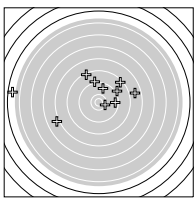

Serie: 1 10.0 ↙ 8.7 ↘ 8.8 ↓ 9.1 ↗ 9.1 ↙ 10.8 * 9.5 ← 9.6 ↓ 9.5 ↓ 10.6 *
 Serie: 2 10.1 ↘ 8.6 ↘ 9.1 ← 10.2 ↑ 9.1 ↙ 10.4 * 10.4 * 10.5 * 9.1 ↘ 10.4 *

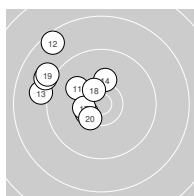
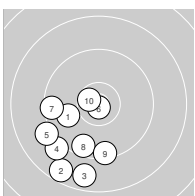

Serie: 1 9.6 ↘ 9.0 ↑ 10.1 ↑ 7.0 ↑ 7.9 ← 10.4 * 9.1 ↓ 9.2 ← 10.2 ← 7.8 ←
 Serie: 2 6.7 ↘ 9.9 ↙ 10.5 * 5.4 ← 5.4 ↘ 9.1 ↘ 3.9 ↗ 8.3 ↑ 6.9 ↘ 8.4 →

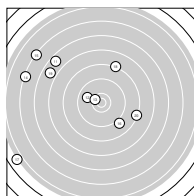
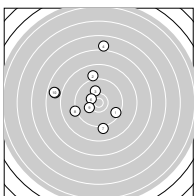

Ergebnis: **420** 129 Serien: 67 62

 154 82 72

 137 72 65

Zähler: 4 8 16 15 8 2 Innenzehner: 2

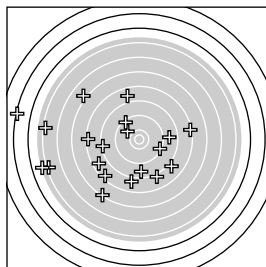
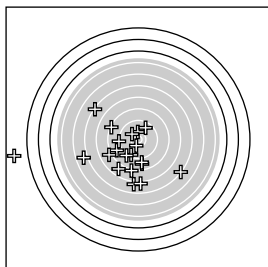
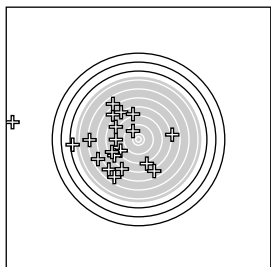

kniend Wertung

liegend Wertung

stehend Wertung

Serie: 1 8.6 ↙ 7.7 ↙ 5.5 ← 7.7 ↙ 9.8 ↘ 3.6 ← 7.0 ↘ 6.2 ↙ 7.3 ↘ 8.4 ←

Serie: 2 0.0 ← 6.0 ↙ 7.1 → 5.9 ↙ 8.0 ↘ 6.1 ↘ 8.0 ↑ 8.1 ↓ 7.0 ↓ 7.2 ↙

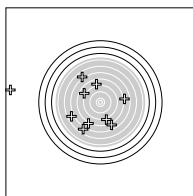
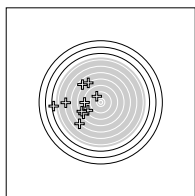

Serie: 1 6.4 ↘ 8.8 ↓ 10.4 * 10.3 * 7.1 ↓ 8.9 ↙ 9.3 ← 6.3 ↘ 9.8 ↑ 9.0 ↓

Serie: 2 7.1 ↓ 9.5 ↙ 6.0 ← 9.2 ↙ 10.2 ↘ 8.4 ↘ 8.2 ↓ 8.1 ↙ 0.0 ← 7.9 ↙

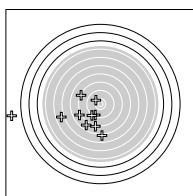
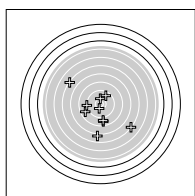

Serie: 1 7.5 ↙ 8.1 ↓ 6.4 ↙ 7.7 ↙ 7.4 ← 7.9 ↑ 8.9 → 4.4 ← 8.1 ↘ 10.0 ↘

Serie: 2 2.4 ← 7.4 → 8.7 ↓ 6.1 ↘ 4.4 ← 8.4 ← 9.4 ↘ 9.5 ↘ 8.0 ↓ 4.0 ←

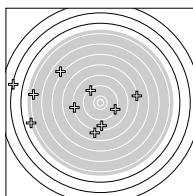
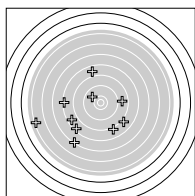

KK 3x20 – Wertung –

Jugend weibl.

StartNr: 446

StandNr: 10

19. Juni 2022 16:09

Sonneck, Emilia #135

1000 SFr Emsdetten e.V. / SFr Emsdetten e.V.

Ergebnis: **522** 170 Serien: 84 86
 182 93 89
 170 85 85
 Zähler: 14 23 16 5 2 0 Innenzehner: 9

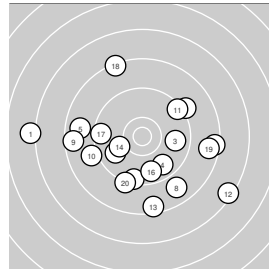
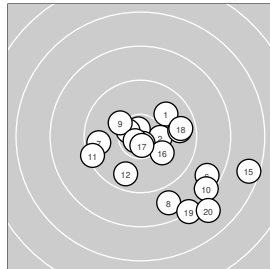
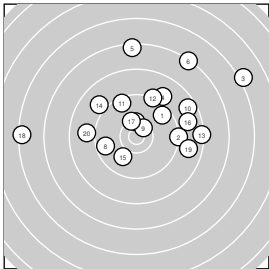

kniend Wertung

liegend Wertung

stehend Wertung

Serie: 1 9.6 ↗ 9.3 → 6.1 ↗ 9.1 ↗ 7.4 ↑ 7.3 ↗ 10.4 * 9.7 ← 10.5 * 8.6 ↗
 Serie: 2 9.5 ↘ 9.3 ↗ 8.4 → 9.0 ↘ 10.0 ↘ 8.8 → 10.3 * 6.4 ← 8.8 → 9.0 ←

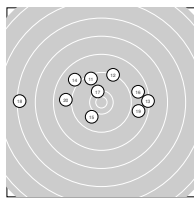
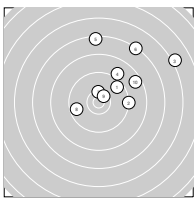

Serie: 1 10.0 ↗ 10.4 * 10.7 * 10.7 * 10.6 * 8.7 ↘ 9.7 ← 8.8 ↘ 10.2 ↘ 8.5 ↘
 Serie: 2 9.4 ← 9.8 ↘ 10.8 * 9.8 → 7.6 → 10.2 ↘ 10.7 * 9.7 → 8.3 ↘ 8.0 ↘

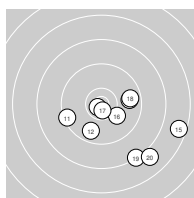
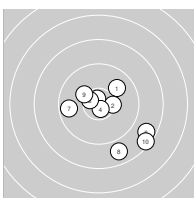

Serie: 1 7.1 ← 9.2 ↗ 9.8 → 9.8 ↘ 8.8 ← 9.5 ↓ 9.9 ← 8.9 ↘ 8.6 ← 9.1 ←
 Serie: 2 9.4 ↗ 7.4 ↘ 8.5 ↓ 10.1 ← 8.5 → 9.7 ↓ 9.5 ← 8.4 ↘ 8.6 → 9.3 ↓

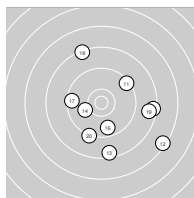
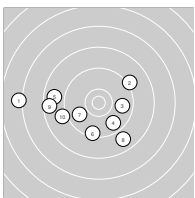

Ergebnis: **564** 189 Serien: 95 94
 192 95 97
 183 89 94
 Zähler: 27 30 3 0 0 0 Innenzehner: 13

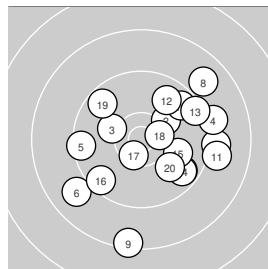
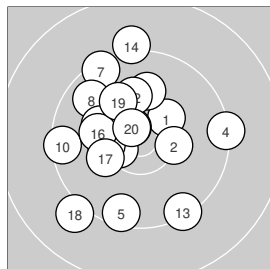
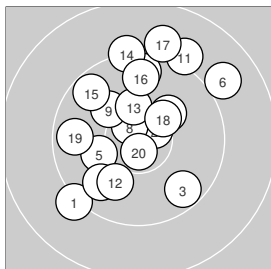

kniend Wertung

liegend Wertung

stehend Wertung

Serie: 1 9.2 ↘ 10.6 * 9.7 ↘ 10.2 ↗ 10.1 ← 9.0 ↗ 9.9 ↘ 10.6 * 10.1 ↘ 9.6 ↑
 Serie: 2 9.1 ↗ 10.0 ↘ 10.3 * 9.3 ↑ 9.7 ↘ 9.8 ↑ 9.1 ↑ 10.3 * 9.7 ← 10.7 *

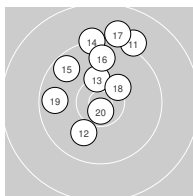
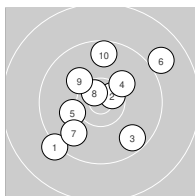

Serie: 1 10.3 * 10.3 * 10.7 * 9.4 → 9.5 ↓ 10.0 ↑ 9.5 ↘ 9.8 ↘ 10.5 * 9.5 ←
 Serie: 2 10.2 ↘ 10.1 ↑ 9.4 ↘ 9.2 ↑ 10.3 * 10.1 ← 10.2 ↘ 9.1 ↘ 10.1 ↘ 10.7 *

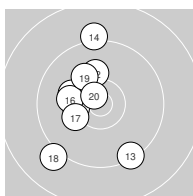
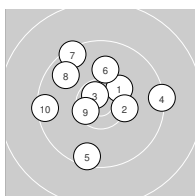

Serie: 1 9.1 → 10.2 ↗ 10.2 ↘ 9.2 → 9.5 ← 8.9 ↘ 9.7 ↘ 8.9 ↗ 8.4 ↓ 9.7 ↗
 Serie: 2 9.1 → 9.8 ↗ 9.5 ↗ 9.7 ↘ 10.0 → 9.6 ↘ 10.5 * 10.5 * 9.7 ↘ 10.0 ↘

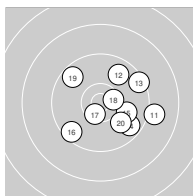
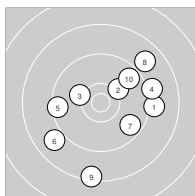

Ergebnis: **545** 180 Serien: 89 91
 190 95 95
 175 91 84
 Zähler: 20 29 8 2 1 0 Innenzehner: 11

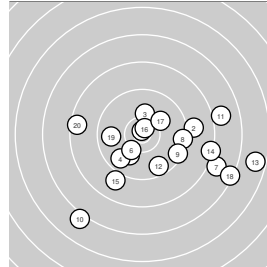
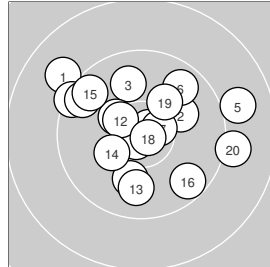
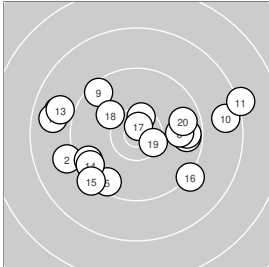

kniend Wertung

liegend Wertung

stehend Wertung

Serie: 1 9.7→ 9.1← 9.7→ 8.9↖ 9.6↙ 9.6↖ 10.5* 9.9→ 9.5↘ 8.7→
 Serie: 2 8.2→ 8.8← 9.0↖ 9.6↖ 9.3↙ 9.2↘ 10.7* 10.1↘ 10.5* 9.7→

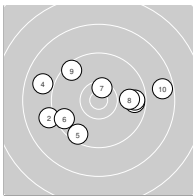

Serie: 1 9.0↘ 10.1↗ 9.9↑ 9.4↖ 9.0→ 9.8↗ 10.8* 10.3* 10.8* 10.1↓
 Serie: 2 9.6↖ 10.5* 9.9↓ 10.3↖ 9.7↖ 9.7↘ 10.6* 10.8* 10.2↗ 9.1→

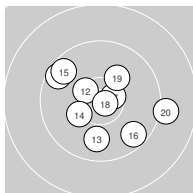
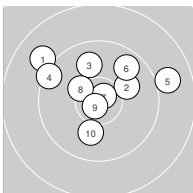

Serie: 1 10.1↙ 9.1→ 10.2↑ 9.8↙ 10.8* 10.3↙ 8.0→ 9.5→ 9.5↘ 7.1↙
 Serie: 2 8.0→ 9.7↘ 6.7→ 8.4→ 9.0↙ 10.7* 10.1↗ 7.4↘ 9.8← 8.5←

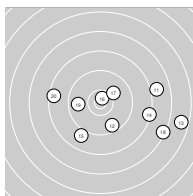
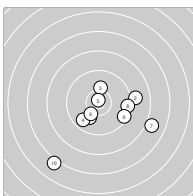

Ergebnis: **539** 181 Serien: 94 87
 185 93 92
 173 85 88
 Zähler: 17 29 11 2 1 0 Innenzehner: 9

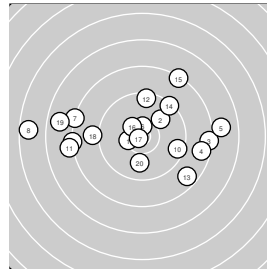
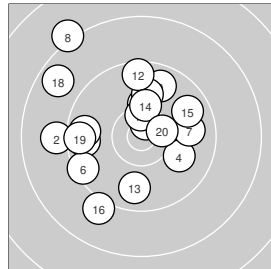
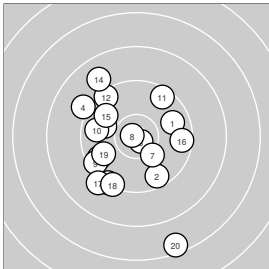

kniend Wertung

liegend Wertung

stehend Wertung

Serie: 1 9.8 → 9.6 ↓ 10.0 ↖ 9.2 ↘ 9.7 ← 10.8 * 10.2 ↘ 10.8 * 9.5 ↙ 9.8 ←
 Serie: 2 9.6 ↗ 9.5 ↖ 9.3 ↘ 8.9 ↖ 9.9 ↖ 9.6 → 9.2 ↗ 9.4 ↓ 9.9 ← 7.5 ↓

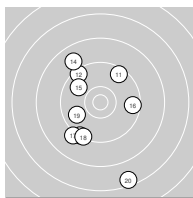
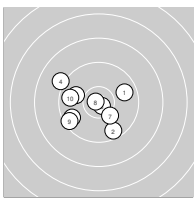

Serie: 1 9.7 ← 9.1 ← 10.7 * 10.0 ↘ 10.2 ↑ 9.5 ↙ 9.9 → 8.2 ↘ 9.8 ↑ 10.5 *
 Serie: 2 10.0 ↑ 9.6 ↑ 9.8 ↓ 10.3 ↑ 9.8 ↗ 9.1 ↓ 9.7 ← 8.7 ↘ 9.6 ← 10.5 *

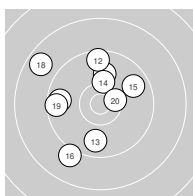
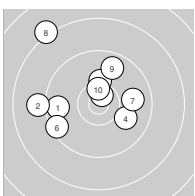

Serie: 1 10.4 * 10.0 ↗ 8.4 → 8.7 → 8.0 → 10.6 * 8.3 ← 6.6 ← 8.3 ← 9.5 →
 Serie: 2 8.2 ← 9.5 ↑ 8.7 ↘ 9.4 ↗ 8.4 ↑ 10.4 * 10.8 * 9.1 ← 7.8 ← 10.0 ↓

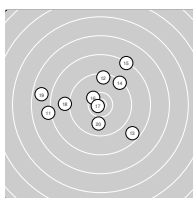
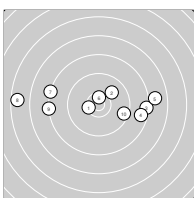

Ergebnis: **198.0** (191)
 Serien: 98.7 99.3
 Zähler: 11 9 0 0 0 0 0 0 0 0
 Innenzehner: 8
 Weitestе: 491 (4.), 476 (19.), 444 (20.)
 beste Teiler: 46.0 (11.), 115.2 (18.), 128.7 (14.)
 Trefferlage: 0.24 mm links, 0.45 mm tief
 Streuwert: 2.10, horizontal: 2.06, vertikal: 2.13

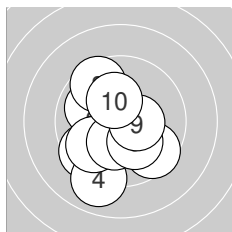
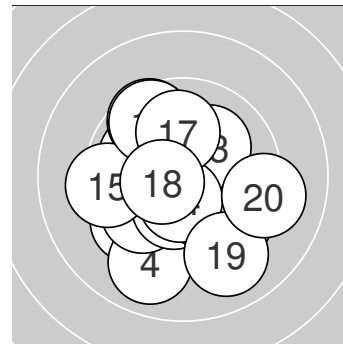

Serie 1:
 9.5 ↙ 10.0 ↘ 9.6 ↘ 9.0 ↓ 9.6 ↘
 9.8 ↙ 10.3 * 10.2 * 10.4 * 10.3 *
 beste Teiler: 130.5 (9.), 173.0 (7.), 174.3 (10.)
 Trefferlage: 0.66 mm links, 0.89 mm tief
 Streuwert: 2.04, horizontal: 1.79, vertikal: 2.26

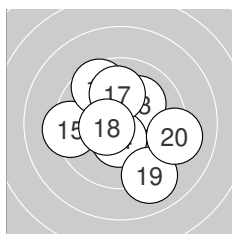

Serie 2:
 10.8 * 10.4 * 10.1 ↗ 10.4 * 9.3 ←
 9.6 ↘ 10.0 ↑ 10.5 * 9.0 ↘ 9.2 →
 beste Teiler: 46.0 (11.), 115.2 (18.), 128.7 (14.)
 Trefferlage: 0.18 mm rechts, 0.01 mm tief
 Streuwert: 2.17, horizontal: 2.31, vertikal: 2.02



Ergebnis: **186.5** (179)
 Serien: 95.4 91.1
 Zähler: 6 8 5 1 0 0 0 0 0 0
 Innenzehner: 4
 Weitestе: 776 (16.), 672 (3.), 634 (20.)
 beste Teiler: 130.2 (9.), 136.8 (18.), 167.1 (7.)
 Trefferlage: 0.24 mm links, 0.45 mm hoch
 Streuwert: 3.21, horizontal: 3.80, vertikal: 2.48

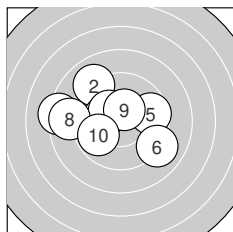
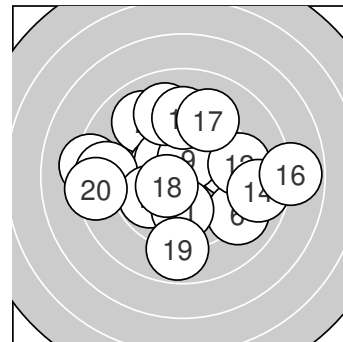

Serie 1:
 10.1 ↘ 9.0 ↘ 8.3 ← 10.2 * 9.6 →
 9.0 ↘ 10.3 * 8.7 ← 10.4 * 9.8 ↙
 beste Teiler: 130.2 (9.), 167.1 (7.), 179.3 (4.)
 Trefferlage: 1.47 mm links, 0.56 mm hoch
 Streuwert: 2.68, horizontal: 3.36, vertikal: 1.74

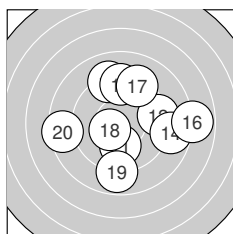

Serie 2:
 10.0 ↓ 9.3 → 9.1 ↑ 8.7 → 9.3 ↑
 7.8 → 9.2 ↗ 10.4 * 8.9 ↓ 8.4 ←
 beste Teiler: 136.8 (18.), 241.0 (11.), 414.0 (12.)
 Trefferlage: 0.98 mm rechts, 0.33 mm hoch
 Streuwert: 3.59, horizontal: 3.98, vertikal: 3.15



Ergebnis: **143.2** (136)
Serien: 75.1 68.1
Zähler: 2 1 7 3 3 1 1 1 0 0
Innenzehner: 1
Weiteste: 2670 (12.), 1945 (15.), 1607 (17.)
beste Teiler: 79.7 (16.), 246.5 (20.), 495.4 (7.)
Trefferlage: 2.12 mm links, 2.23 mm hoch
Streuwert: 7.75, horizontal: 8.41, vertikal: 7.03

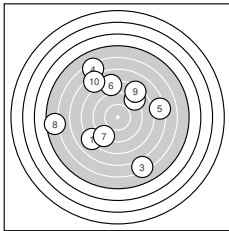
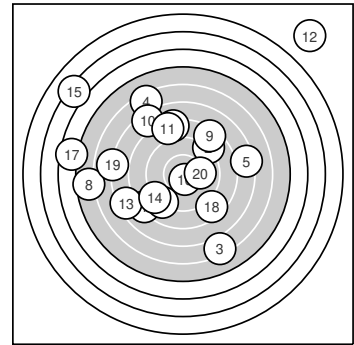

Serie 1:

8.1 ↙	8.9 ↗	6.2 ↘	6.3 ↖	7.3 →
8.1 ↑	9.0 ↙	5.6 ←	8.3 ↗	7.3 ↖

beste Teiler: 495.4 (7.), 524.7 (2.), 664.3 (9.)
Trefferlage: 1.16 mm links, 1.52 mm hoch
Streuwert: 6.60, horizontal: 6.63, vertikal: 6.57

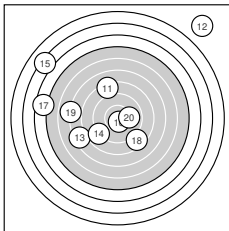

Serie 2:

8.2 ↖	0.0 ↗	7.3 ↙	8.9 ↘	3.2 ↖
10.6 *	4.5 ←	8.5 ↘	6.9 ←	10.0 →

beste Teiler: 79.7 (16.), 246.5 (20.), 519.8 (14.)
Trefferlage: 3.07 mm links, 2.94 mm hoch
Streuwert: 9.04, horizontal: 10.17, vertikal: 7.75



Ergebnis: **179.5** (171)
Serien: 88.1 91.4
Zähler: 3 7 8 2 0 0 0 0 0 0
Innenzehner: 1
Weiteste: 920 (6.), 903 (4.), 658 (16.)
beste Teiler: 123.7 (14.), 212.2 (10.), 233.3 (12.)
Trefferlage: 0.37 mm links, 1.09 mm hoch
Streuwert: 3.79, horizontal: 4.70, vertikal: 2.57

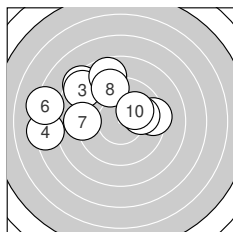
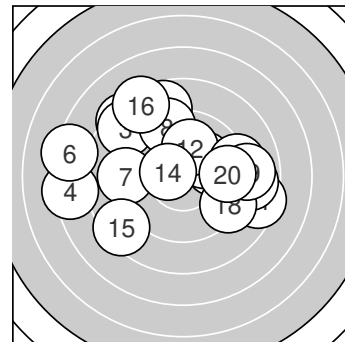

Serie 1:
 8.4 ↖ 9.4 → 8.6 ↘ 7.3 ← 8.7 ↑
 7.3 ← 9.1 ← 9.3 ↑ 9.9 → 10.1 ↗
beste Teiler: 212.2 (10.), 252.3 (9.), 391.8 (2.)
Trefferlage: 2.64 mm links, 2.06 mm hoch
Streuwert: 3.53, horizontal: 4.50, vertikal: 2.17

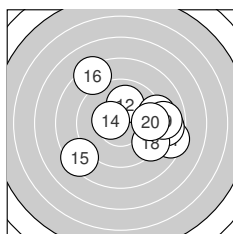

Serie 2:
 8.5 → 10.0 ↑ 9.2 → 10.5 * 8.4 ↙
 8.3 ↘ 8.8 → 9.3 ↘ 8.9 → 9.5 →
beste Teiler: 123.7 (14.), 233.3 (12.), 354.4 (20.)
Trefferlage: 1.89 mm rechts, 0.12 mm hoch
Streuwert: 3.32, horizontal: 3.87, vertikal: 2.67



Ergebnis: **182.0** (173)
 Serien: 90.0 92.0
 Zähler: 6 5 6 2 1 0 0 0 0 0
 Innenzehner: 4
 Weitester: 1016 (6.), 971 (8.), 772 (1.)
 beste Teiler: 142.5 (10.), 160.9 (16.), 172.5 (9.)
 Trefferlage: 1.58 mm links, 2.31 mm hoch
 Streuwert: 3.28, horizontal: 3.49, vertikal: 3.07

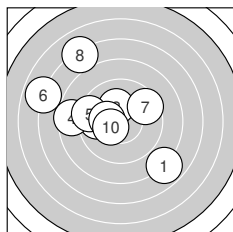
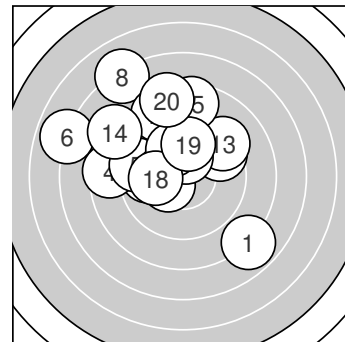

Serie 1:
 7.9 ↘ 10.2 * 9.8 ← 8.5 ← 9.4 ←
 6.9 ↖ 9.5 ↗ 7.1 ↖ 10.3 * 10.4 *
 beste Teiler: 142.5 (10.), 172.5 (9.), 188.8 (2.)
 Trefferlage: 2.25 mm links, 1.06 mm hoch
 Streuwert: 3.93, horizontal: 4.37, vertikal: 3.44

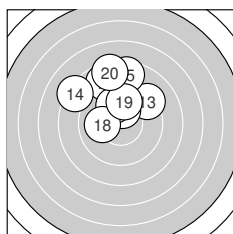

Serie 2:
 8.7 ↑ 8.7 ↖ 9.2 ↗ 8.3 ↖ 8.5 ↑
 10.3 * 10.0 ↖ 10.0 ← 9.9 ↑ 8.4 ↑
 beste Teiler: 160.9 (16.), 227.6 (18.), 235.4 (17.)
 Trefferlage: 0.90 mm links, 3.55 mm hoch
 Streuwert: 2.25, horizontal: 2.36, vertikal: 2.13



Ergebnis: **172.7** (165)
 Serien: 86.7 86.0
 Zähler: 3 9 3 2 2 0 1 0 0 0
 Innenzehner: 1
 Weitester: 1681 (16.), 1118 (14.), 1066 (1.)
 beste Teiler: 199.7 (12.), 203.6 (20.), 222.1 (7.)
 Trefferlage: 3.12 mm rechts, 1.20 mm tief
 Streuwert: 4.42, horizontal: 4.72, vertikal: 4.11

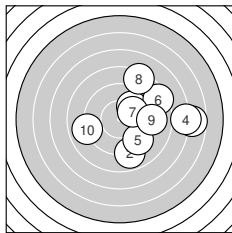
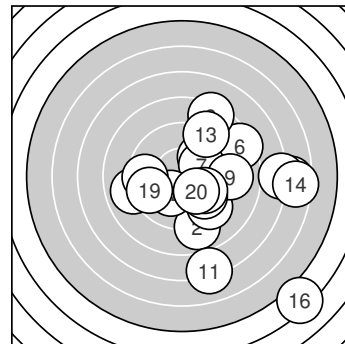

Serie 1:

6.7 →	8.9 ↓	9.9 ↗	7.0 →	9.3 ↘
8.4 ↗	10.1 ↗	8.3 ↗	9.1 →	9.0 ←

beste Teiler: 222.1 (7.), 261.7 (3.), 403.4 (5.)
 Trefferlage: 3.68 mm rechts, 0.21 mm hoch
 Streuwert: 3.80, horizontal: 4.41, vertikal: 3.06

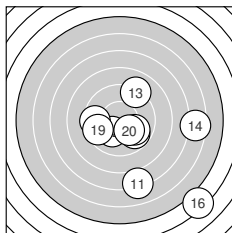

Serie 2:

7.1 ↓	10.2 *	9.1 ↗	6.5 →	9.8 ↘
4.2 ↘	9.9 ↘	9.5 ←	9.6 ←	10.1 ↘

beste Teiler: 199.7 (12.), 203.6 (20.), 262.9 (17.)
 Trefferlage: 2.57 mm rechts, 2.61 mm tief
 Streuwert: 4.93, horizontal: 5.18, vertikal: 4.68



Ergebnis: **179.2** (172)
 Serien: 91.0 88.2
 Zähler: 3 8 8 0 1 0 0 0 0 0
 Innenzehner: 3
 Weitester: 1102 (5.), 725 (11.), 678 (13.)
 beste Teiler: 168.1 (8.), 172.2 (2.), 200.2 (10.)
 Trefferlage: 0.19 mm links, 0.22 mm tief
 Streuwert: 3.92, horizontal: 4.73, vertikal: 2.90

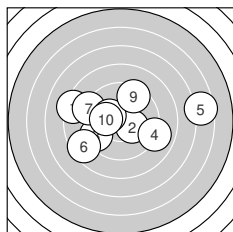
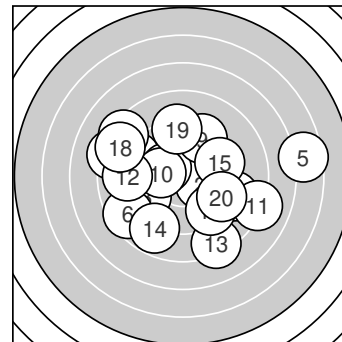

Serie 1:
 8.3 ← 10.3 * 9.4 ↙ 9.0 → 6.5 →
 8.5 ↙ 9.1 ← 10.3 * 9.4 ↗ 10.2 *
 beste Teiler: 168.1 (8.), 172.2 (2.), 200.2 (10.)
 Trefferlage: 0.37 mm links, 0.21 mm hoch
 Streuwert: 3.99, horizontal: 5.23, vertikal: 2.11

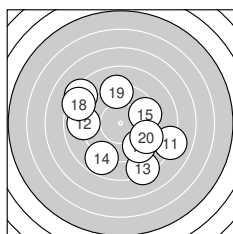

Serie 2:
 8.1 → 8.9 ← 8.2 ↓ 8.8 ↘ 9.5 →
 9.4 ↘ 8.3 ↖ 8.4 ↖ 9.2 ↑ 9.4 ↘
 beste Teiler: 354.9 (15.), 396.3 (20.), 397.4 (16.)
 Trefferlage: 0.01 mm links, 0.65 mm tief
 Streuwert: 4.04, horizontal: 4.44, vertikal: 3.58



Ergebnis: **165.0** (156)
 Serien: 80.1 84.9
 Zähler: 5 2 4 4 4 0 1 0 0 0
 Innenzehner: 4
 Weitester: 1588 (5.), 1230 (16.), 1173 (3.)
 beste Teiler: 40.2 (18.), 47.0 (8.), 153.3 (10.)
 Trefferlage: 3.48 mm links, 1.05 mm tief
 Streuwert: 5.16, horizontal: 6.90, vertikal: 2.36

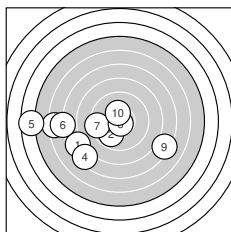
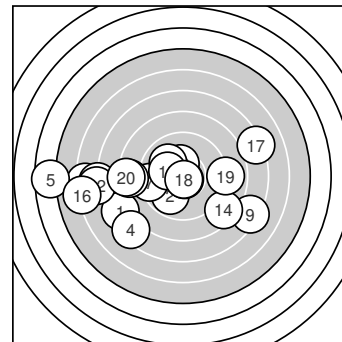

Serie 1:

7.5 ↙	9.8 ↙	6.3 ←	7.4 ↙	4.6 ←
6.9 ←	9.3 ←	10.8 *	7.2 ↘	10.3 *

beste Teiler: 47.0 (8.), 153.3 (10.), 276.5 (2.)
 Trefferlage: 4.91 mm links, 1.88 mm tief
 Streuwert: 5.19, horizontal: 6.92, vertikal: 2.43

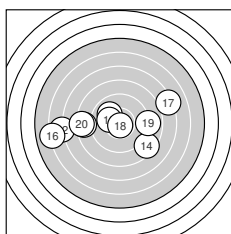

Serie 2:

10.0 ↘	6.8 ←	10.2 *	8.4 ↘	8.4 ←
6.0 ←	7.2 →	10.8 *	8.9 →	8.2 ←

beste Teiler: 40.2 (18.), 194.1 (13.), 239.4 (11.)
 Trefferlage: 2.04 mm links, 0.23 mm tief
 Streuwert: 5.12, horizontal: 6.93, vertikal: 2.09



Ergebnis: **168.0** (160)
 Serien: 87.4 80.6
 Zähler: 4 2 7 5 1 1 0 0 0 0
 Innenzehner: 3
 Weitester: 1409 (20.), 1187 (7.), 989 (16.)
 beste Teiler: 38.2 (4.), 89.4 (6.), 160.0 (18.)
 Trefferlage: 0.54 mm rechts, 2.12 mm tief
 Streuwert: 5.05, horizontal: 6.40, vertikal: 3.16

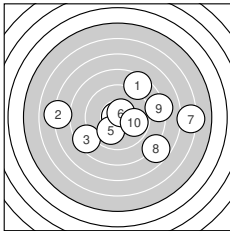
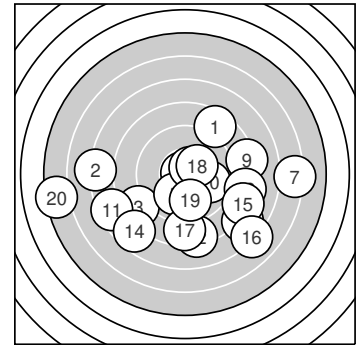

Serie 1:

8.5 ↗	7.1 ←	8.5 ↙	10.8 *	10.0 ↙
10.6 *	6.2 →	7.7 ↘	8.2 →	9.8 →

beste Teiler: 38.2 (4.), 89.4 (6.), 240.6 (5.)
 Trefferlage: 1.50 mm rechts, 0.38 mm tief
 Streuwert: 4.78, horizontal: 6.15, vertikal: 2.82

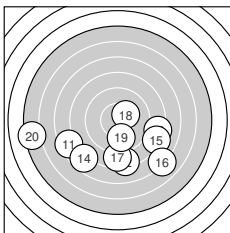

Serie 2:

7.4 ↙	8.2 ↓	8.3 →	7.7 ↙	8.1 ↘
7.0 ↘	8.5 ↓	10.3 *	9.8 ↓	5.3 ←

beste Teiler: 160.0 (18.), 286.9 (19.), 601.0 (17.)
 Trefferlage: 0.41 mm links, 3.87 mm tief
 Streuwert: 5.16, horizontal: 6.84, vertikal: 2.54



Ergebnis: **195.0** (188)
Serien: 96.3 98.7
Zähler: 11 6 3 0 0 0 0 0 0 0
Innenzehner: 8
Weiteste: 641 (7.), 630 (2.), 581 (15.)
beste Teiler: 81.3 (5.), 98.0 (1.), 117.8 (16.)
Trefferlage: 0.91 mm links, 0.16 mm hoch
Streuwert: 2.43, horizontal: 2.48, vertikal: 2.38

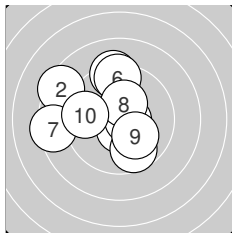
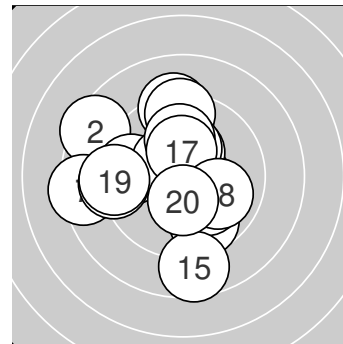

Serie 1:

10.6 *	8.4 ↘	9.2 ↑	9.7 ↓	10.6 *
9.4 ↑	8.4 ←	10.3 *	10.1 ↘	9.6 ←

beste Teiler: 81.3 (5.), 98.0 (1.), 155.7 (8.)
Trefferlage: 1.19 mm links, 0.67 mm hoch
Streuwert: 2.65, horizontal: 2.86, vertikal: 2.43

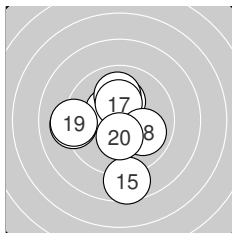

Serie 2:

9.2 ←	10.2 *	10.4 *	10.0 ↑	8.6 ↓
10.5 *	10.3 *	10.0 ↘	9.2 ←	10.3 *

beste Teiler: 117.8 (16.), 135.5 (13.), 154.0 (20.)
Trefferlage: 0.63 mm links, 0.35 mm tief
Streuwert: 2.25, horizontal: 2.16, vertikal: 2.33



Ergebnis: **189.6** (181)
Serien: 94.8 94.8
Zähler: 9 6 3 1 1 0 0 0 0 0
Innenzehner: 6
Weiteste: 1005 (18.), 914 (10.), 697 (14.)
beste Teiler: 57.3 (6.), 58.0 (16.), 76.8 (20.)
Trefferlage: 1.17 mm rechts, 0.34 mm hoch
Streuwert: 3.19, horizontal: 3.69, vertikal: 2.60

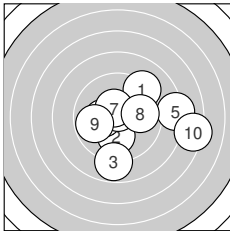
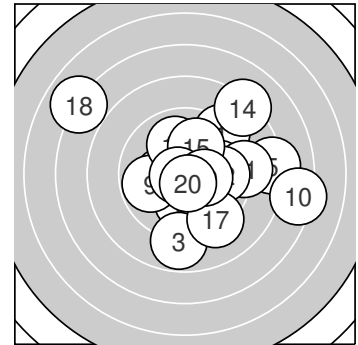

Serie 1:
 9.2 ↗ 10.1 ↓ 8.8 ↓ 10.3 * 8.2 →
 10.7 * 10.5 * 9.9 → 9.8 ← 7.3 →
beste Teiler: 57.3 (6.), 117.1 (7.), 174.4 (4.)
Trefferlage: 1.59 mm rechts, 0.40 mm tief
Streuwert: 3.13, horizontal: 3.79, vertikal: 2.30

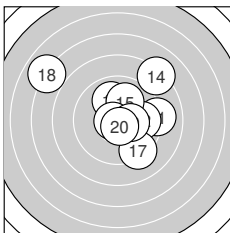

Serie 2:
 9.1 → 9.8 → 10.0 ↖ 8.2 ↗ 10.0 ↗
 10.7 * 9.2 ↘ 6.9 ↖ 10.3 * 10.6 *
beste Teiler: 58.0 (16.), 76.8 (20.), 155.5 (19.)
Trefferlage: 0.74 mm rechts, 1.09 mm hoch
Streuwert: 3.30, horizontal: 3.75, vertikal: 2.78



Ergebnis: **188.3** (180)
 Serien: 95.6 92.7
 Zähler: 8 7 4 0 0 1 0 0 0 0
 Innenzehner: 5
 Weitestе: 1292 (15.), 657 (13.), 581 (3.)
 beste Teiler: 116.2 (18.), 132.3 (2.), 161.0 (12.)
 Trefferlage: 1.31 mm links, 0.60 mm hoch
 Streuwert: 3.20, horizontal: 3.62, vertikal: 2.72

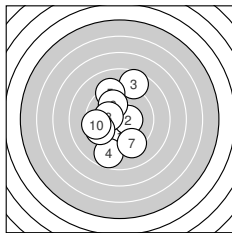
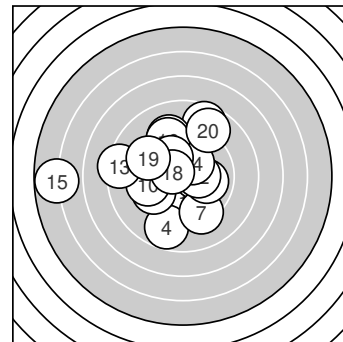

Serie 1:
 9.9 ↓ 10.4 * 8.6 ↑ 8.8 ↓ 9.2 ↑
 10.0 ↖ 9.3 ↘ 10.3 * 9.6 ↙ 9.5 ←
 beste Teiler: 132.3 (2.), 175.1 (8.), 247.0 (6.)
 Trefferlage: 0.69 mm links, 0.19 mm tief
 Streuwert: 2.75, horizontal: 1.99, vertikal: 3.35

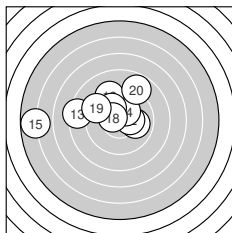

Serie 2:
 10.0 → 10.3 * 8.3 ← 10.3 * 5.8 ←
 9.3 ↖ 10.1 ↘ 10.5 * 9.3 ↙ 8.8 ↑
 beste Teiler: 116.2 (18.), 161.0 (12.), 167.2 (14.)
 Trefferlage: 1.92 mm links, 1.39 mm hoch
 Streuwert: 3.60, horizontal: 4.78, vertikal: 1.73



Ergebnis: **142.4** (131)
 Serien: 78.8 63.6
 Zähler: 0 2 6 4 2 3 2 0 1 0
 Innenzehner: 0
 Weitester: 2122 (18.), 1679 (13.), 1520 (19.)
 beste Teiler: 252.4 (14.), 279.2 (9.), 539.4 (4.)
 Trefferlage: 2.14 mm links, 0.97 mm tief
 Streuwert: 7.58, horizontal: 8.09, vertikal: 7.02

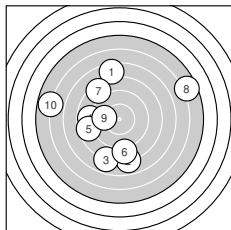
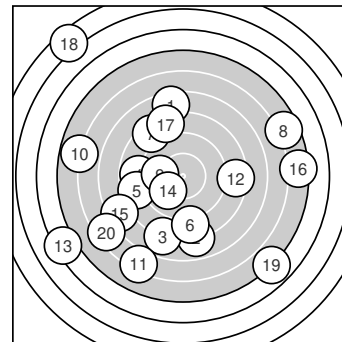

Serie 1:

7.4 ↑	7.9 ↓	7.9 ↓	8.8 ←	8.6 ←
8.6 ↓	8.4 ↖	5.6 ↗	9.8 ←	5.8 ←

beste Teiler: 279.2 (9.), 539.4 (4.), 587.4 (5.)
 Trefferlage: 1.94 mm links, 0.02 mm hoch
 Streuwert: 6.00, horizontal: 6.35, vertikal: 5.63

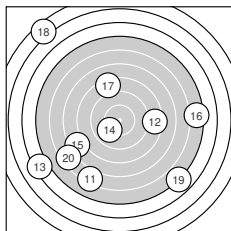

Serie 2:

6.2 ↙	8.4 →	4.2 ↖	9.9 ↙	7.4 ↖
5.4 →	8.3 ↖	2.5 ↖	4.9 ↘	6.4 ↖

beste Teiler: 252.4 (14.), 640.4 (12.), 668.1 (17.)
 Trefferlage: 2.35 mm links, 1.97 mm tief
 Streuwert: 9.17, horizontal: 9.89, vertikal: 8.37



Ergebnis: **196.6** (188)
Serien: 98.9 97.7
Zähler: 11 7 1 1 0 0 0 0 0 0
Innenzehner: 7
Weiteste: 927 (12.), 565 (20.), 445 (4.)
beste Teiler: 46.8 (16.), 56.2 (15.), 71.4 (6.)
Trefferlage: 0.48 mm rechts, 0.34 mm tief
Streuwert: 2.46, horizontal: 2.55, vertikal: 2.37

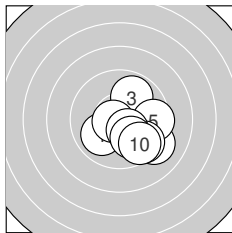
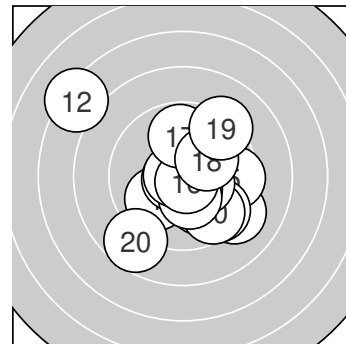

Serie 1:

10.0 ↙	10.0 ↘	9.9 ↗	9.2 ↘	9.5 →
10.7 *	9.6 ↘	10.4 *	10.0 ↘	9.6 ↘

beste Teiler: 71.4 (6.), 139.6 (8.), 227.3 (2.)
Trefferlage: 1.41 mm rechts, 1.18 mm tief
Streuwert: 1.63, horizontal: 1.74, vertikal: 1.52

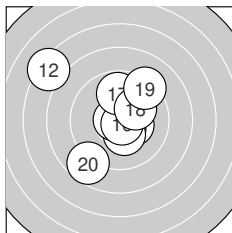

Serie 2:

10.4 *	7.2 ↘	10.5 *	10.3 *	10.7 *
10.8 *	9.8 ↑	10.1 ↗	9.2 ↗	8.7 ↘

beste Teiler: 46.8 (16.), 56.2 (15.), 107.5 (13.)
Trefferlage: 0.45 mm links, 0.49 mm hoch
Streuwert: 2.90, horizontal: 2.97, vertikal: 2.82



Ergebnis: **189.9** (182)
 Serien: 96.0 93.9
 Zähler: 8 8 2 2 0 0 0 0 0 0
 Innenzehner: 6
 Weitester: 931 (18.), 754 (16.), 723 (11.)
 beste Teiler: 12.3 (17.), 90.8 (19.), 121.0 (9.)
 Trefferlage: 1.07 mm links, 0.64 mm tief
 Streuwert: 3.02, horizontal: 3.71, vertikal: 2.11

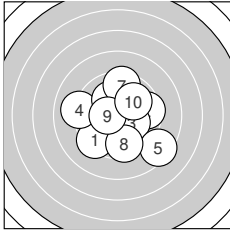
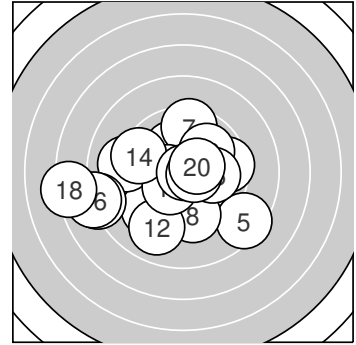

Serie 1:

9.3 ↙	9.5 →	10.2 *	9.1 ←	8.4 ↘
10.1 ↘	9.5 ↑	9.5 ↓	10.5 *	9.9 ↗

beste Teiler: 121.0 (9.), 190.9 (3.), 207.0 (6.)
 Trefferlage: 0.38 mm rechts, 0.27 mm tief
 Streuwert: 2.69, horizontal: 2.86, vertikal: 2.51

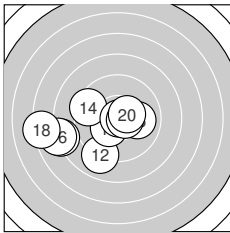

Serie 2:

8.1 ←	9.0 ↙	10.3 *	9.4 ↖	10.0 →
7.9 ←	10.9 *	7.2 ←	10.6 *	10.5 *

beste Teiler: 12.3 (17.), 90.8 (19.), 122.7 (20.)
 Trefferlage: 2.54 mm links, 1.02 mm tief
 Streuwert: 3.07, horizontal: 4.01, vertikal: 1.67



Ergebnis: **178.7** (169)
Serien: 89.4 89.3
Zähler: 3 7 7 2 1 0 0 0 0 0
Innenzehner: 2
Weiteste: 1033 (17.), 789 (11.), 768 (4.)
beste Teiler: 59.6 (9.), 151.4 (15.), 203.0 (14.)
Trefferlage: 0.16 mm links, 1.31 mm hoch
Streuwert: 3.88, horizontal: 4.65, vertikal: 2.92

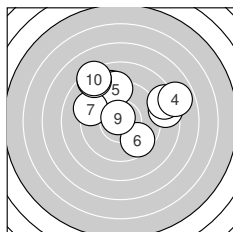
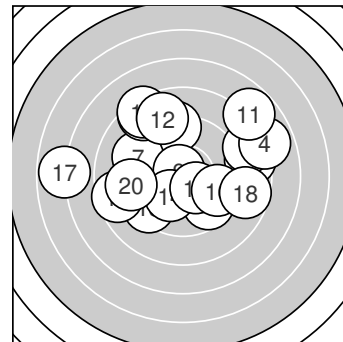

Serie 1:

9.1 ↗	8.5 →	8.5 ↘	7.9 →	9.2 ↑
9.6 ↘	9.2 ←	8.4 ↖	10.7 *	8.3 ↖

beste Teiler: 59.6 (9.), 327.7 (6.), 427.0 (7.)
Trefferlage: 0.77 mm rechts, 2.61 mm hoch
Streuwert: 3.44, horizontal: 4.20, vertikal: 2.46

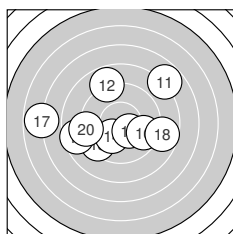

Serie 2:

7.8 ↗	8.8 ↖	9.4 ↙	10.1 ↙	10.3 *
9.7 ↘	6.8 ←	8.7 →	8.6 ←	9.1 ←

beste Teiler: 151.4 (15.), 203.0 (14.), 324.6 (16.)
Trefferlage: 1.11 mm links, 0.01 mm hoch
Streuwert: 4.13, horizontal: 5.10, vertikal: 2.85



Ergebnis: **195.3** (185)
 Serien: 96.8 98.5
 Zähler: 7 11 2 0 0 0 0 0 0 0
 Innenzehner: 4
 Weitestе: 643 (10.), 582 (7.), 428 (19.)
 beste Teiler: 37.4 (8.), 41.2 (1.), 108.6 (13.)
 Trefferlage: 0.98 mm rechts, 0.79 mm tief
 Streuwert: 2.24, horizontal: 2.44, vertikal: 2.01

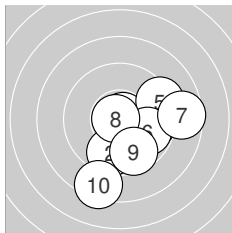
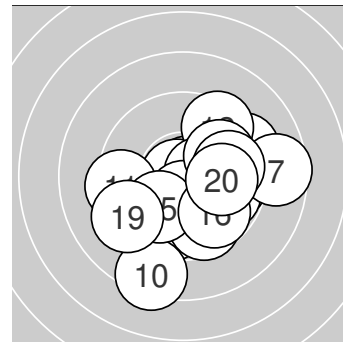

Serie 1:

10.8 *	9.7 ↓	10.1 ↘	9.7 →	9.3 →
9.8 ↘	8.6 →	10.8 *	9.6 ↓	8.4 ↓

beste Teiler: 37.4 (8.), 41.2 (1.), 214.3 (3.)
 Trefferlage: 1.56 mm rechts, 1.22 mm tief
 Streuwert: 2.31, horizontal: 2.36, vertikal: 2.27

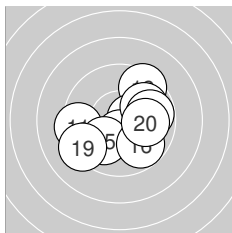

Serie 2:

9.4 ←	9.5 ↗	10.5 *	10.4 *	10.0 ↙
9.8 ↘	9.9 ↗	9.8 →	9.2 ↙	10.0 →

beste Teiler: 108.6 (13.), 128.0 (14.), 240.6 (15.)
 Trefferlage: 0.39 mm rechts, 0.36 mm tief
 Streuwert: 2.15, horizontal: 2.50, vertikal: 1.73



Ergebnis: **148.3** (139)
 Serien: 69.2 79.1
 Zähler: 1 3 4 3 4 5 0 0 0 0
 Innenzehner: 1
 Weitestе: 1487 (8.), 1481 (2.), 1419 (7.)
 beste Teiler: 29.6 (6.), 289.0 (12.), 382.0 (20.)
 Trefferlage: 1.21 mm links, 1.95 mm tief
 Streuwert: 6.94, horizontal: 6.13, vertikal: 7.67

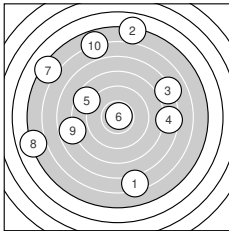
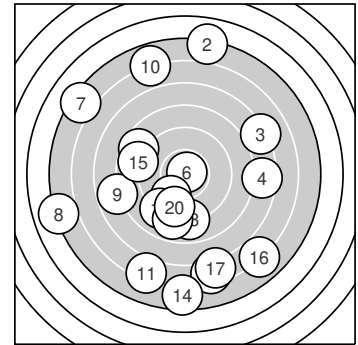

Serie 1:

6.3 ↓	5.0 ↑	7.1 ↗	7.5 →	8.6 ↖
10.8 *	5.3 ↖	5.0 ←	7.8 ←	5.8 ↑

beste Teiler: 29.6 (6.), 592.4 (5.), 791.3 (9.)
 Trefferlage: 1.97 mm links, 2.40 mm hoch
 Streuwert: 7.84, horizontal: 7.90, vertikal: 7.79

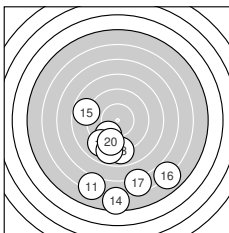

Serie 2:

6.2 ↙	9.8 ↙	8.9 ↓	5.5 ↓	8.8 ←
6.0 ↘	6.5 ↓	9.1 ↙	8.9 ↓	9.4 ↓

beste Teiler: 289.0 (12.), 382.0 (20.), 475.8 (18.)
 Trefferlage: 0.45 mm links, 6.31 mm tief
 Streuwert: 4.30, horizontal: 3.95, vertikal: 4.63



Ergebnis: **176.6** (165)
 Serien: 85.9 90.7
 Zähler: 3 5 6 6 0 0 0 0 0 0
 Innenzehner: 2
 Weitestе: 978 (7.), 862 (1.), 836 (18.)
 beste Teiler: 37.3 (19.), 81.3 (17.), 210.7 (6.)
 Trefferlage: 1.95 mm rechts, 1.79 mm hoch
 Streuwert: 3.85, horizontal: 3.83, vertikal: 3.87

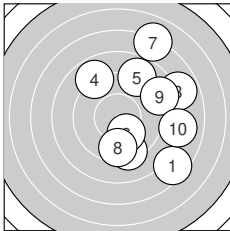
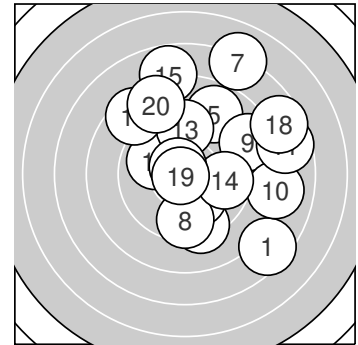

Serie 1:
 7.5 ↘ 9.3 ↓ 7.9 → 8.9 ↖ 8.9 ↗
 10.1 ↘ 7.0 ↗ 9.5 ↓ 8.7 → 8.1 →
 beste Teiler: 210.7 (6.), 357.0 (8.), 415.9 (2.)
 Trefferlage: 3.16 mm rechts, 0.72 mm hoch
 Streuwert: 4.06, horizontal: 3.33, vertikal: 4.68

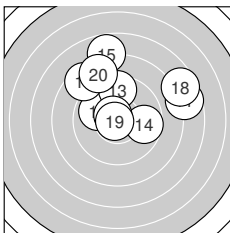

Serie 2:
 7.7 → 9.9 ↖ 9.5 ↑ 9.7 → 7.8 ↑
 8.5 ↖ 10.6 * 7.6 ↗ 10.8 * 8.6 ↖
 beste Teiler: 37.3 (19.), 81.3 (17.), 256.0 (12.)
 Trefferlage: 0.75 mm rechts, 2.86 mm hoch
 Streuwert: 3.45, horizontal: 4.07, vertikal: 2.69



Ergebnis: **155.6** (148)
Serien: 74.7 80.9
Zähler: 3 2 7 4 2 0 1 0 0 0
Innenzehner: 0
Weiteste: 2662 (8.), 1584 (9.), 1176 (16.)
beste Teiler: 207.9 (11.), 235.9 (7.), 247.8 (10.)
Trefferlage: 1.00 mm links, 0.92 mm hoch
Streuwert: 6.93, horizontal: 7.33, vertikal: 6.50

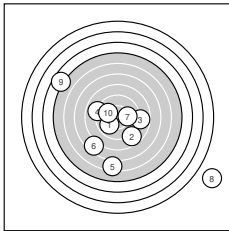
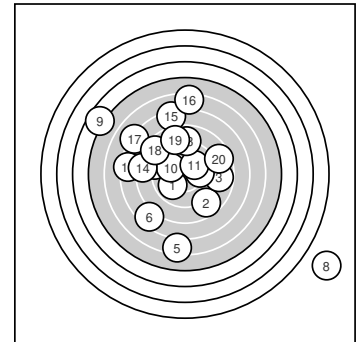

Serie 1:

9.9 ↙	8.7 ↘	8.8 →	9.0 ←	6.3 ↓
7.4 ↙	10.0 →	0.0 ↘	4.6 ↖	10.0 ↖

beste Teiler: 235.9 (7.), 247.8 (10.), 260.0 (1.)
Trefferlage: 0.41 mm rechts, 2.83 mm tief
Streuwert: 8.15, horizontal: 9.37, vertikal: 6.71

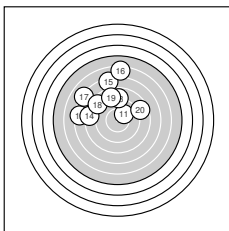

Serie 2:

10.1 ↗	7.3 ←	8.9 ↑	8.3 ←	7.2 ↑
6.2 ↑	7.1 ↖	8.5 ↘	8.7 ↑	8.6 →

beste Teiler: 207.9 (11.), 521.5 (13.), 560.8 (19.)
Trefferlage: 2.43 mm links, 4.68 mm hoch
Streuwert: 4.12, horizontal: 4.61, vertikal: 3.56



Ergebnis: **161.3** (153)
Serien: 80.3 81.0
Zähler: 2 3 5 7 2 1 0 0 0 0
Innenzehner: 0
Weiteste: 1278 (3.), 1175 (19.), 1130 (10.)
beste Teiler: 220.4 (5.), 228.6 (17.), 302.9 (13.)
Trefferlage: 0.82 mm links, 0.72 mm tief
Streuwert: 5.62, horizontal: 6.67, vertikal: 4.33

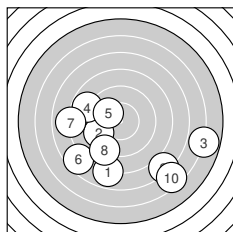
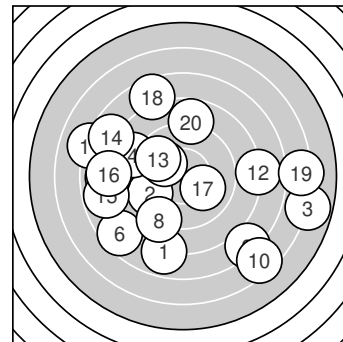

Serie 1:

7.9 ↓ 9.5 ↙ 5.8 →
 7.6 ↘ 8.0 ← 9.0 ↙

beste Teiler: 220.4 (5.), 367.6 (2.), 491.4 (8.)
Trefferlage: 0.16 mm links, 3.43 mm tief
Streuwert: 5.37, horizontal: 6.63, vertikal: 3.73

8.8 ↖ 10.1 ↖
 7.2 ↘ 6.4 ↘

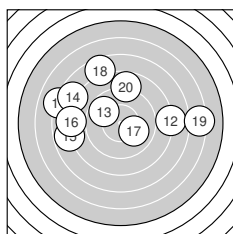

Serie 2:

7.1 ↖ 8.0 → 9.7 ↖ 7.7 ↖ 7.8 ←
 8.0 ← 10.0 ↘ 7.6 ↗ 6.3 → 8.8 ↑

beste Teiler: 228.6 (17.), 302.9 (13.), 548.8 (20.)
Trefferlage: 1.49 mm links, 1.98 mm hoch
Streuwert: 5.40, horizontal: 7.00, vertikal: 3.07



Ergebnis: **108.1** (101)
 Serien: 64.3 43.8
 Zähler: 1 2 2 2 3 3 1 1 1 1
 Innenzehner: 1
 Weitesten: 4876 (9.), 3160 (13.), 2503 (12.)
 beste Teiler: 142.4 (14.), 267.5 (7.), 403.8 (4.)
 Trefferlage: 5.44 mm links, 2.25 mm hoch
 Streuwert: 12.76, horizontal: 14.87, vertikal: 10.22

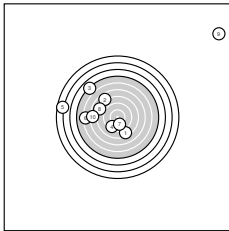
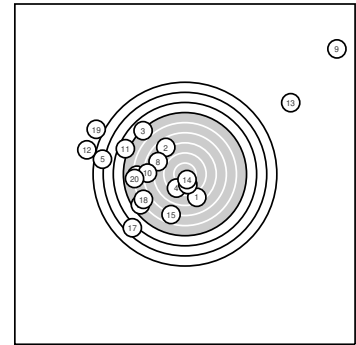

Serie 1:

8.4 ↘	7.7 ↘	5.0 ↘	9.3 ↙	2.6 ←
6.2 ←	9.9 ↓	8.0 ↖	0.0 ↗	7.2 ←

beste Teiler: 267.5 (7.), 403.8 (4.), 644.9 (1.)
 Trefferlage: 2.42 mm links, 4.34 mm hoch
 Streuwert: 13.33, horizontal: 15.60, vertikal: 10.58

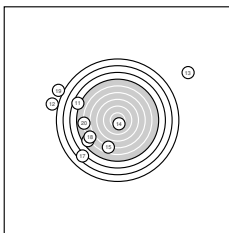

Serie 2:

4.5 ↖	0.0 ←	0.0 ↗	10.4 *	6.7 ↓
5.6 ↙	3.5 ↙	6.1 ↙	1.1 ↖	5.9 ←

beste Teiler: 142.4 (14.), 1058.4 (15.), 1202.5 (18.)
 Trefferlage: 8.46 mm links, 0.15 mm hoch
 Streuwert: 12.28, horizontal: 14.25, vertikal: 9.93



Ergebnis: **174.9** (166)
 Serien: 89.7 85.2
 Zähler: 3 8 3 4 2 0 0 0 0 0
 Innenzehner: 2
 Weitester: 1069 (20.), 1025 (18.), 933 (2.)
 beste Teiler: 74.9 (9.), 115.7 (12.), 231.2 (1.)
 Trefferlage: 0.27 mm rechts, 0.69 mm hoch
 Streuwert: 4.49, horizontal: 5.47, vertikal: 3.21

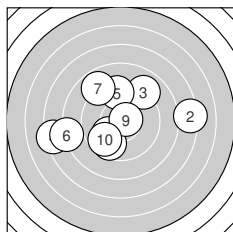
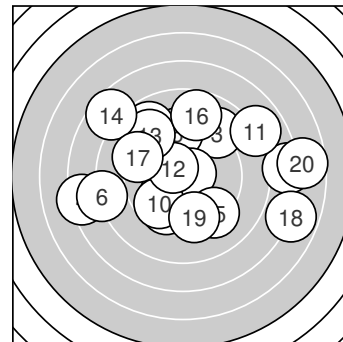

Serie 1:

10.0 ↙	7.2 →	9.0 ↗	7.3 ←	9.4 ↑
8.0 ←	8.8 ↘	9.6 ↘	10.7 *	9.7 ↙

beste Teiler: 74.9 (9.), 231.2 (1.), 320.3 (10.)
 Trefferlage: 1.18 mm links, 0.21 mm hoch
 Streuwert: 4.13, horizontal: 5.09, vertikal: 2.86

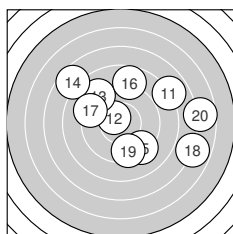

Serie 2:

7.9 ↗	10.5 *	9.1 ↘	7.6 ↘	9.2 ↘
8.7 ↑	9.2 ↖	6.9 →	9.4 ↓	6.7 →

beste Teiler: 115.7 (12.), 379.4 (19.), 426.3 (15.)
 Trefferlage: 1.73 mm rechts, 1.16 mm hoch
 Streuwert: 4.77, horizontal: 5.71, vertikal: 3.61



Ergebnis: **151.0** (142)
 Serien: 78.7 72.3
 Zähler: 1 3 3 7 2 4 0 0 0 0
 Innenzehner: 1
 Weitester: 1425 (19.), 1359 (13.), 1338 (3.)
 beste Teiler: 197.4 (6.), 328.8 (8.), 406.0 (4.)
 Trefferlage: 0.21 mm links, 0.73 mm hoch
 Streuwert: 6.64, horizontal: 6.68, vertikal: 6.60

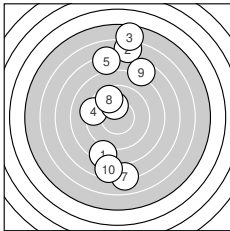
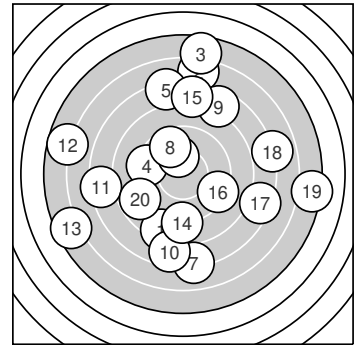

Serie 1:

8.3 ↘	6.4 ↑	5.6 ↑	9.3 ←	7.2 ↑
10.2 *	7.0 ↓	9.6 ↗	7.6 ↗	7.5 ↓

beste Teiler: 197.4 (6.), 328.8 (8.), 406.0 (4.)
 Trefferlage: 0.28 mm links, 2.27 mm hoch
 Streuwert: 6.05, horizontal: 2.39, vertikal: 8.22

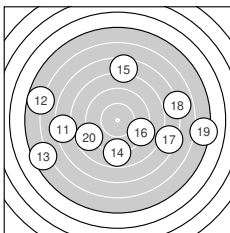

Serie 2:

7.3 ←	5.7 ←	5.5 ←	8.8 ↓	7.5 ↑
9.2 ↘	7.3 →	6.9 →	5.3 →	8.8 ↖

beste Teiler: 430.2 (16.), 531.0 (14.), 543.0 (20.)
 Trefferlage: 0.14 mm links, 0.80 mm tief
 Streuwert: 7.33, horizontal: 9.40, vertikal: 4.37



Ergebnis: **162.6** (155)
 Serien: 85.5 77.1
 Zähler: 3 6 5 2 2 0 1 0 0 1
 Innenzehner: 1
 Weitester: 2417 (13.), 1634 (15.), 1165 (2.)
 beste Teiler: 195.7 (1.), 217.6 (20.), 236.2 (18.)
 Trefferlage: 0.84 mm links, 1.59 mm tief
 Streuwert: 6.25, horizontal: 7.31, vertikal: 4.97

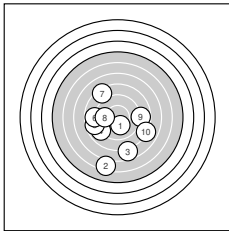
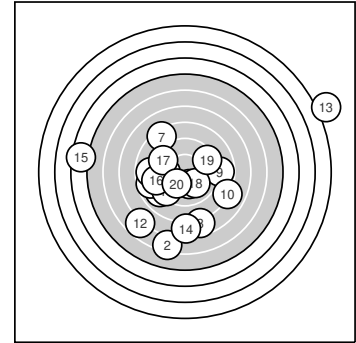

Serie 1:

10.2 *	6.3 ↓	7.6 ↓	9.0 ↙	8.7 ←
8.8 ←	8.3 ↘	9.8 ←	8.8 →	8.0 ↘

beste Teiler: 195.7 (1.), 299.0 (8.), 498.8 (4.)
 Trefferlage: 0.89 mm links, 2.37 mm tief
 Streuwert: 4.51, horizontal: 4.39, vertikal: 4.64

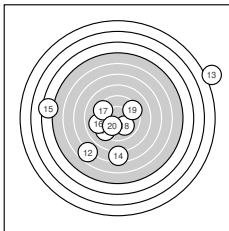

Serie 2:

9.3 ↙	6.7 ↙	1.3 →	7.4 ↓	4.4 ←
9.1 ←	9.4 ↘	10.0 ↘	9.4 →	10.1 ↙

beste Teiler: 217.6 (20.), 236.2 (18.), 386.1 (17.)
 Trefferlage: 0.79 mm links, 0.82 mm tief
 Streuwert: 7.84, horizontal: 9.67, vertikal: 5.41



Ergebnis: **157.9** (149)
Serien: 84.5 73.4
Zähler: 2 3 5 5 3 1 1 0 0 0
Innenzehner: 2
Weiteste: 1513 (1.), 1474 (17.), 1189 (6.)
beste Teiler: 150.6 (4.), 173.7 (10.), 274.3 (8.)
Trefferlage: 1.42 mm rechts, 1.29 mm tief
Streuwert: 6.05, horizontal: 6.60, vertikal: 5.44

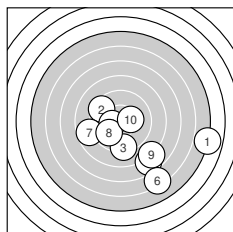
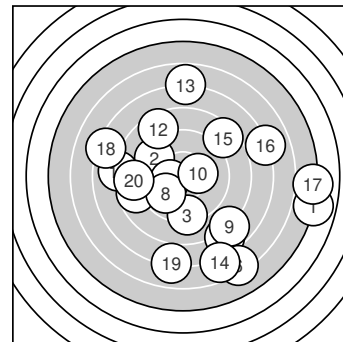

Serie 1:

4.9 →	9.4 ↖	9.2 ↓	10.4 *	7.6 ↘
6.2 ↘	8.7 ←	9.9 ↙	7.9 ↘	10.3 *

beste Teiler: 150.6 (4.), 173.7 (10.), 274.3 (8.)
Trefferlage: 2.12 mm rechts, 3.23 mm tief
Streuwert: 4.89, horizontal: 5.86, vertikal: 3.66

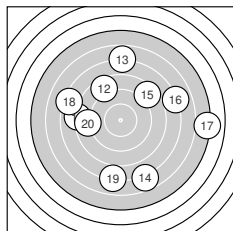

Serie 2:

8.0 ←	8.5 ↘	6.8 ↑	6.7 ↘	8.4 ↗
7.0 →	5.1 →	7.2 ↖	7.0 ↓	8.7 ←

beste Teiler: 557.8 (20.), 605.6 (12.), 628.7 (15.)
Trefferlage: 0.73 mm rechts, 0.63 mm hoch
Streuwert: 6.97, horizontal: 7.51, vertikal: 6.39



Ergebnis: **72.7** (67)
Serien: 50.2 22.5
Zähler: 1 0 1 1 3 2 2 1 1 1
Innenzehner: 0
Weiteste: 5158 (13.), 4690 (11.), 3474 (14.)
beste Teiler: 208.5 (3.), 514.3 (8.), 938.9 (9.)
Trefferlage: 0.02 mm links, 13.14 mm tief
Streuwert: 15.29, horizontal: 16.09, vertikal: 14.46

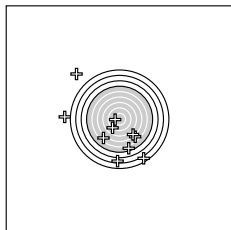
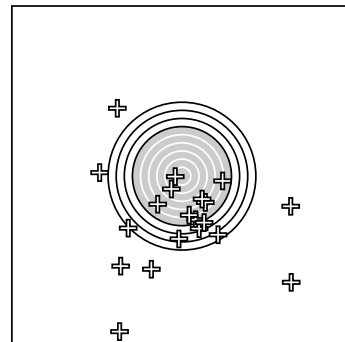

Serie 1:

0.0 ↘	6.4 ↙	10.1 ←	0.0 ←	6.6 ↘
5.3 ↓	2.5 ↘	8.9 ↙	7.2 ↘	3.2 ↓

beste Teiler: 208.5 (3.), 514.3 (8.), 938.9 (9.)
Trefferlage: 3.03 mm links, 5.67 mm tief
Streuwert: 11.67, horizontal: 11.78, vertikal: 11.55

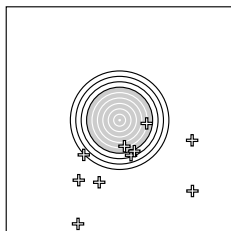

Serie 2:

0.0 ↘	0.0 ↙	0.0 ↙	0.0 →	4.2 ↓
5.9 →	1.7 ↙	0.0 ↙	6.1 ↓	4.6 ↘

beste Teiler: 1221.3 (19.), 1259.8 (16.), 1583.4 (20.)
Trefferlage: 2.98 mm rechts, 20.61 mm tief
Streuwert: 16.90, horizontal: 19.68, vertikal: 13.55



Ergebnis: **170.9** (161)
Serien: 83.2 87.7
Zähler: 1 7 6 4 2 0 0 0 0 0
Innenzehner: 1
Weiteste: 1071 (7.), 1049 (12.), 998 (6.)
beste Teiler: 170.5 (10.), 270.4 (16.), 313.7 (8.)
Trefferlage: 0.23 mm links, 3.09 mm hoch
Streuwert: 4.23, horizontal: 5.21, vertikal: 2.95

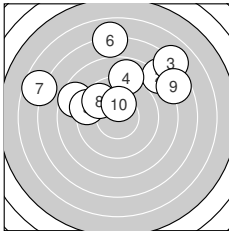
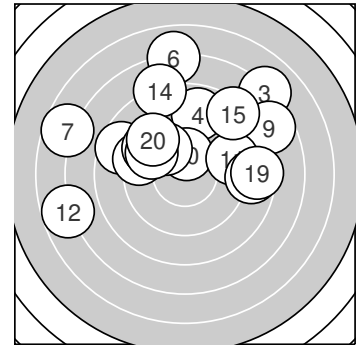

Serie 1:

8.6 ↖	7.9 ↗	7.1 ↗	8.9 ↑	9.3 ↖
7.0 ↑	6.7 ↖	9.7 ↖	7.7 ↗	10.3 *

beste Teiler: 170.5 (10.), 313.7 (8.), 413.9 (5.)
Trefferlage: 0.21 mm links, 4.23 mm hoch
Streuwert: 4.38, horizontal: 5.57, vertikal: 2.70

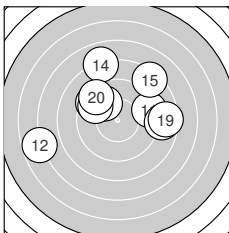

Serie 2:

9.2 →	6.8 ↖	9.4 ↖	8.0 ↑	8.3 ↗
9.9 ↘	9.6 ↖	8.7 →	8.5 →	9.3 ↘

beste Teiler: 270.4 (16.), 338.6 (17.), 385.1 (13.)
Trefferlage: 0.25 mm links, 1.94 mm hoch
Streuwert: 4.15, horizontal: 5.12, vertikal: 2.86



Ergebnis: **120.9** (113)
 Serien: 56.5 64.4
 Zähler: 0 2 2 5 2 4 2 0 2 0
 Innenzehner: 0
 Weitesten: 4027 (1.), 2060 (15.), 2041 (5.)
 beste Teiler: 382.0 (2.), 428.5 (20.), 632.5 (13.)
 Trefferlage: 2.82 mm rechts, 4.05 mm tief
 Streuwert: 10.34, horizontal: 9.79, vertikal: 10.86

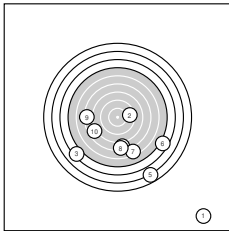
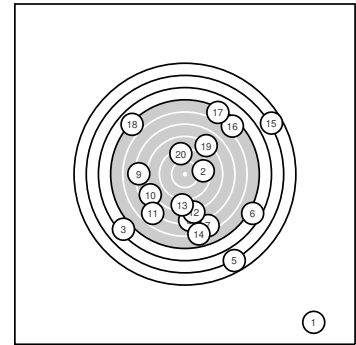

Serie 1:

0.0 ↘	9.4 →	4.2 ↙	7.3 ↓	2.8 ↘
4.5 ↘	6.3 ↓	7.2 ↓	7.2 ←	7.6 ↙

beste Teiler: 382.0 (2.), 827.8 (10.), 902.5 (4.)
 Trefferlage: 3.21 mm rechts, 9.98 mm tief
 Streuwert: 10.44, horizontal: 11.69, vertikal: 9.02

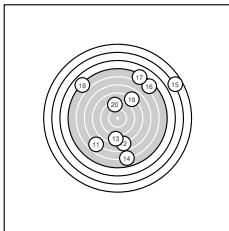

Serie 2:

6.8 ↙	7.8 ↓	8.4 ↓	5.9 ↓	2.7 ↗
5.4 ↗	5.2 ↗	5.0 ↘	8.0 ↗	9.2 ↑

beste Teiler: 428.5 (20.), 632.5 (13.), 729.6 (19.)
 Trefferlage: 2.43 mm rechts, 1.88 mm hoch
 Streuwert: 8.79, horizontal: 8.09, vertikal: 9.45



Ergebnis: **186.7** (177)
 Serien: 93.8 92.9
 Zähler: 5 8 6 1 0 0 0 0 0 0
 Innenzehner: 3
 Weitester: 757 (4.), 654 (19.), 644 (17.)
 beste Teiler: 138.2 (20.), 154.4 (18.), 192.6 (9.)
 Trefferlage: 0.59 mm rechts, 0.12 mm tief
 Streuwert: 3.20, horizontal: 3.88, vertikal: 2.33

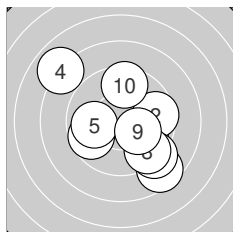
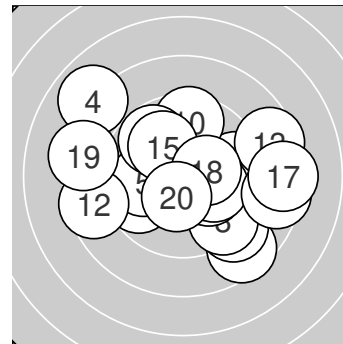

Serie 1:

9.9 ↘	9.6 →	9.7 ←	7.9 ↘	9.9 ←
8.6 ↘	9.1 ↘	9.4 ↘	10.2 *	9.5 ↑

beste Teiler: 192.6 (9.), 255.2 (5.), 266.1 (1.)
 Trefferlage: 0.62 mm rechts, 0.56 mm tief
 Streuwert: 3.10, horizontal: 3.25, vertikal: 2.94

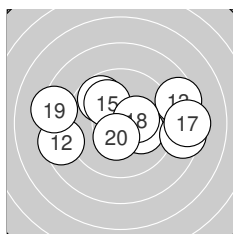

Serie 2:

9.7 ↘	8.6 ←	8.6 →	10.1 →	10.0 ↘
8.5 →	8.4 →	10.3 *	8.3 ←	10.4 *

beste Teiler: 138.2 (20.), 154.4 (18.), 210.0 (14.)
 Trefferlage: 0.57 mm rechts, 0.32 mm hoch
 Streuwert: 3.44, horizontal: 4.61, vertikal: 1.54



Ergebnis: **184.0** (176)
 Serien: 96.0 88.0
 Zähler: 6 8 4 1 0 1 0 0 0 0
 Innenzehner: 4
 Weitester: 1411 (15.), 864 (12.), 727 (19.)
 beste Teiler: 86.0 (18.), 131.7 (16.), 181.1 (13.)
 Trefferlage: 0.57 mm links, 0.01 mm hoch
 Streuwert: 3.84, horizontal: 2.87, vertikal: 4.61

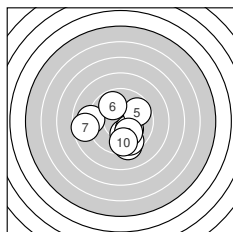
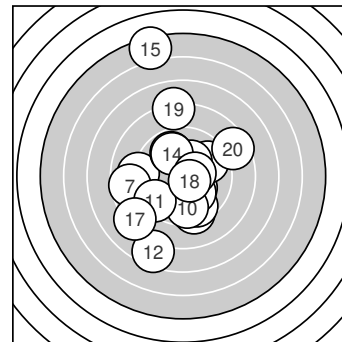

Serie 1:

9.0 ←	10.1 ↓	9.3 ↓	10.2 *	9.7 ↗
9.8 ↖	8.6 ←	9.6 ↓	10.1 ↓	9.6 ↓

beste Teiler: 187.7 (4.), 205.2 (2.), 217.0 (9.)
 Trefferlage: 0.27 mm links, 1.20 mm tief
 Streuwert: 2.48, horizontal: 2.80, vertikal: 2.11

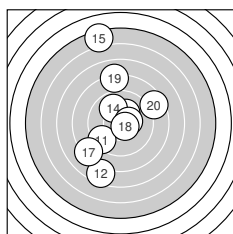

Serie 2:

9.4 ↗	7.5 ↓	10.2 *	9.9 ↖	5.3 ↑
10.4 *	8.2 ↗	10.6 *	8.0 ↑	8.5 ↗

beste Teiler: 86.0 (18.), 131.7 (16.), 181.1 (13.)
 Trefferlage: 0.88 mm links, 1.23 mm hoch
 Streuwert: 4.82, horizontal: 3.05, vertikal: 6.09



Ergebnis: **186.1** (177)
 Serien: 92.8 93.3
 Zähler: 5 8 6 1 0 0 0 0 0 0
 Innenzehner: 3
 Weitestе: 855 (11.), 692 (3.), 691 (5.)
 beste Teiler: 121.9 (7.), 122.8 (19.), 151.6 (15.)
 Trefferlage: 0.71 mm links, 1.05 mm hoch
 Streuwert: 3.16, horizontal: 3.11, vertikal: 3.22

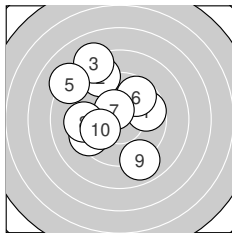
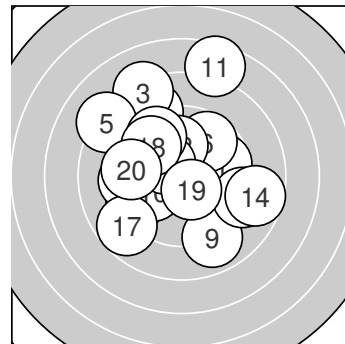

Serie 1:

9.7 →	8.9 ↘	8.2 ↘	9.4 ←	8.2 ↘
9.7 ↗	10.5 *	9.3 ←	8.9 ↘	10.0 ←

beste Teiler: 121.9 (7.), 244.1 (10.), 310.9 (1.)
 Trefferlage: 1.38 mm links, 1.18 mm hoch
 Streuwert: 3.11, horizontal: 2.90, vertikal: 3.31

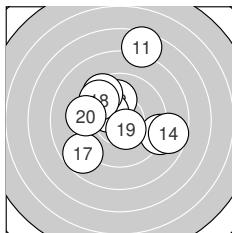

Serie 2:

7.5 ↑	10.0 ↑	9.0 →	8.7 →	10.3 *
9.5 ↘	8.7 ↙	9.7 ↘	10.5 *	9.4 ←

beste Teiler: 122.8 (19.), 151.6 (15.), 230.0 (12.)
 Trefferlage: 0.04 mm links, 0.93 mm hoch
 Streuwert: 3.30, horizontal: 3.31, vertikal: 3.29



Ergebnis: **185.2** (178)
Serien: 92.5 92.7
Zähler: 6 6 8 0 0 0 0 0 0 0
Innenzehner: 1
Weiteste: 721 (17.), 686 (12.), 644 (10.)
beste Teiler: 134.8 (2.), 204.8 (11.), 222.4 (4.)
Trefferlage: 1.31 mm rechts, 0.29 mm hoch
Streuwert: 3.16, horizontal: 3.13, vertikal: 3.18

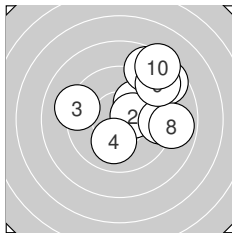
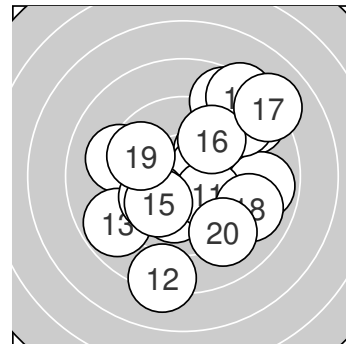

Serie 1:

10.0 ↗	10.4 *	9.2 ←	10.1 ↓	8.7 ↗
9.3 →	8.6 ↗	8.9 →	8.9 ↗	8.4 ↗

beste Teiler: 134.8 (2.), 222.4 (4.), 229.8 (1.)
Trefferlage: 2.21 mm rechts, 1.75 mm hoch
Streuwert: 2.67, horizontal: 2.84, vertikal: 2.50

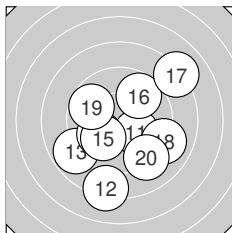

Serie 2:

10.1 ↘	8.2 ↓	8.8 ↙	10.0 ↙	10.0 ↙
9.7 ↗	8.1 ↗	9.0 ↘	9.7 ↖	9.1 ↘

beste Teiler: 204.8 (11.), 239.2 (15.), 242.4 (14.)
Trefferlage: 0.40 mm rechts, 1.16 mm tief
Streuwert: 3.26, horizontal: 3.29, vertikal: 3.23



Ergebnis: **178.5** (169)
 Serien: 90.4 88.1
 Zähler: 1 11 5 2 1 0 0 0 0 0
 Innenzehner: 1
 Weitester: 1081 (18.), 864 (9.), 794 (20.)
 beste Teiler: 112.0 (11.), 267.3 (10.), 298.0 (14.)
 Trefferlage: 0.99 mm links, 0.42 mm hoch
 Streuwert: 3.93, horizontal: 4.60, vertikal: 3.12

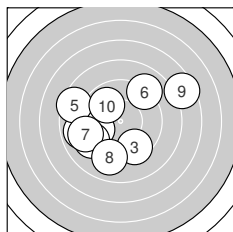
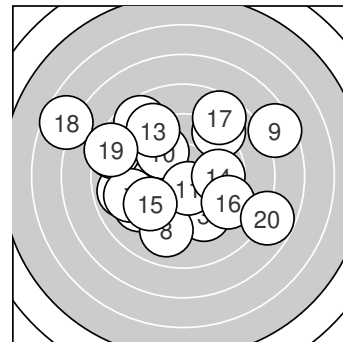

Serie 1:

8.9 ←	9.7 ←	9.5 ↘	9.2 ←	8.5 ←
9.0 ↗	9.1 ←	9.1 ↓	7.5 →	9.9 ↖

beste Teiler: 267.3 (10.), 315.2 (2.), 369.1 (3.)
 Trefferlage: 1.25 mm links, 0.24 mm tief
 Streuwert: 3.66, horizontal: 4.25, vertikal: 2.96

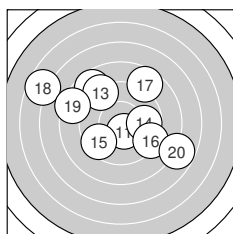

Serie 2:

10.5 *	8.6 ↘	9.1 ↘	9.8 →	9.5 ←
9.2 ↘	8.6 ↗	6.6 ↖	8.4 ←	7.8 ↘

beste Teiler: 112.0 (11.), 298.0 (14.), 361.8 (15.)
 Trefferlage: 0.73 mm links, 1.09 mm hoch
 Streuwert: 4.32, horizontal: 5.14, vertikal: 3.28



Ergebnis: **150.3** (140)
 Serien: 75.6 74.7
 Zähler: 0 2 6 5 5 1 1 0 0 0
 Innenzehner: 0
 Weitestе: 1510 (11.), 1352 (2.), 1227 (12.)
 beste Teiler: 353.2 (17.), 430.4 (9.), 575.5 (18.)
 Trefferlage: 0.43 mm rechts, 1.88 mm tief
 Streuwert: 6.44, horizontal: 7.36, vertikal: 5.37

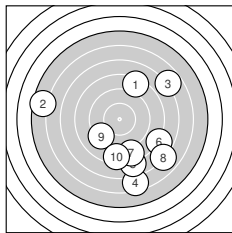
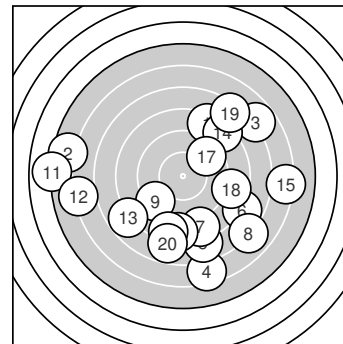

Serie 1:

8.3 ↗	5.5 ←	6.8 ↘	6.4 ↓	7.8 ↓
7.8 ↘	8.5 ↓	6.9 ↘	9.2 ↙	8.4 ↓

beste Teiler: 430.4 (9.), 616.0 (7.), 648.3 (10.)
 Trefferlage: 1.55 mm rechts, 2.92 mm tief
 Streuwert: 6.14, horizontal: 6.32, vertikal: 5.95

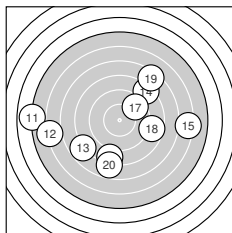

Serie 2:

4.9 ←	6.0 ←	7.8 ↙	8.2 ↗	6.2 →
8.3 ↓	9.5 ↗	8.7 →	7.3 ↗	7.8 ↓

beste Teiler: 353.2 (17.), 575.5 (18.), 661.2 (16.)
 Trefferlage: 0.68 mm links, 0.84 mm tief
 Streuwert: 6.88, horizontal: 8.46, vertikal: 4.82



Ergebnis: **143.0** (135)
 Serien: 75.1 67.9
 Zähler: 1 5 4 2 3 1 2 1 0 0
 Innenzehner: 1
 Weitesten: 3198 (12.), 1781 (6.), 1641 (15.)
 beste Teiler: 189.5 (2.), 274.5 (9.), 311.7 (19.)
 Trefferlage: 1.75 mm rechts, 3.55 mm hoch
 Streuwert: 8.20, horizontal: 9.93, vertikal: 5.97

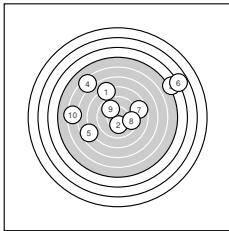
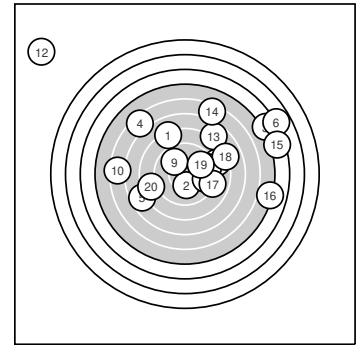

Serie 1:

8.1 ↖	10.2 *	4.6 ↗	6.4 ↘	7.6 ↙
3.8 ↗	8.6 ↗	9.5 →	9.9 ↘	6.4 ←

beste Teiler: 189.5 (2.), 274.5 (9.), 361.8 (8.)
 Trefferlage: 0.73 mm rechts, 3.00 mm hoch
 Streuwert: 7.13, horizontal: 8.92, vertikal: 4.69

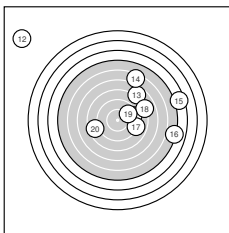

Serie 2:

9.3 →	0.0 ↘	7.7 ↗	6.3 ↗	4.4 →
5.0 →	9.0 →	8.0 ↗	9.7 ↗	8.5 ←

beste Teiler: 311.7 (19.), 411.2 (11.), 495.9 (17.)
 Trefferlage: 2.76 mm rechts, 4.11 mm hoch
 Streuwert: 9.46, horizontal: 11.25, vertikal: 7.25



Ergebnis: **165.1** (157)
Serien: 83.4 81.7
Zähler: 1 5 4 10 0 0 0 0 0 0
Innenzehner: 1
Weiteste: 983 (4.), 956 (17.), 954 (7.)
beste Teiler: 183.6 (5.), 315.5 (12.), 457.0 (3.)
Trefferlage: 0.30 mm rechts, 0.29 mm tief
Streuwert: 5.14, horizontal: 6.07, vertikal: 4.01

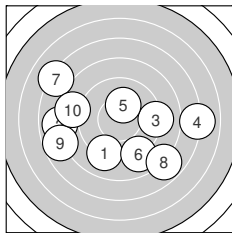
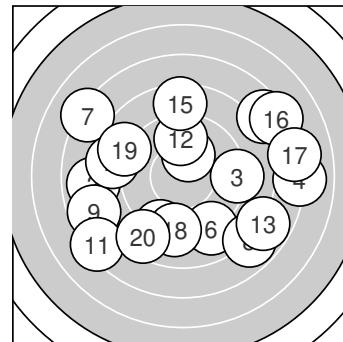

Serie 1:

9.1 ↙	7.9 ←	9.1 →	7.0 →	10.2 *
9.0 ↘	7.1 ↖	7.8 ↘	7.7 ←	8.5 ←

beste Teiler: 183.6 (5.), 457.0 (3.), 464.6 (1.)
Trefferlage: 0.80 mm links, 0.98 mm tief
Streuwert: 5.07, horizontal: 6.37, vertikal: 3.29

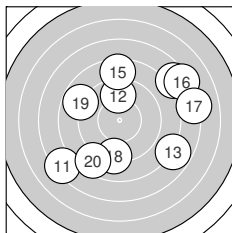

Serie 2:

7.3 ↙	9.7 ↑	7.8 ↘	7.6 ↗	8.5 ↑
7.3 ↗	7.1 →	9.1 ↓	8.8 ↖	8.5 ↙

beste Teiler: 315.5 (12.), 458.5 (18.), 542.7 (19.)
Trefferlage: 1.41 mm rechts, 0.38 mm hoch
Streuwert: 5.31, horizontal: 5.87, vertikal: 4.69



Ergebnis: **141.9** (135)
 Serien: 75.6 66.3
 Zähler: 1 2 3 6 3 4 0 1 0 0
 Innenzehner: 0
 Weitestе: 1874 (19.), 1485 (5.), 1478 (12.)
 beste Teiler: 246.9 (4.), 405.5 (6.), 428.8 (14.)
 Trefferlage: 0.56 mm rechts, 4.03 mm hoch
 Streuwert: 7.00, horizontal: 8.67, vertikal: 4.78

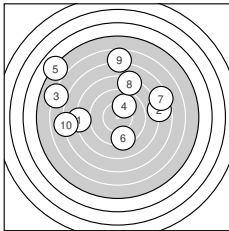
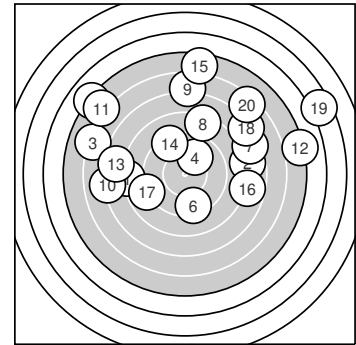

Serie 1:

8.1 ←	7.8 →	6.1 ↖	10.0 ↗	5.0 ↘
9.3 ↓	7.4 ↗	8.2 ↑	6.7 ↑	7.0 ←

beste Teiler: 246.9 (4.), 405.5 (6.), 677.7 (8.)
 Trefferlage: 1.92 mm links, 3.16 mm hoch
 Streuwert: 6.27, horizontal: 7.56, vertikal: 4.63

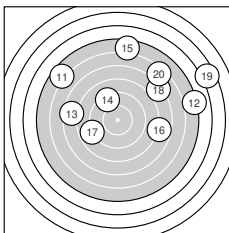

Serie 2:

5.6 ↘	5.0 →	7.5 ←	9.2 ↘	5.5 ↑
7.8 →	8.8 ←	7.1 ↗	3.5 ↗	6.3 ↗

beste Teiler: 428.8 (14.), 528.3 (17.), 800.8 (16.)
 Trefferlage: 3.05 mm rechts, 4.90 mm hoch
 Streuwert: 7.51, horizontal: 9.37, vertikal: 5.01



Ergebnis: **139.8** (130)
 Serien: 69.4 70.4
 Zähler: 1 1 3 5 7 2 0 0 0 0
 Innenzehner: 1
 Weitesten: 3056 (9.), 1423 (19.), 1375 (15.)
 beste Teiler: 69.8 (5.), 473.2 (4.), 524.9 (18.)
 Trefferlage: 1.03 mm links, 0.07 mm hoch
 Streuwert: 8.37, horizontal: 7.26, vertikal: 9.36

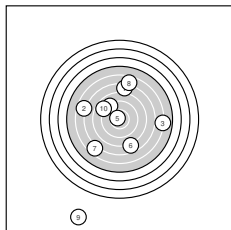
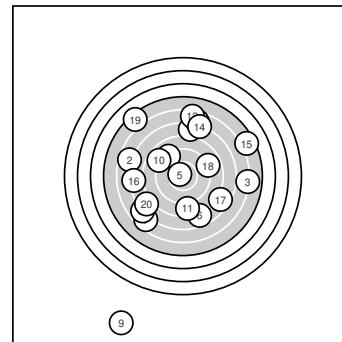

Serie 1:

7.3 ↑	6.7 ↖	6.0 →	9.1 ↘	10.7 *
7.7 ↓	6.6 ↙	6.6 ↑	0.0 ↓	8.7 ↖

beste Teiler: 69.8 (5.), 473.2 (4.), 551.6 (10.)
 Trefferlage: 1.74 mm links, 1.52 mm tief
 Streuwert: 9.41, horizontal: 7.23, vertikal: 11.17

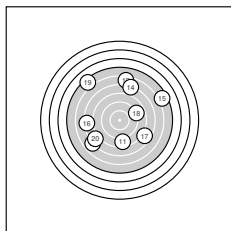

Serie 2:

8.4 ↓	6.9 ↙	6.3 ↑	6.9 ↑	5.5 ↗
7.2 ←	7.6 ↘	8.9 ↗	5.3 ↘	7.4 ↙

beste Teiler: 524.9 (18.), 626.2 (11.), 848.0 (17.)
 Trefferlage: 0.32 mm links, 1.67 mm hoch
 Streuwert: 7.49, horizontal: 7.60, vertikal: 7.37



Ergebnis: **156.5** (147)
 Serien: 88.1 68.4
 Zähler: 1 5 4 5 2 2 0 1 0 0
 Innenzehner: 1
 Weitester: 1842 (12.), 1309 (13.), 1294 (20.)
 beste Teiler: 176.5 (3.), 270.2 (10.), 311.9 (2.)
 Trefferlage: 1.91 mm links, 0.08 mm hoch
 Streuwert: 6.23, horizontal: 7.06, vertikal: 5.27

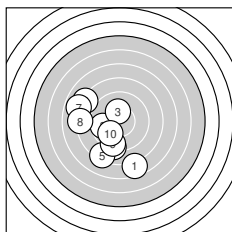
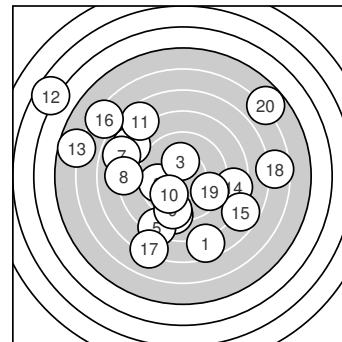

Serie 1:

7.6 ↓	9.7 ←	10.2 *	9.1 ↓	8.2 ↓
8.1 ↖	7.9 ←	8.1 ←	9.3 ↓	9.9 ↓

beste Teiler: 176.5 (3.), 270.2 (10.), 311.9 (2.)
 Trefferlage: 2.81 mm links, 1.77 mm tief
 Streuwert: 3.55, horizontal: 3.21, vertikal: 3.86

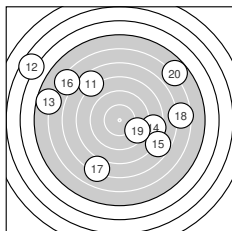

Serie 2:

7.6 ↖	3.6 ↖	5.7 ←	8.5 →	7.7 ↘
6.3 ↖	7.1 ↓	6.6 →	9.5 ↘	5.8 ↗

beste Teiler: 365.5 (19.), 615.8 (14.), 807.5 (15.)
 Trefferlage: 1.01 mm links, 1.94 mm hoch
 Streuwert: 8.03, horizontal: 9.65, vertikal: 6.00



Ergebnis: **196.9** (186)
 Serien: 98.8 98.1
 Zähler: 9 8 3 0 0 0 0 0 0 0
 Innenzehner: 7
 Weitestе: 515 (11.), 509 (3.), 503 (4.)
 beste Teiler: 51.0 (18.), 69.8 (8.), 97.3 (2.)
 Trefferlage: 0.37 mm links, 0.93 mm hoch
 Streuwert: 2.17, horizontal: 2.40, vertikal: 1.92

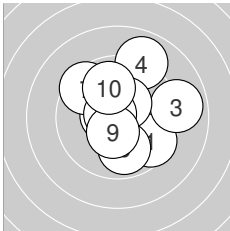
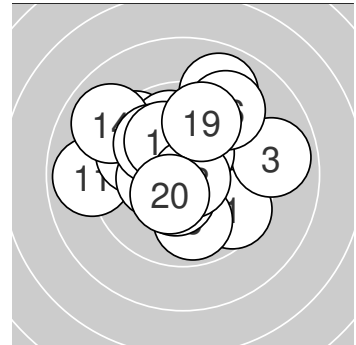

Serie 1:

9.6 ↘	10.6 *	8.9 →	8.9 ↗	10.4 *
9.9 ↓	9.5 ↙	10.7 *	10.4 *	9.9 ↖

beste Teiler: 69.8 (8.), 97.3 (2.), 131.2 (9.)
 Trefferlage: 0.56 mm rechts, 0.63 mm hoch
 Streuwert: 2.22, horizontal: 2.21, vertikal: 2.22

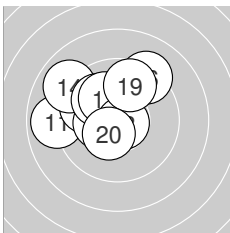

Serie 2:

8.9 ←	9.8 ↖	10.3 *	9.0 ↙	10.0 ↘
9.2 ↗	10.1 ↙	10.7 *	9.7 ↗	10.4 *

beste Teiler: 51.0 (18.), 136.4 (20.), 156.6 (13.)
 Trefferlage: 1.31 mm links, 1.24 mm hoch
 Streuwert: 1.99, horizontal: 2.30, vertikal: 1.63



Ergebnis: 134.5 (126)
Serien: 70.7 63.8
Zähler: 0 5 3 3 2 2 2 2 0 0
Innenzehner: 0
Weiteste: 2992 (15.), 1978 (17.), 1828 (13.)
beste Teiler: 335.9 (12.), 347.5 (3.), 349.5 (20.)
Trefferlage: 0.60 mm rechts, 5.37 mm hoch
Streuwert: 8.29, horizontal: 7.74, vertikal: 8.81

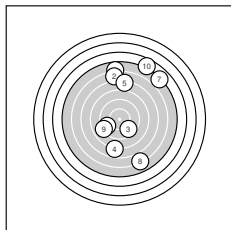
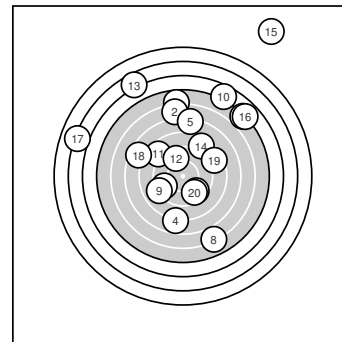

Serie 1:

5.7 ↑	6.4 ↑	9.6 ↘	7.8 ↓	7.1 ↑
9.5 ↙	5.0 ↗	6.0 ↘	9.0 ↙	4.6 ↗

beste Teiler: 347.5 (3.), 371.7 (6.), 490.6 (9.)
Trefferlage: 1.54 mm rechts, 3.27 mm hoch
Streuwert: 7.47, horizontal: 4.83, vertikal: 9.40

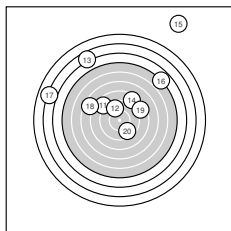

Serie 2:

8.6 ↘	9.6 ↖	3.6 ↖	8.5 ↗	0.0 ↗
4.9 ↗	3.0 ↙	7.5 ↘	8.5 ↗	9.6 ↘

beste Teiler: 335.9 (12.), 349.5 (20.), 584.8 (11.)
Trefferlage: 0.33 mm links, 7.48 mm hoch
Streuwert: 9.13, horizontal: 10.07, vertikal: 8.10



Ergebnis: **168.6** (159)
 Serien: 87.6 81.0
 Zähler: 2 7 5 4 0 0 2 0 0 0
 Innenzehner: 1
 Weitester: 1733 (13.), 1696 (3.), 986 (17.)
 beste Teiler: 41.1 (8.), 206.3 (14.), 304.2 (2.)
 Trefferlage: 1.98 mm links, 1.91 mm hoch
 Streuwert: 5.16, horizontal: 6.68, vertikal: 2.93

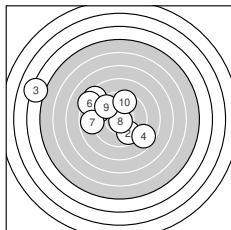
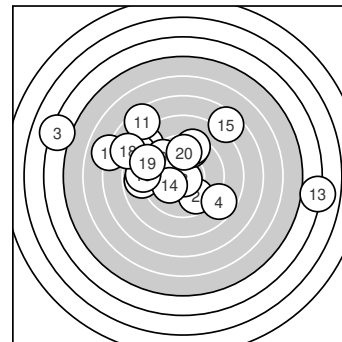

Serie 1:

8.5 ↘	9.7 ↘	4.2 ↖	8.7 ↘	9.2 ↖
8.4 ↖	8.9 ←	10.8 *	9.6 ↘	9.6 ↑

beste Teiler: 41.1 (8.), 304.2 (2.), 346.8 (10.)
 Trefferlage: 3.08 mm links, 1.33 mm hoch
 Streuwert: 4.52, horizontal: 5.69, vertikal: 2.90

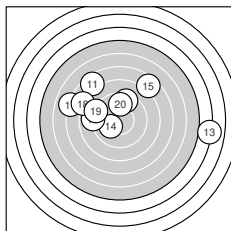

Serie 2:

7.5 ↘	9.4 ↑	4.0 →	10.1 ↖	7.5 ↗
8.9 ←	7.0 ↖	7.9 ↖	9.0 ↖	9.7 ↑

beste Teiler: 206.3 (14.), 304.3 (20.), 392.4 (12.)
 Trefferlage: 0.89 mm links, 2.49 mm hoch
 Streuwert: 5.84, horizontal: 7.69, vertikal: 3.00



Ergebnis: **175.8** (168)
 Serien: 86.8 89.0
 Zähler: 5 6 4 3 1 1 0 0 0 0
 Innenzehner: 3
 Weitester: 1356 (8.), 1103 (11.), 940 (9.)
 beste Teiler: 93.9 (3.), 116.1 (15.), 166.0 (1.)
 Trefferlage: 1.10 mm links, 0.28 mm tief
 Streuwert: 4.53, horizontal: 4.76, vertikal: 4.29

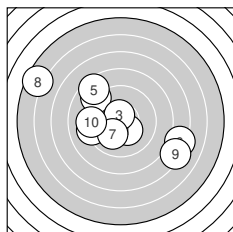
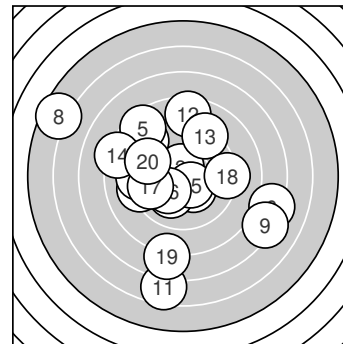

Serie 1:
 10.3 * 8.9 ↘ 10.6 * 9.2 ← 8.5 ↘
 7.3 → 10.1 ↙ 5.5 ↖ 7.2 ↘ 9.2 ←
 beste Teiler: 93.9 (3.), 166.0 (1.), 221.1 (7.)
 Trefferlage: 1.19 mm links, 0.26 mm hoch
 Streuwert: 5.01, horizontal: 6.19, vertikal: 3.47

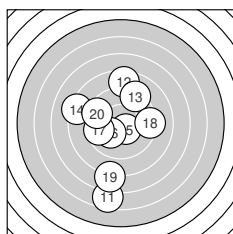

Serie 2:
 6.5 ↓ 8.5 ↑ 9.2 ↗ 8.2 ↖ 10.5 *
 10.1 ↙ 9.6 ← 9.2 → 7.7 ↓ 9.5 ↖
 beste Teiler: 116.1 (15.), 203.6 (16.), 334.6 (17.)
 Trefferlage: 1.02 mm links, 0.84 mm tief
 Streuwert: 4.23, horizontal: 3.09, vertikal: 5.12



Ergebnis: **161.5** (152)
 Serien: 79.2 82.3
 Zähler: 4 3 3 6 1 2 0 1 0 0
 Innenzehner: 3
 Weitester: 1781 (6.), 1279 (20.), 1266 (16.)
 beste Teiler: 8.9 (15.), 109.5 (18.), 187.4 (17.)
 Trefferlage: 0.25 mm rechts, 0.83 mm tief
 Streuwert: 6.04, horizontal: 7.76, vertikal: 3.55

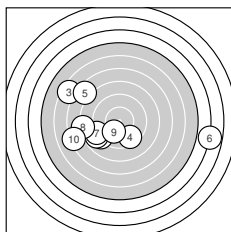
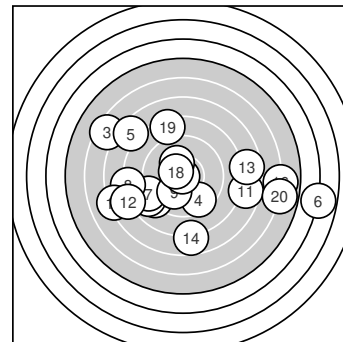

Serie 1:

9.0 ↙	8.8 ↙	6.4 ↘	9.5 ↘	7.5 ↘
3.8 →	9.0 ↙	8.1 ←	10.0 ↙	7.1 ←

beste Teiler: 229.2 (9.), 365.5 (4.), 477.1 (1.)
 Trefferlage: 2.67 mm links, 0.99 mm tief
 Streuwert: 6.14, horizontal: 7.93, vertikal: 3.54

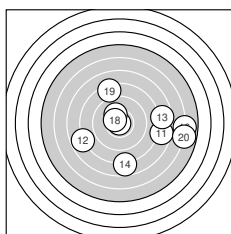

Serie 2:

7.6 →	7.8 ↙	7.6 →	7.7 ↓	10.9 *
5.9 →	10.2 *	10.5 *	8.3 ↑	5.8 →

beste Teiler: 8.9 (15.), 109.5 (18.), 187.4 (17.)
 Trefferlage: 3.17 mm rechts, 0.67 mm tief
 Streuwert: 5.45, horizontal: 6.74, vertikal: 3.75



Ergebnis: 188.9 (181)
Serien: 92.8 96.1
Zähler: 8 6 5 1 0 0 0 0 0 0
Innenzehner: 3
Weiteste: 776 (7.), 689 (1.), 645 (16.)
beste Teiler: 149.6 (6.), 173.3 (15.), 173.6 (8.)
Trefferlage: 0.67 mm rechts, 0.66 mm tief
Streuwert: 2.99, horizontal: 3.55, vertikal: 2.28

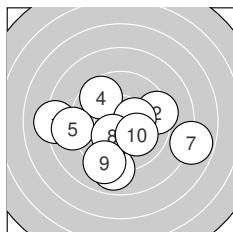
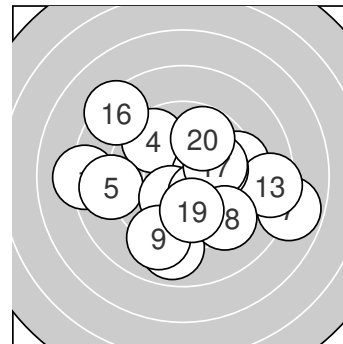

Serie 1:

8.2 ←	9.4 →	8.9 ↓	9.7 ↘	8.9 ←
10.4 *	7.8 →	10.3 *	9.1 ↓	10.1 ↘

beste Teiler: 149.6 (6.), 173.6 (8.), 219.4 (10.)
Trefferlage: 0.28 mm links, 1.17 mm tief
Streuwert: 3.35, horizontal: 4.15, vertikal: 2.28

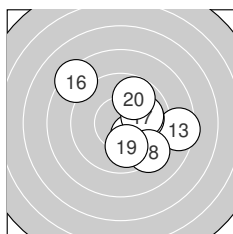

Serie 2:

10.1 ↘	9.7 →	8.5 →	10.0 →	10.3 *
8.4 ↘	10.0 →	9.3 ↘	10.0 ↓	9.8 ↗

beste Teiler: 173.3 (15.), 203.3 (11.), 237.6 (14.)
Trefferlage: 1.63 mm rechts, 0.14 mm tief
Streuwert: 2.50, horizontal: 2.71, vertikal: 2.29



Ergebnis: **172.7** (166)
Serien: 86.8 85.9
Zähler: 3 5 7 5 0 0 0 0 0 0
Innenzehner: 3
Weiteste: 973 (7.), 959 (5.), 944 (8.)
beste Teiler: 134.6 (2.), 151.0 (6.), 186.8 (15.)
Trefferlage: 0.00 mm , 1.54 mm tief
Streuwert: 4.44, horizontal: 5.29, vertikal: 3.38

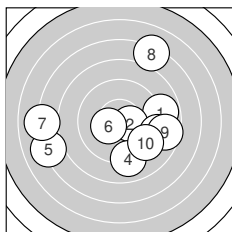
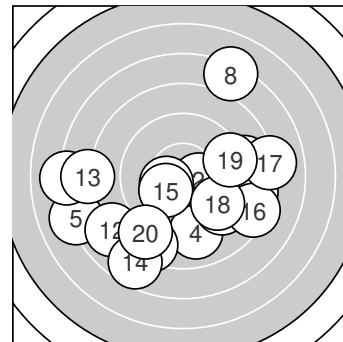

Serie 1:
 8.8 → 10.4 * 9.0 → 9.0 ↓ 7.1 ←
 10.3 * 7.1 ← 7.2 ↑ 8.6 → 9.3 ↘
beste Teiler: 134.6 (2.), 151.0 (6.), 421.3 (10.)
Trefferlage: 0.51 mm rechts, 0.49 mm tief
Streuwert: 4.73, horizontal: 5.63, vertikal: 3.62

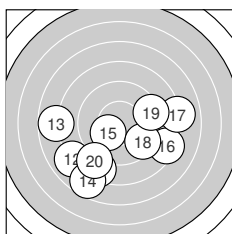

Serie 2:
 8.4 ↙ 8.0 ↖ 7.8 ← 7.7 ↙ 10.2 *
 8.3 ↘ 8.0 → 9.5 ↘ 9.3 → 8.7 ↙
beste Teiler: 186.8 (15.), 368.2 (18.), 416.8 (19.)
Trefferlage: 0.52 mm links, 2.59 mm tief
Streuwert: 4.21, horizontal: 5.19, vertikal: 2.93



Ergebnis: **164.5** (156)
 Serien: 83.8 80.7
 Zähler: 1 7 4 4 3 1 0 0 0 0
 Innenzehner: 0
 Weitestе: 1405 (20.), 1054 (13.), 1033 (9.)
 beste Teiler: 247.7 (11.), 292.1 (10.), 292.6 (7.)
 Trefferlage: 1.29 mm links, 1.16 mm hoch
 Streuwert: 5.30, horizontal: 6.43, vertikal: 3.85

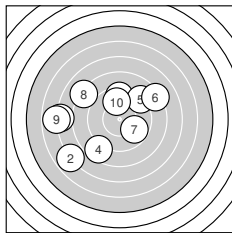
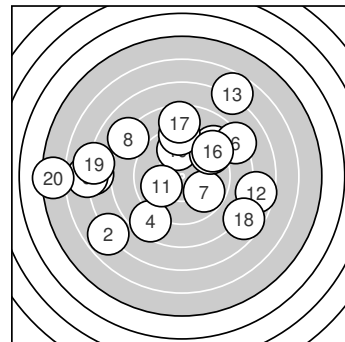

Serie 1:

7.1 ←	6.9 ↙	9.4 ↑	8.6 ↘	9.1 ↗
8.2 ↗	9.8 ↘	8.1 ↖	6.8 ←	9.8 ↑

beste Teiler: 292.1 (10.), 292.6 (7.), 382.0 (3.)
 Trefferlage: 2.62 mm links, 0.49 mm hoch
 Streuwert: 4.85, horizontal: 5.73, vertikal: 3.77

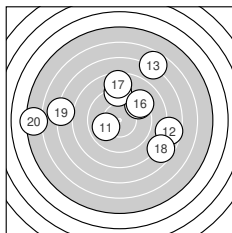

Serie 2:

10.0 ↙	7.6 →	6.7 ↗	9.4 ↗	9.1 ↑
9.2 ↗	8.6 ↑	7.7 ↘	7.1 ←	5.3 ←

beste Teiler: 247.7 (11.), 394.8 (14.), 430.7 (16.)
 Trefferlage: 0.02 mm rechts, 1.83 mm hoch
 Streuwert: 5.78, horizontal: 7.12, vertikal: 4.00



Ergebnis: **136.8** (126)
 Serien: 73.6 63.2
 Zähler: 0 2 7 2 0 3 5 1 0 0
 Innenzehner: 0
 Weitester: 1866 (20.), 1634 (8.), 1592 (1.)
 beste Teiler: 296.0 (9.), 497.3 (10.), 516.2 (4.)
 Trefferlage: 2.86 mm links, 1.32 mm hoch
 Streuwert: 7.93, horizontal: 8.23, vertikal: 7.61

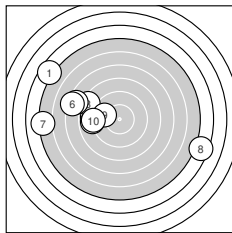
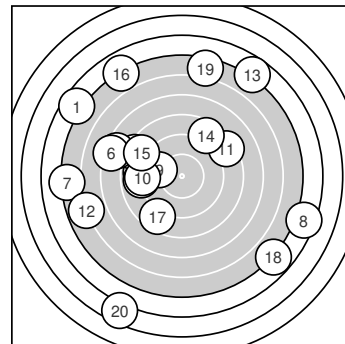

Serie 1:

4.6 ↘	8.9 ←	8.3 ↖	8.9 ←	7.4 ↖
7.2 ↖	5.1 ←	4.4 →	9.8 ↖	9.0 ←

beste Teiler: 296.0 (9.), 497.3 (10.), 516.2 (4.)
 Trefferlage: 5.35 mm links, 1.21 mm hoch
 Streuwert: 6.35, horizontal: 8.19, vertikal: 3.70

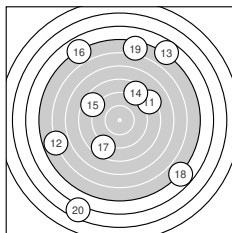

Serie 2:

8.3 ↗	5.8 ←	4.7 ↗	8.6 ↗	8.6 ↖
4.9 ↘	8.6 ↙	4.8 ↘	5.4 ↑	3.5 ↙

beste Teiler: 587.8 (15.), 593.7 (17.), 595.1 (14.)
 Trefferlage: 0.37 mm links, 1.43 mm hoch
 Streuwert: 9.24, horizontal: 7.89, vertikal: 10.42



Ergebnis: **154.4** (145)
 Serien: 79.6 74.8
 Zähler: 0 5 6 3 2 3 1 0 0 0
 Innenzehner: 0
 Weitester: 1720 (14.), 1405 (17.), 1309 (12.)
 beste Teiler: 283.1 (3.), 333.4 (9.), 346.0 (13.)
 Trefferlage: 6.17 mm links, 2.80 mm hoch
 Streuwert: 4.31, horizontal: 4.83, vertikal: 3.72

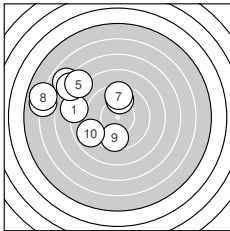
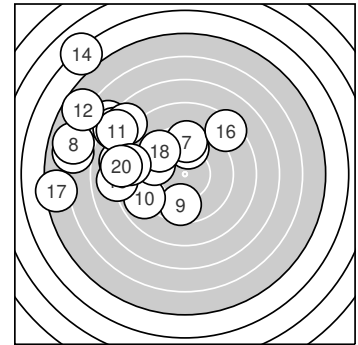

Serie 1:

8.1 ←	6.9 ↘	9.8 ↑	7.3 ↘	7.6 ↘
6.0 ←	9.5 ↑	5.9 ←	9.6 ↓	8.9 ↙

beste Teiler: 283.1 (3.), 333.4 (9.), 353.4 (7.)
 Trefferlage: 5.80 mm links, 2.37 mm hoch
 Streuwert: 3.96, horizontal: 4.66, vertikal: 3.12

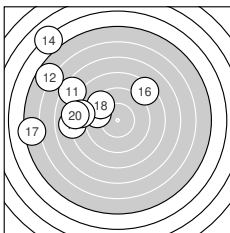

Serie 2:

7.5 ↘	5.7 ↘	9.6 ←	4.1 ↘	8.0 ←
8.4 ↗	5.3 ←	9.5 ↘	8.5 ←	8.2 ←

beste Teiler: 346.0 (13.), 371.6 (18.), 602.8 (19.)
 Trefferlage: 6.54 mm links, 3.24 mm hoch
 Streuwert: 4.80, horizontal: 5.21, vertikal: 4.36



25m Pist. Auflage – Wertung Seniores I männl.

StartNr: 403

StandNr: 143

4. August 2006 2:31

Albers, Peter #348

5000 PolSV Dortmund

Ergebnis: **287** 287 Serien: 48 49 46 48 48 48
 Zähler: 19 9 2 0 0 0 Innenzehner: 12

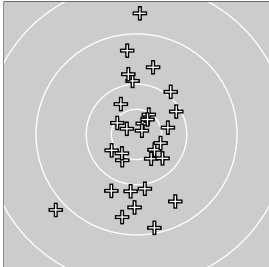

Auflage Wertung

Serie 1:	10.7 * [-1537586.83]	10.0 ↑ [-1537561.27]	9.8 ↓ [-1537538.23]	9.4 ↓ [-1537509.36]	9.5 * [-1537483.70]
Serie 2:	10.4 * [-1537584.72]	10.8 * [-1537557.96]	10.4 * [-1537528.02]	10.4 → [-1537503.52]	9.6 ↓ [-1537477.00]
Serie 3:	8.9 ↘ [-1537579.64]	9.7 ↑ [-1537551.29]	9.1 ↗ [-1537523.88]	8.4 * [-1537498.95]	9.5 ↘ [-1537477.25]
Serie 4:	8.7 ↑ [-1537584.01]	10.3 ↘ [-1537555.12]	10.0 ↓ [-1537536.57]	9.5 * [-1537490.18]	9.5 * [-1537477.07]
Serie 5:	9.4 ↑ [-1537583.40]	10.5 * [-1537550.07]	9.9 ↓ [-1537532.75]	9.3 ↖ [-1537500.06]	9.6 * [-1537475.96]
Serie 6:	9.2 ↓ [-1537586.87]	9.9 ↑ [-1537560.91]	10.8 * [-1537534.05]	10.0 ↗ [-1537515.08]	9.5 * [-1537497.75]



25m Pist. Auflage – Wertung **Senioren I männl.**

StartNr: 404

StandNr: 142

19. Juni 2022 9:50

Nolte, Manfred #345

5000 PolSV Dortmund

Ergebnis: **277** 277 Serien: 43 48 44 46 49 47
 Zähler: 11 15 4 0 0 0 Innenzehner: 2

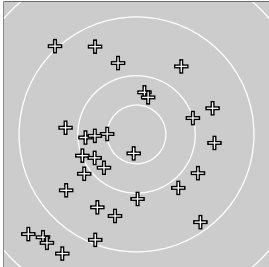

Auflage Wertung

Serie 1:	9.7 ↘ [16.16]	8.7 ↘ [22.95]	9.8 ← [36.04]	8.6 ↘ [45.48]	9.9 ↘ [60.22]
Serie 2:	8.7 ↘ [18.97]	10.1 ← [36.32]	10.2 ← [43.66]	10.7 * [48.81]	10.2 ↘ [56.40]
Serie 3:	9.2 ↘ [14.77]	8.7 ↘ [22.59]	9.1 ↘ [31.78]	9.7 ↗ [41.14]	9.7 → [48.79]
Serie 4:	10.5 * [18.47]	9.8 ↑ [26.94]	9.9 ↘ [35.80]	9.6 ↓ [48.63]	9.8 ↘ [56.01]
Serie 5:	10.3 ↑ [16.61]	10.0 ↓ [28.47]	10.3 ← [39.02]	9.7 → [46.37]	10.1 → [55.56]
Serie 6:	10.2 ↘ [18.86]	9.0 ↘ [27.80]	10.4 ↑ [37.58]	9.4 ↘ [53.21]	9.5 ↘ [62.31]

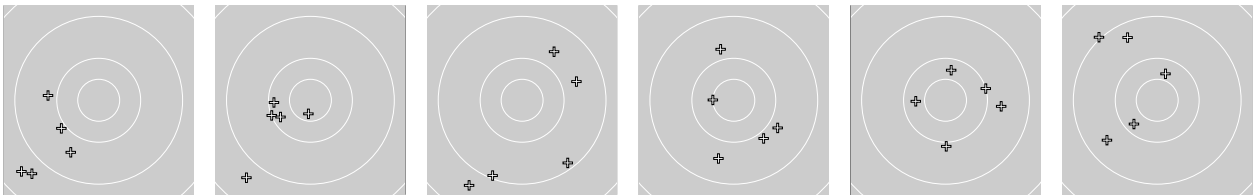

25m Pist. Auflage – Wertung Senioren III männl.

StartNr: 415

StandNr: 147

19. Juni 2022 9:51

Denzel, Rolf #356

5000 PolSV Dortmund / PolSV Dortmund

Ergebnis: **273** 273 Serien: 47 44 47 45 45 45
 Zähler: 7 19 4 0 0 0 Innenzehner: 2

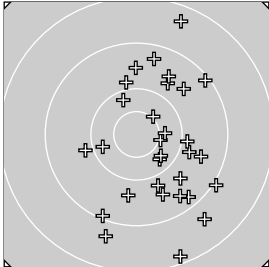

Auflage Wertung

Serie 1:	10.3 ↘ [22.84]	9.1 ↓ [43.25]	9.9 ← [61.58]	10.5 * [81.50]	9.3 ↘ [94.43]
Serie 2:	9.8 ↘ [38.11]	8.2 ↘ [59.28]	9.7 ↓ [78.34]	9.6 ↘ [104.58]	9.7 ↘ [123.27]
Serie 3:	10.2 ← [18.49]	9.6 ↑ [37.34]	9.0 ↘ [59.10]	9.6 ↘ [89.10]	10.5 * [106.84]
Serie 4:	9.8 ↗ [23.99]	9.1 ↗ [45.52]	8.7 ↘ [73.77]	9.6 ↗ [100.34]	10.3 ↘ [121.83]
Serie 5:	9.9 ↑ [21.24]	9.8 ↘ [43.84]	9.9 → [67.92]	9.4 ↘ [91.73]	9.4 ↑ [112.85]
Serie 6:	9.6 ↗ [20.66]	8.7 ↓ [45.78]	10.2 ↗ [64.87]	10.4 → [83.75]	8.4 ↑ [108.31]

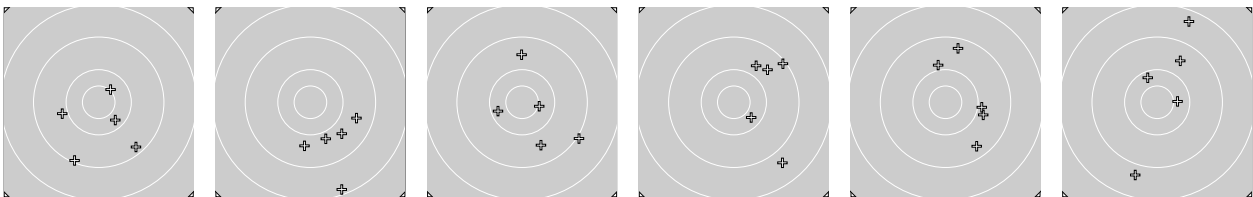

25m Pist. Auflage – Wertung Senioren IV männl.

StartNr: 417

StandNr: 149

19. Juni 2022 9:51

Latzel, Wilfried / Schießgruppe Overberge 1960 e. / Schießgruppe Overberge 1960 e. V.

Ergebnis: **265** 265 Serien: 42 41 42 45 46 49
 Zähler: 10 10 6 3 1 0 Innenzehner: 2

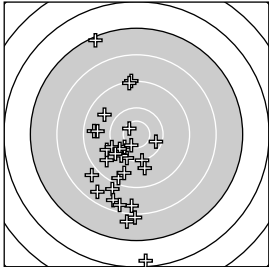

Auflage Wertung

Serie 1:	9.5 ← [7.95]	10.1 ↓ [33.27]	7.9 ↓ [50.90]	8.8 ↓ [71.78]	8.4 ↓ [97.10]
Serie 2:	9.6 ↘ [7.34]	8.8 ↗ [30.13]	7.8 ↓ [50.20]	9.3 ↓ [67.96]	8.4 ↓ [88.19]
Serie 3:	7.2 ↑ [9.67]	8.4 ↗ [28.96]	9.6 ↗ [48.54]	9.8 ← [72.77]	9.5 ↓ [95.54]
Serie 4:	6.3 ↓ [13.74]	10.1 ↓ [33.57]	9.6 ← [56.85]	10.2 ↘ [83.14]	10.0 ← [106.86]
Serie 5:	9.0 ↑ [11.06]	10.1 ↗ [28.93]	10.6 * [49.02]	8.3 ↓ [71.51]	9.1 ↑ [89.79]
Serie 6:	10.4 ↗ [12.98]	10.2 ↗ [38.05]	9.8 ↓ [64.71]	10.5 * [91.39]	10.0 ↗ [117.93]

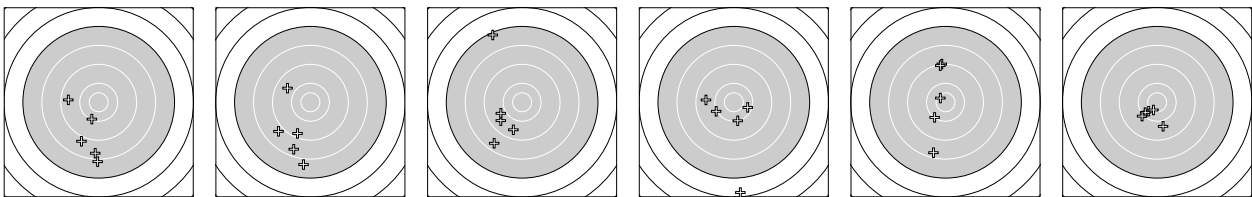

25m Pist. Auflage – Wertung Senioren V männl.

StartNr: 418

StandNr: 150

19. Juni 2022 9:51

Rotenburger Schießgruppe Overberge 1960 e. / Schießgruppe Overberge 1960 e. V.

Ergebnis: **276** 276 Serien: 42 45 46 50 47 46
 Zähler: 12 12 6 0 0 0 Innenzehner: 3

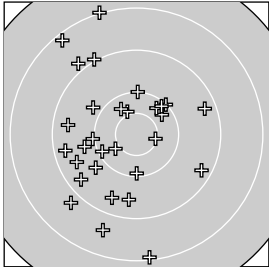

Auflage Wertung

Serie 1:	8.9 ↘ [10.48]	8.0 ↑ [28.23]	9.0 ↘ [46.97]	8.8 ↙ [79.70]	9.5 ← [83.26]
Serie 2:	9.3 → [36.91]	10.4 * [59.29]	8.1 ↓ [104.57]	10.1 ↓ [108.53]	8.7 ↓ [112.79]
Serie 3:	9.4 ← [41.46]	9.8 ↗ [57.85]	9.4 ↘ [84.31]	10.1 ↗ [105.08]	9.5 ↓ [131.81]
Serie 4:	10.0 ← [15.09]	10.3 ↗ [39.27]	10.2 ↗ [63.46]	10.1 ↗ [87.29]	10.5 * [109.03]
Serie 5:	9.3 ↘ [34.76]	9.8 ← [51.79]	10.0 ↑ [70.01]	10.1 ← [92.95]	9.8 ↘ [117.00]
Serie 6:	9.4 ↗ [39.65]	8.2 ↘ [58.75]	10.4 * [83.01]	9.3 ← [120.07]	10.3 ↘ [125.63]

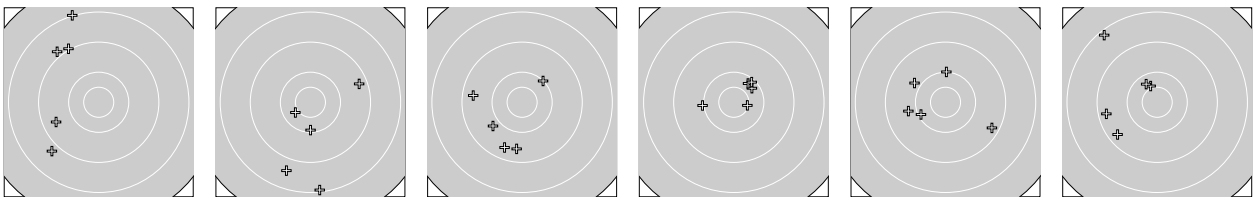

25m Pist. Auflage – Wertung Senioren III männl.

StartNr: 419

StandNr: 148

19. Juni 2022 9:50

Schießclub Herbergschützengruppe Overberge 1960 e. / Schießgruppe Overberge 1960 e. V.

Ergebnis: **288** 288 Serien: 48 49 47 48 48 48
 Zähler: 21 6 3 0 0 0 Innenzehner: 10

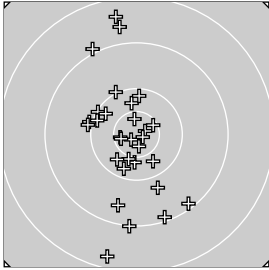

Auflage Wertung

Serie 1:	10.1 ↖ [9.04]	10.8 * [29.63]	10.8 * [55.60]	10.4 * [74.83]	8.3 ↓ [95.91]
Serie 2:	10.0 ↖ [7.47]	9.5 ↓ [28.03]	10.2 ↖ [51.03]	10.0 ↖ [75.31]	10.2 ↓ [97.09]
Serie 3:	10.6 * [6.70]	8.7 ↑ [25.47]	9.2 ↓ [48.03]	10.4 * [68.58]	10.0 ↖ [113.11]
Serie 4:	9.0 ↖ [7.89]	10.6 * [28.56]	10.8 * [51.22]	10.6 * [73.91]	9.2 ↓ [100.66]
Serie 5:	10.6 * [4.34]	8.5 ↑ [26.79]	10.7 * [47.10]	10.3 ↑ [70.15]	10.3 ↓ [116.65]
Serie 6:	10.1 ↖ [5.93]	10.2 ↑ [24.93]	10.3 ↗ [53.46]	9.8 ↓ [72.69]	9.1 ↓ [93.44]

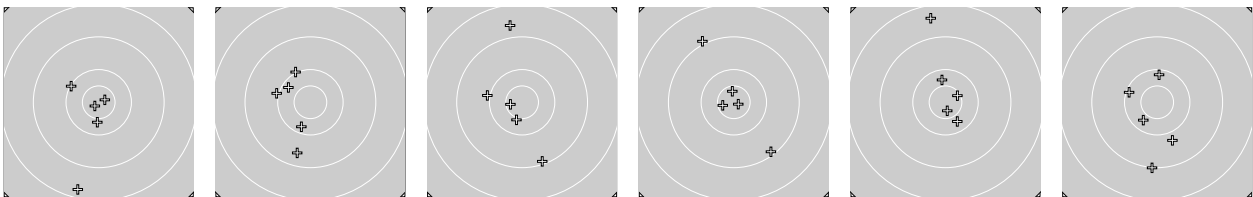

25m Pist. Auflage – Wertung Senioren IV männl.

StartNr: 443

StandNr: 145

19. Juni 2022 9:50

Noy, Hans-Peter Bürgerschützengilde Westerhol / Bürgerschützengilde Westerholt 158

Ergebnis: **279** 279 Serien: 45 46 48 46 47 47
 Zähler: 9 21 0 0 0 0 Innenzehner: 3

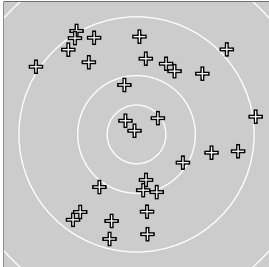

Auflage Wertung

Serie 1:	9.5 ↗ [11.12]	9.2 ↘ [21.49]	9.0 ↗ [37.64]	9.8 ↗ [42.79]	9.0 ↘ [45.79]
Serie 2:	9.8 ↑ [13.73]	10.1 ↓ [40.28]	9.3 ↘ [49.03]	9.7 ↓ [54.34]	9.7 → [63.11]
Serie 3:	10.9 * [14.62]	9.2 ↓ [31.68]	10.5 * [50.13]	10.0 ↘ [64.92]	9.3 ↗ [83.22]
Serie 4:	9.8 ↗ [22.37]	9.4 ↗ [34.80]	10.2 ↓ [51.24]	9.0 ↘ [63.80]	9.1 ↘ [74.74]
Serie 5:	9.0 → [16.45]	9.4 ↑ [61.60]	10.2 ↗ [71.27]	10.0 ↗ [86.22]	9.6 ↘ [107.90]
Serie 6:	10.7 * [9.84]	9.4 ↓ [25.12]	9.3 → [40.65]	9.5 ↓ [49.11]	10.1 ↘ [62.52]

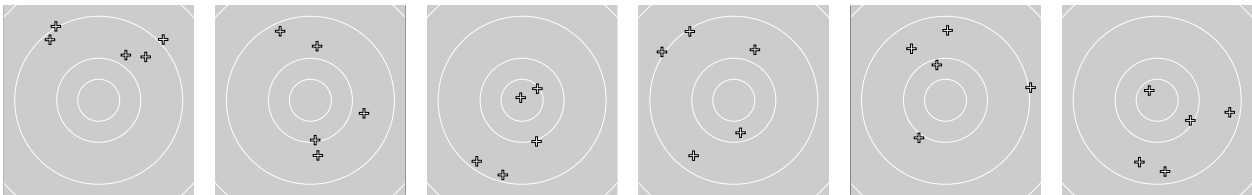

25m Pist. Auflage – Wertung Senioren IV männl.

StartNr: 444

StandNr: 146

19. Juni 2022 9:50

Stolte, Siegfried Schützengilde Westerhol / Bürgerschützengilde Westerholt 158

Ergebnis: **216** 216 Serien: 32 35 40 41 29 39
 Zähler: 1 6 9 8 1 2 Innenzehner: 1

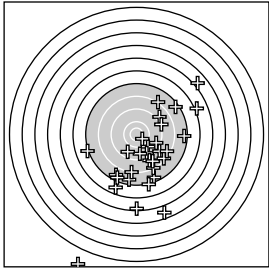

Auflage Wertung

Serie 1:	7.4 ↘ [18.26]	4.5 ↘ [32.30]	7.5 ↙ [49.16]	9.7 ↘ [60.14]	5.2 ↓ [68.84]
Serie 2:	9.4 ↘ [16.90]	8.1 ↘ [31.64]	7.5 ↓ [54.70]	7.0 ← [71.27]	4.8 ↗ [81.77]
Serie 3:	8.8 ↘ [17.06]	8.0 ↗ [30.76]	8.2 ↘ [44.61]	7.3 ↗ [58.98]	9.4 ↘ [71.91]
Serie 4:	10.4 * [15.23]	7.3 → [44.83]	8.8 ↘ [63.99]	8.6 ↘ [80.45]	8.1 ↓ [95.88]
Serie 5:	6.6 ↓ [20.84]	0.0 ↓ [35.16]	7.0 ↓ [44.85]	7.3 ↙ [60.59]	9.5 ↓ [65.23]
Serie 6:	5.9 → [15.10]	8.8 ↗ [28.83]	9.0 → [47.33]	9.5 ↙ [63.48]	8.3 ↘ [99.60]

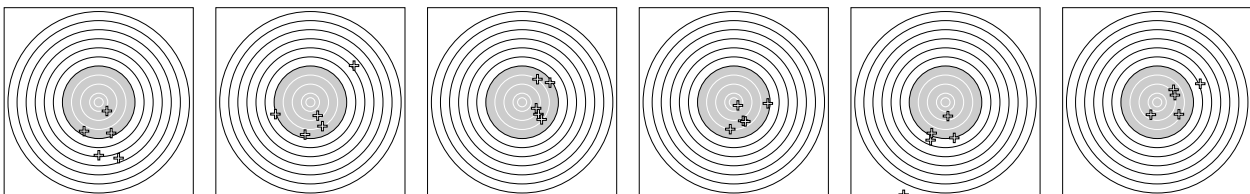

25m Pist. Auflage – Wertung – Herren I

StartNr: 372

StandNr: 149

19. Juni 2022 10:49

Neise, Klaus #403

5000 SSC Soest-Süd e.V.

Ergebnis: **277** 277 Serien: 46 44 44 49 46 48
Zähler: 10 17 3 0 0 0 Innenzehner: 4

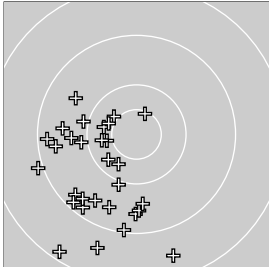

Auflage Wertung

Serie 1:	9.5 ↓ [20.58]	9.6 ← [59.18]	9.2 ↗ [96.06]	9.1 ↓ [113.77]	10.3 ↖ [130.35]
Serie 2:	9.0 ← [12.63]	9.3 ↖ [41.58]	8.2 ↗ [75.27]	9.4 ↖ [101.97]	9.7 ← [124.43]
Serie 3:	9.5 ↗ [13.17]	9.3 ← [40.28]	9.6 ↖ [74.55]	8.5 ↓ [103.63]	9.9 ← [128.70]
Serie 4:	10.0 ↓ [19.20]	10.4 * [53.33]	9.5 ↓ [77.55]	10.3 ↖ [100.97]	10.4 * [125.02]
Serie 5:	8.6 ↓ [14.04]	10.0 ← [45.49]	9.2 ↗ [76.78]	9.5 ↓ [99.59]	10.5 * [122.96]
Serie 6:	10.3 ← [18.67]	10.3 ← [49.04]	9.4 ← [77.14]	10.4 * [100.13]	9.7 ↓ [122.07]

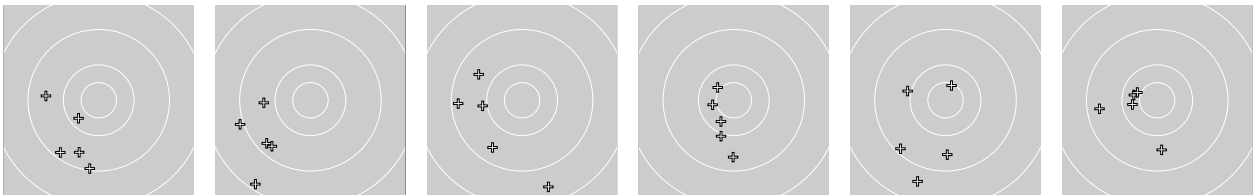

25m Pist. Auflage – Wertung – Herren I

StartNr: 373

StandNr: 150

19. Juni 2022 10:48

Müller, Rita #404

5000 SSC Soest–Süd e.V.

Ergebnis: **273** 273 Serien: 43 47 46 45 45 47
 Zähler: 11 13 5 0 1 0 Innenzehner: 3

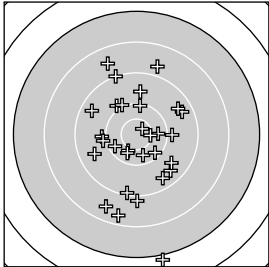

Auflage Wertung

Serie 1:	9.6 ↙ [13.43]	8.9 ↓ [31.52]	8.5 ↘ [53.99]	8.6 ↖ [74.58]	10.2 ↙ [118.52]
Serie 2:	10.3 ↘ [15.18]	9.9 ↖ [29.93]	10.7 * [63.55]	9.4 ↗ [74.92]	9.4 ↘ [95.19]
Serie 3:	10.4 * [9.53]	9.9 → [27.46]	10.1 ↑ [46.37]	8.8 ↑ [57.82]	9.1 ↖ [79.35]
Serie 4:	9.4 ↘ [33.57]	9.9 ← [47.63]	10.0 ↖ [62.12]	9.1 ↓ [75.80]	8.4 ↓ [99.07]
Serie 5:	9.7 ↑ [18.11]	10.3 → [48.26]	10.0 ← [72.68]	6.9 ↓ [85.45]	10.3 ↘ [95.04]
Serie 6:	9.4 ↖ [17.23]	9.5 ↗ [32.61]	9.6 ↘ [51.79]	10.2 ↘ [77.86]	10.5 * [89.50]

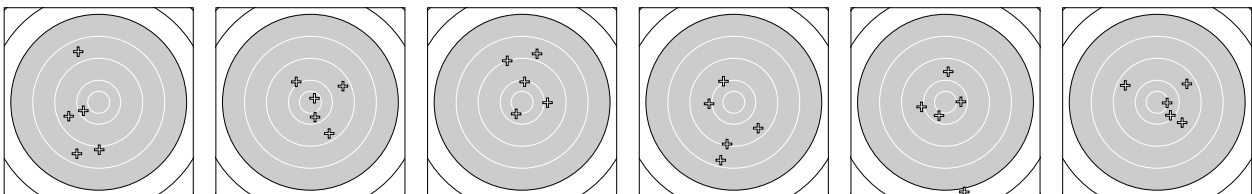

25m Pist. Auflage – Wertung Seniores I männl.

StartNr: 385

StandNr: 146

19. Juni 2022 10:48

König, Franz #392

5000 KKS SV Geseke e.V. / KKS SV Geseke e.V.

Ergebnis: **276** 276 Serien: 44 48 44 46 47 47
 Zähler: 12 13 4 1 0 0 Innenzehner: 7

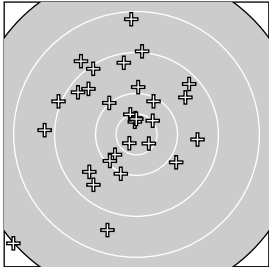

Auflage Wertung

Serie 1:	10.7 * [7.68]	8.8 ↘ [19.70]	8.6 ↓ [31.74]	8.2 ↑ [45.21]	10.7 * [59.37]
Serie 2:	10.0 ↓ [2.60]	10.6 * [12.46]	9.1 ↘ [24.80]	10.0 ↘ [50.75]	9.3 ↗ [62.36]
Serie 3:	9.4 ↘ [3.26]	9.6 ↙ [13.92]	9.3 ↘ [25.44]	10.3 ↙ [36.38]	7.0 ↙ [62.48]
Serie 4:	10.6 * [4.62]	9.9 ↑ [17.92]	9.6 ↗ [31.82]	9.4 ↙ [42.92]	9.6 → [58.83]
Serie 5:	9.0 ↑ [2.19]	8.8 ← [13.67]	10.5 * [26.72]	10.1 ↑ [38.94]	10.1 ↙ [51.94]
Serie 6:	9.3 ↑ [3.98]	10.6 * [15.53]	9.0 ↘ [41.14]	9.9 ↘ [83.69]	10.5 * [94.09]

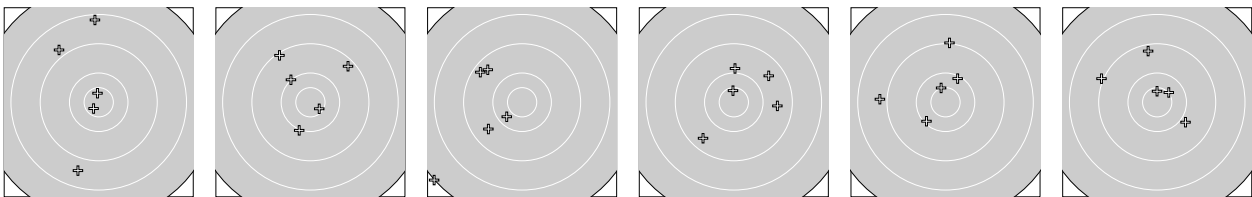

25m Pist. Auflage – Wertung Seniores I männl.

StartNr: 387

StandNr: 148

19. Juni 2022 10:48

Wunderlich, Leo #395

5000 KKS SV Geseke e.V. / KKS SV Geseke e.V.

Ergebnis: **268** 268 Serien: 35 44 46 49 47 47
 Zähler: 13 10 6 0 0 0 Innenzehner: 6

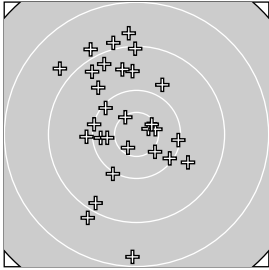

Auflage Wertung

Serie 1:	8.8 ↘ [19.08]	9.3 ↘ [32.30]	8.8 ↑ [47.14]	10.2 ← [60.76]	0.0 [0.00]
Serie 2:	8.9 ↑ [5.74]	9.6 ↑ [23.35]	8.9 ↘ [45.83]	9.1 ↑ [66.00]	10.7 * [87.64] ^{PAD}
Serie 3:	8.9 ↘ [5.29]	10.6 * [21.51]	9.6 ↑ [42.11]	9.2 ↘ [63.10]	10.6 * [90.73]
Serie 4:	10.1 ↘ [8.06]	9.7 ↘ [27.93]	10.1 ← [45.38]	10.5 * [69.90]	10.3 ← [90.07]
Serie 5:	10.6 * [5.81]	9.3 ↘ [23.82]	10.4 * [45.38]	9.8 ↑ [66.62]	9.7 ↘ [90.47]
Serie 6:	10.1 ↘ [9.88]	10.0 ↘ [25.50]	10.1 → [51.10]	9.9 ← [73.01]	8.3 ↓ [92.25]

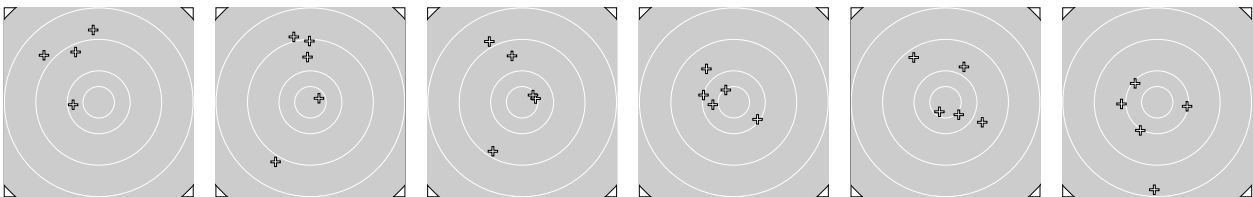

PAD – Treffer wurde erzeugt um eine unvollständige Serie aufzufüllen



25m Pist. Auflage – Wertung Seniores I männl.

StartNr: 391

StandNr: 143

4. August 2006 4:28

Göbel, Angelika #261 WF Hagener Bürgerschützen e.V. / Hagener Bürgerschützen e.V.

Ergebnis: **285** 285 Serien: 45 47 50 46 49 48
 Zähler: 18 9 3 0 0 0 Innenzehner: 5

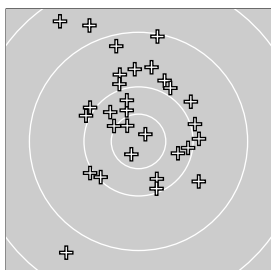

Auflage Wertung

Serie 1:	8.4 ↘ [-1537575.88]	8.3 ↑ [-1537559.28]	8.8 ↑ [-1537545.98]	8.8 ↑ [-1537536.33]	8.0 ↘ [-1537521.99]
Serie 2:	10.6 * [-1537584.54]	9.7 ↑ [-1537573.11]	10.0 ↘ [-1537554.24]	9.7 ↑ [-1537541.89]	9.1 ↑ [-1537532.74]
Serie 3:	10.8 * [-1537588.48]	8.3 ↘ [-1537573.21]	10.3 ↘ [-1537554.21]	10.1 ↘ [-1537540.65]	8.3 ↘ [-1537520.81]
Serie 4:	10.5 * [-1537582.38]	8.8 ↘ [-1537567.92]	8.6 ↘ [-1537538.42]	10.0 ↘ [-1537530.22]	10.1 → [-1537509.26]
Serie 5:	9.9 ↗ [-1537582.94]	10.1 ↗ [-1537558.59]	9.7 * [-1537539.28]	10.0 ↑ [-1537530.81]	10.4 * [-1537514.00]
Serie 6:	9.7 ↘ [-1537586.07]	9.9 ↗ [-1537563.86]	10.0 → [-1537546.06]	10.2 ↑ [-1537526.61]	10.0 → [-1537513.41]



25m Pist. Auflage – Wertung Seniores I männl.

StartNr: 392

StandNr: 142

19. Juni 2022 11:48

Göbel, Elmar #260WF Hagener Bürgerschützen e.V. / Hagener Bürgerschützen e.V.

Ergebnis: **283** 283 Serien: 47 47 49 46 45 49
 Zähler: 16 11 3 0 0 0 Innenzehner: 7

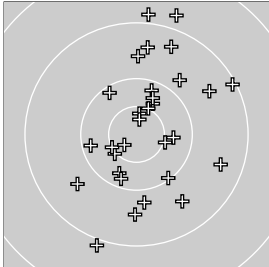

Auflage Wertung

Serie 1:	9.4 ↗ [8.85]	8.9 ↑ [20.30]	10.2 ↘ [31.34]	10.4 ↗ [68.67]	10.5 * [80.21]
Serie 2:	9.1 ↗ [15.07]	10.2 ← [34.38]	9.7 ↘ [55.27]	10.1 ↘ [71.11]	9.8 ↓ [84.36]
Serie 3:	10.4 → [11.78]	9.5 ↘ [45.91]	10.5 * [64.63]	10.5 * [81.01]	10.6 * [97.08]
Serie 4:	9.5 ↗ [28.50]	9.6 ↓ [43.23]	9.6 ↘ [80.86]	10.2 ↑ [93.39]	9.8 ↗ [109.49]
Serie 5:	8.8 ↑ [9.89]	8.9 ↓ [35.05]	10.3 ↑ [62.82]	10.5 * [73.87]	9.5 ↑ [90.37]
Serie 6:	9.7 ↑ [12.18]	10.7 * [27.47]	10.7 * [70.16]	10.3 ↓ [83.49]	10.2 ↓ [96.81]



25m Pist. Auflage – Wertung Seniores I männl.

StartNr: 393

StandNr: 141

19. Juni 2022 11:48

Letzing, Jochen #265 Hagener Bürgerschützen e.V. / Hagener Bürgerschützen e.V.

Ergebnis: **274** 274 Serien: 47 44 46 46 42 49
 Zähler: 13 13 1 1 2 0 Innenzehner: 5

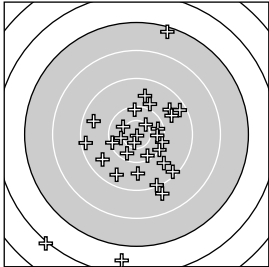

Auflage Wertung

Serie 1:	9.1 ↘ [11.40]	10.2 ↘ [18.94]	10.3 ↙ [35.00]	9.7 ↑ [45.74]	9.5 ↙ [52.03]
Serie 2:	9.5 ↖ [6.03]	10.5 * [18.88]	10.2 ↑ [28.07]	6.5 ↓ [38.42]	9.9 ↑ [47.95]
Serie 3:	10.5 * [13.89]	9.2 ↘ [25.56]	10.1 ↘ [42.75]	8.8 ↘ [56.77]	9.6 ↗ [71.28]
Serie 4:	9.2 ← [16.52]	9.7 ↓ [42.30]	9.3 ↗ [52.85]	9.6 ↘ [68.49]	10.1 ↘ [81.00]
Serie 5:	6.0 ↗ [14.56]	7.2 ↑ [29.72]	9.6 ↗ [41.96]	10.4 * [63.41]	10.2 → [81.94]
Serie 6:	9.6 ↗ [16.65]	10.1 ← [33.52]	10.9 * [54.18]	10.3 → [93.43]	10.7 * [104.96]

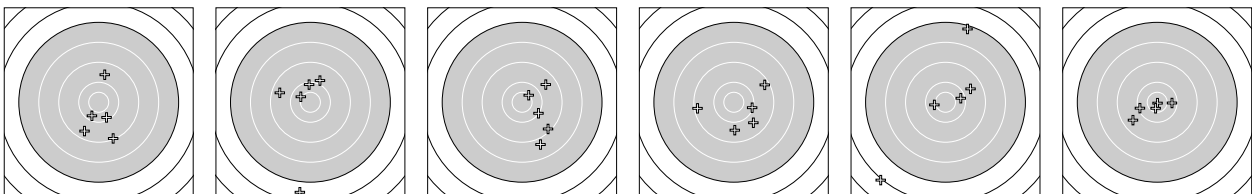

25m Pist. Auflage – Wertung Seniores I männl.

StartNr: 394

StandNr: 147

19. Juni 2022 11:47

Limpert, Andreas #300

WF KKS SV Gevelsberg e.V. / KKS SV Gevelsberg e.V.

Ergebnis: **257** 257 Serien: 47 43 39 42 44 42
 Zähler: 4 14 9 1 2 0 Innenzehner: 1

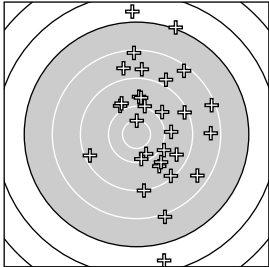

Auflage Wertung

Serie 1:	9.2 ↙ [8.94]	9.9 ↘ [15.75]	9.9 ↗ [22.63]	10.0 ↑ [28.47]	10.3 ↓ [33.75]
Serie 2:	10.1 ↓ [8.96]	6.5 ↓ [16.50]	10.5 * [23.68]	9.0 ↓ [31.11]	8.2 → [37.61]
Serie 3:	8.7 ↑ [10.24]	8.9 ↗ [18.67]	6.7 ↑ [25.96]	8.2 ↑ [33.50]	9.7 ↑ [40.36]
Serie 4:	8.4 → [18.70]	9.8 → [29.55]	9.7 ↓ [35.61]	9.5 ↘ [42.82]	7.0 ↑ [50.35]
Serie 5:	9.8 ↘ [9.99]	9.9 ↘ [18.50]	9.2 → [24.18]	8.4 ↘ [32.99]	9.7 ↓ [39.48]
Serie 6:	8.7 ↑ [16.61]	8.2 ↗ [25.94]	8.0 ↓ [37.50]	9.7 ↑ [42.07]	9.1 ↓ [48.90]

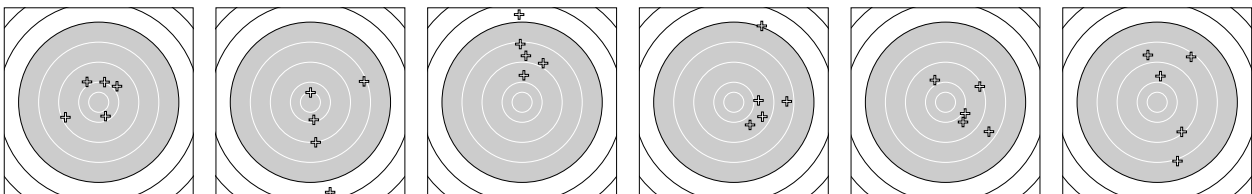

25m Pist. Auflage – Wertung Seniores I männl.

StartNr: 395

StandNr: 146

19. Juni 2022 11:48

Niggeloh, Volker #299

WF KKS SV Gevelsberg e.V. / KKS SV Gevelsberg e.V.

Ergebnis: **273** 273 Serien: 43 47 45 46 44 48
 Zähler: 15 8 4 1 2 0 Innenzehner: 6

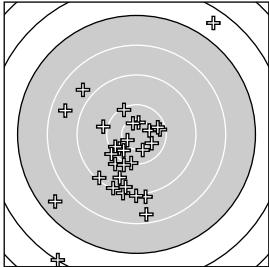

Auflage Wertung

Serie 1:	10.1 ↓ [12.28]	10.4 * [23.81]	9.8 ↗ [37.29]	8.5 ↖ [46.59]	6.1 ↘ [55.09]
Serie 2:	10.3 ↗ [15.89]	9.9 ↖ [27.84]	9.1 ↘ [43.18]	9.1 ↗ [56.19]	10.6 * [70.29]
Serie 3:	10.2 ↖ [16.33]	9.0 ↓ [26.28]	10.5 * [40.22]	8.9 ↓ [50.35]	8.7 ↖ [67.12]
Serie 4:	7.5 ↗ [19.37]	10.3 ↘ [29.34]	10.1 ↖ [40.34]	10.4 * [55.97]	9.5 ↓ [70.56]
Serie 5:	6.5 ↖ [18.55]	8.4 ↓ [32.20]	10.6 * [39.98]	10.0 ↘ [47.13]	10.0 ↗ [62.90]
Serie 6:	10.6 * [16.54]	9.0 ↓ [25.02]	9.3 ↓ [40.26]	10.2 ↗ [53.59]	10.3 ↘ [81.71]

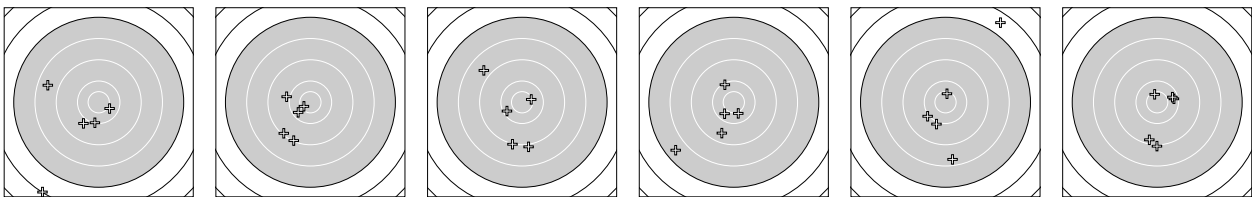

25m Pist. Auflage – Wertung **Senioren I männl.**

StartNr: 396

StandNr: 145

19. Juni 2022 11:47

Tscherwatenko, Klaus Peter #208 WF KKS SV Gevelsberg e.V. / KKS SV Gevelsberg e.V.

Ergebnis: **240** 240 Serien: 31 41 42 44 40 42
Zähler: 4 9 9 4 2 1 Innenzehner: 3

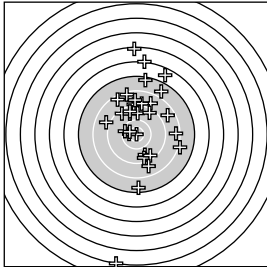

Auflage Wertung

Serie 1:	2.1 ↓ [8.85]	9.0 ↑ [16.15]	5.2 ↑ [22.64]	7.3 ↑ [26.85]	8.2 ↑ [32.83]
Serie 2:	8.3 → [13.68]	7.9 → [20.57]	8.7 ↗ [25.61]	9.5 ↘ [37.94]	9.4 ↘ [45.23]
Serie 3:	9.3 ↘ [12.35]	9.3 ↘ [21.36]	9.6 ↑ [32.28]	9.6 ↑ [40.21]	6.0 ↑ [48.03]
Serie 4:	7.4 ↓ [17.11]	10.9 * [27.43]	10.5 * [34.91]	8.3 ↘ [43.93]	9.4 ↑ [52.51]
Serie 5:	8.7 ↘ [18.55]	8.8 ↖ [26.22]	6.5 ↗ [35.17]	10.2 ← [40.13]	8.9 ↑ [44.32]
Serie 6:	7.7 ↗ [14.59]	8.7 ↑ [25.31]	10.5 * [31.62]	8.5 ↗ [42.14]	9.3 ↗ [48.51]

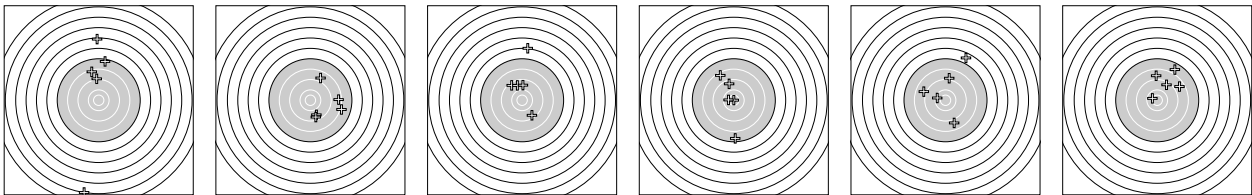

25m Pist. Auflage – Wertung Senioren IV männl.

StartNr: 397

StandNr: 150

19. Juni 2022 11:48

Henning, Werner SV Wengern Oberwengern e.V. / SV Wengern Oberwengern e.V.

Ergebnis: **281** 281 Serien: 46 47 48 46 48 46
 Zähler: 14 13 3 0 0 0 Innenzehner: 4

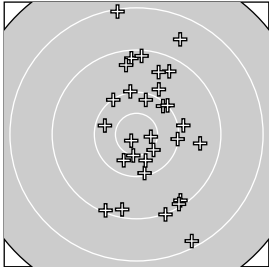

Auflage Wertung

Serie 1:	8.1 ↑ [12.49]	10.1 ↓ [28.90]	10.1 ↘ [46.09]	9.4 ↗ [69.91]	9.1 ↙ [87.08]
Serie 2:	9.0 ↓ [13.12]	10.1 ↗ [30.31]	9.9 ↗ [45.96]	9.5 ↗ [58.97]	10.3 ↙ [73.63]
Serie 3:	10.5 * [17.36]	9.3 ↑ [29.61]	10.4 ↓ [49.42]	10.1 → [91.31]	9.2 ↓ [118.63]
Serie 4:	10.2 ↑ [12.88]	10.8 * [30.81]	8.6 ↗ [48.22]	9.5 → [62.92]	9.3 ↓ [83.15]
Serie 5:	10.6 * [20.49]	9.9 → [45.49]	9.2 ↑ [75.41]	10.0 ↗ [90.69]	10.5 * [117.46]
Serie 6:	9.1 ↓ [31.22]	10.0 ↑ [44.57]	8.2 ↓ [56.94]	9.4 ↑ [74.29]	10.3 ↖ [110.80]

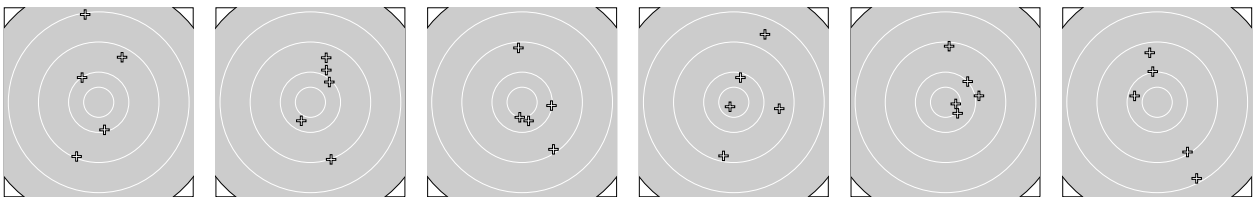

25m Pist. Auflage – Wertung Seniores I männl.

StartNr: 398

StandNr: 149

19. Juni 2022 11:48

Hupp, Heino #07 SV Wengern Oberwengern e.V. / SV Wengern Oberwengern e.V.

Ergebnis: **277** 277 Serien: 43 47 49 45 46 47
 Zähler: 13 12 4 1 0 0 Innenzehner: 4

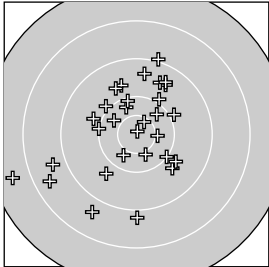

Auflage Wertung

Serie 1:	8.5 ↙ [3.18]	10.4 ↘ [18.84]	9.4 ↑ [35.85]	9.8 ↙ [52.81]	7.6 ← [69.73]
Serie 2:	9.0 ↑ [3.01]	10.0 ↗ [17.82]	9.9 ↘ [36.63]	10.3 ↘ [59.38]	9.9 ↖ [79.99]
Serie 3:	9.8 ↘ [4.74]	10.0 ← [19.63]	10.1 ↑ [38.05]	10.4 * [54.41]	10.0 ↖ [73.26]
Serie 4:	9.7 ↘ [6.56]	8.7 ↘ [23.67]	10.6 * [39.12]	10.3 ↗ [54.23]	8.7 ← [69.56]
Serie 5:	9.7 ↘ [8.50]	9.5 ↗ [23.86]	10.3 ↖ [39.60]	8.9 ↓ [52.19]	10.9 * [65.94]
Serie 6:	9.6 ↗ [5.75]	10.4 * [23.01]	10.1 ↘ [37.61]	9.8 ↘ [52.45]	9.5 ↗ [65.88]

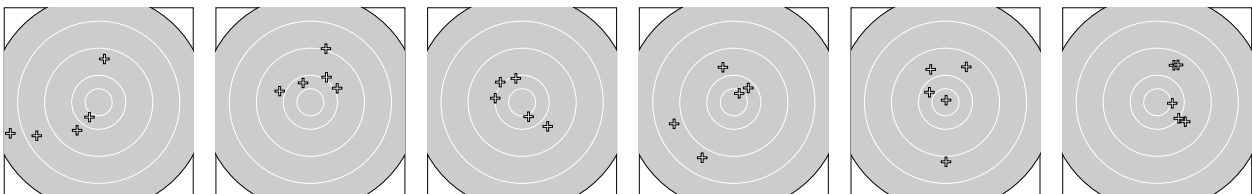

25m Pist. Auflage – Wertung Senioren I männl.

StartNr: 399

StandNr: 148

19. Juni 2022 11:48

Pollet, Frank – SV Wengern Oberwengern e.V. / SV Wengern Oberwengern e.V.

Ergebnis: **266** 266 Serien: 46 47 44 44 40 45
 Zähler: 9 14 3 2 2 0 Innenzehner: 3

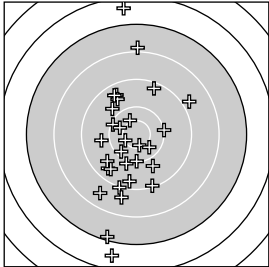

Auflage Wertung

Serie 1:	10.2 ↘ [5.05]	8.6 ↘ [21.99]	9.8 ↘ [41.06]	9.5 ↘ [58.27]	10.6 * [74.89]
Serie 2:	10.1 ↘ [9.81]	9.9 ↓ [25.92]	9.5 ↘ [45.08]	9.0 ↓ [60.53]	10.4 ↘ [79.27]
Serie 3:	10.5 * [3.10]	8.7 ↓ [21.05]	7.9 ↑ [43.62]	9.1 ↘ [63.87]	10.0 → [81.01]
Serie 4:	10.1 ↓ [12.49]	7.2 ↓ [28.28]	9.8 ↘ [47.93]	9.8 ← [64.03]	9.6 ↘ [76.96]
Serie 5:	6.5 ↑ [8.90]	10.4 * [26.68]	9.5 ↘ [40.73]	9.6 ↘ [60.37]	6.6 ↓ [94.87]
Serie 6:	8.8 ↗ [10.90]	9.3 ↑ [28.82]	10.4 ↘ [43.71]	9.4 ↘ [58.33]	9.3 ↓ [75.92]

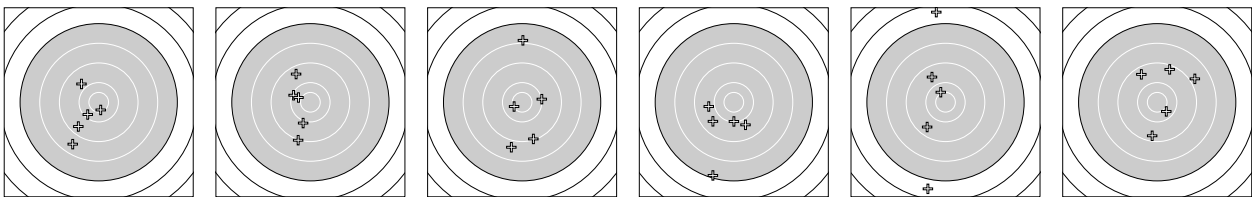

25m Pist. Auflage – Wertung Senioren IV männl.

StartNr: 438

StandNr: 144

19. Juni 2022 11:48

Breier, Karl-Heinz #284

WF BSV 1864 Hemer e.V.

Ergebnis: **258** 258 Serien: 44 38 44 47 45 40
 Zähler: 6 15 6 1 0 0 Innenzehner: 4

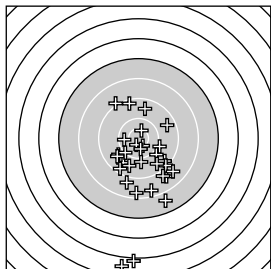

Auflage Wertung

Serie 1:	10.6 * [28.39]	9.3 ↘ [39.17]	8.7 ↘ [73.36]	8.3 ↓ [88.36]	9.1 ↘ [105.17]
Serie 2:	9.5 ↑ [13.56]	4.6 ↓ [29.25]	9.5 ↗ [40.88]	7.7 ↘ [79.07]	9.9 ↓ [110.74]
Serie 3:	8.8 ↓ [11.29]	10.6 * [26.08]	10.6 * [43.46]	8.4 ↓ [59.67]	8.8 ↘ [79.99]
Serie 4:	10.5 * [30.23]	10.3 ← [42.67]	9.3 ↑ [56.71]	9.9 ↘ [70.81]	9.6 ↗ [85.39]
Serie 5:	9.8 ↗ [15.19]	9.0 ↘ [28.90]	10.1 ↗ [43.30]	8.7 ↘ [57.92]	9.7 ↗ [75.56]
Serie 6:	9.6 ↓ [12.25]	9.3 ↗ [25.33]	9.9 ↘ [37.82]	4.9 ↓ [52.64]	9.5 ↘ [66.48]

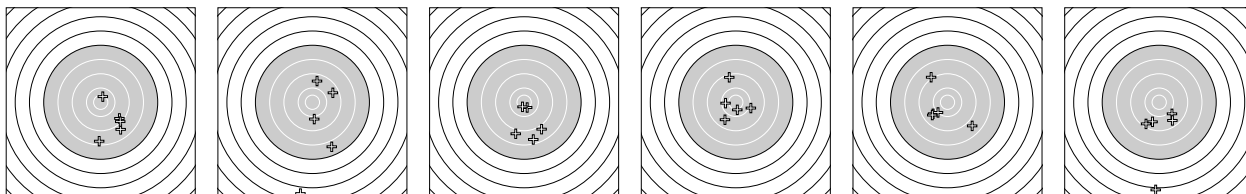

25m Pist. Auflage – Wertung Seniores I männl.

StartNr: 376

StandNr: 143

4. August 2006 5:24

Godwerth, Jürgen 1600 SSG Teutoburger Wald e.V. / SSG Teutoburger Wald e.V.

Ergebnis: **270** 270 Serien: 44 45 45 46 46 44
 Zähler: 8 16 4 2 0 0 Innenzehner: 1

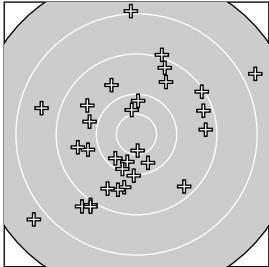

Auflage Wertung

Serie 1:	9.6 ↖ [-1537589.85]	9.7 ↗ [-1537560.76]	9.9 ↖ [-1537537.63]	10.4 ↑ [-1537513.54]	10.7 ↙ [-1537487.54]
Serie 2:	8.6 ↖ [-1537588.76]	10.3 ↓ [-1537563.56]	9.8 ← [-1537534.49]	9.7 ↓ [-1537504.07]	9.6 ← [-1537479.95]
Serie 3:	8.8 ↗ [-1537589.37]	9.0 ↗ [-1537553.56]	9.6 ↗ [-1537527.32]	10.1 ↓ [-1537501.59]	9.1 ↗ [-1537485.66]
Serie 4:	10.2 ↗ [-1537590.20]	10.6 * [-1537560.03]	10.3 ↓ [-1537536.95]	9.7 ↗ [-1537516.39]	9.3 ↗ [-1537489.73]
Serie 5:	9.3 ↘ [-1537591.25]	10.0 ↑ [-1537562.82]	10.2 ↑ [-1537531.05]	9.3 ↑ [-1537502.35]	10.0 ↓ [-1537475.63]
Serie 6:	9.0 ↑ [-1537588.80]	9.6 ↓ [-1537561.40]	9.9 ↗ [-1537532.88]	9.3 → [-1537502.79]	9.5 ↙ [-1537472.50]

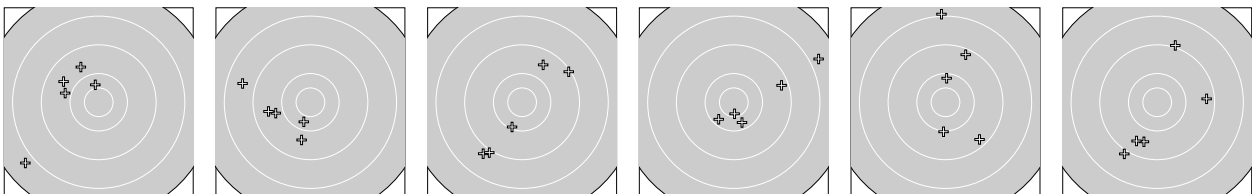

25m Pist. Auflage – Wertung Senioren I männl.

StartNr: 377

StandNr: 144

19. Juni 2022 12:43

Gores, Jürgen #113 1600 SSG Teutoburger Wald e.V. / SSG Teutoburger Wald e.V.

Ergebnis: **247** 247 Serien: 38 42 42 38 46 41
 Zähler: 5 9 11 2 1 1 Innenzehner: 2

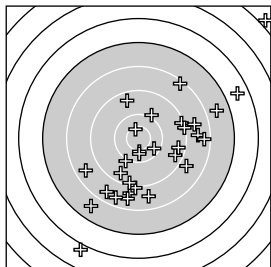

Auflage Wertung

Serie 1:	3.8 ↗ [11.08]	8.6 → [25.22]	9.4 ↑ [32.43]	8.7 ↓ [42.39]	10.6 * [55.42]
Serie 2:	6.5 ↗ [13.04]	9.9 ↗ [40.18]	9.0 ↓ [53.86]	10.3 ↘ [70.94]	8.5 ↓ [90.49]
Serie 3:	9.2 ↗ [12.32]	8.7 → [23.79]	7.6 → [34.10]	8.5 ↗ [47.07]	10.5 * [63.94]
Serie 4:	8.2 ↗ [13.38]	8.4 ↓ [26.27]	5.8 ↘ [48.19]	9.1 → [63.03]	8.5 ↘ [76.17]
Serie 5:	9.4 ↘ [10.53]	9.4 ↘ [23.68]	10.0 ↘ [45.97]	8.8 ↘ [104.64]	10.4 ↓ [115.15]
Serie 6:	8.3 → [17.52]	7.6 ↘ [35.47]	9.4 → [53.05]	9.2 ↓ [63.16]	8.6 ↓ [74.20]

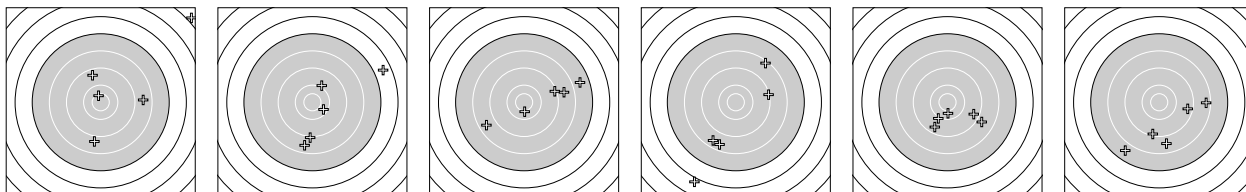

25m Pist. Auflage – Wertung Seniores I männl.

StartNr: 378

StandNr: 142

19. Juni 2022 12:43

Stier, Eckhard #111 1600 SSG Teutoburger Wald e.V. / SSG Teutoburger Wald e.V.

Ergebnis: **237** 237 Serien: 42 34 35 44 41 41
 Zähler: 4 9 7 2 6 2 Innenzehner: 3

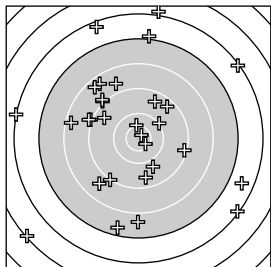

Auflage Wertung

Serie 1:	8.4 ↖ [14.84]	9.0 ↖ [36.18]	10.5 * [59.28]	9.0 ↖ [79.20]	6.0 ← [102.00]
Serie 2:	8.9 ↖ [19.45]	5.9 ↑ [37.71]	5.1 ↗ [60.35]	7.4 ↓ [80.02]	9.4 ↑ [100.12]
Serie 3:	6.3 ↖ [25.06]	6.9 ↑ [47.58]	6.1 ↖ [68.28]	9.2 → [90.54]	8.7 ↖ [107.42]
Serie 4:	9.5 ↓ [11.52]	9.8 ↖ [39.37]	10.0 ↗ [60.63]	8.7 ↗ [83.80]	8.9 ↖ [103.67]
Serie 5:	8.3 ← [12.58]	6.5 → [41.97]	10.6 * [68.02]	9.0 ↗ [90.10]	8.4 ↖ [112.09]
Serie 6:	6.1 ↗ [10.08]	9.3 ↗ [35.75]	10.8 * [58.16]	7.7 ↓ [80.15]	9.5 ↖ [104.85]

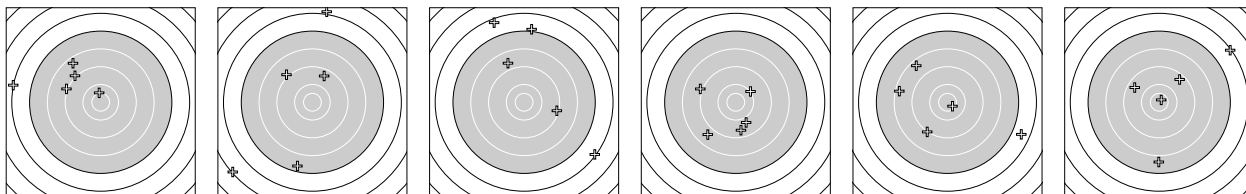

25m Pist. Auflage – Wertung Senioren IV männl.

StartNr: 426

StandNr: 149

19. Juni 2022 12:42

Kammering, Ferdinand #149 SV Volmarstein 1930 e.V. / SV Volmarstein 1930 e.V.

Ergebnis: **252** 252 Serien: 44 43 39 42 40 44
 Zähler: 8 9 4 5 4 0 Innenezehner: 2

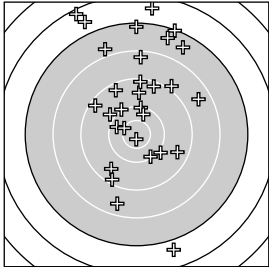

Auflage Wertung

Serie 1:	8.5 ↓ [5.78]	10.3 ↖ [20.42]	9.6 ↑ [34.51]	7.2 ↑ [45.70]	10.0 ↘ [53.68]
Serie 2:	10.5 * [10.10]	9.5 ↗ [22.54]	7.8 ↘ [33.98]	10.0 ↘ [41.68]	7.1 ↑ [49.13]
Serie 3:	9.3 ↖ [12.50]	9.3 ↘ [22.76]	7.4 ↑ [31.58]	6.5 ↑ [39.50]	8.5 ↗ [50.05]
Serie 4:	6.7 ↓ [9.76]	9.5 ↘ [20.58]	8.3 ↑ [33.76]	10.1 ↘ [42.44]	9.2 ↑ [50.06]
Serie 5:	9.2 ↓ [5.76]	6.2 ↘ [15.88]	9.2 ↑ [24.20]	6.6 ↘ [34.41]	10.1 ↑ [40.71]
Serie 6:	10.3 ↑ [7.82]	8.9 ↗ [20.17]	10.8 * [30.84]	9.9 ↖ [40.36]	7.5 ↗ [51.05]

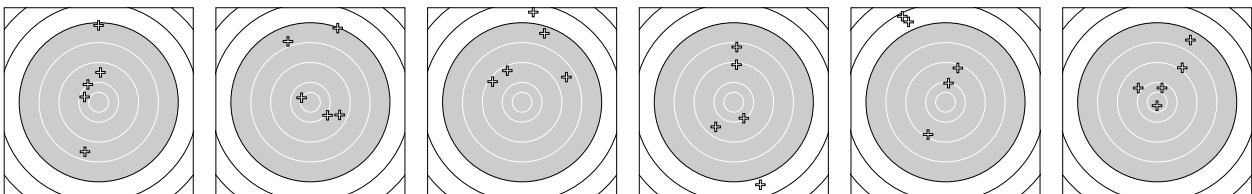

25m Pist. Auflage – Wertung Senioren III männl.

StartNr: 427

StandNr: 148

19. Juni 2022 12:42

Kothe, Hans-Jürgen #311 WF SV Volmarstein 1930 e.V. / SV Volmarstein 1930 e.V.

Ergebnis: **232** 232 Serien: 44 38 33 31 46 40
 Zähler: 8 8 2 5 2 2 Innenzehner: 0

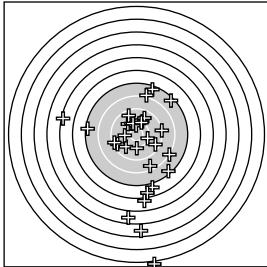

Auflage Wertung

Serie 1:	6.7 ↓ [9.77]	10.1 ↘ [17.88]	9.4 ↙ [24.32]	10.0 ↖ [31.08]	9.8 ↗ [38.50]
Serie 2:	5.2 ← [12.72]	10.0 ↓ [19.80]	7.3 ↗ [22.43]	7.2 ← [27.92]	9.2 ↖ [35.05]
Serie 3:	7.3 ↑ [14.12]	6.4 ↓ [20.92]	10.1 ↖ [29.95]	3.5 ↓ [37.28]	7.3 ↘ [43.03]
Serie 4:	9.4 ↘ [8.21]	0.0 ↓ [18.94]	5.8 ↓ [27.60]	7.9 ↑ [35.26]	10.1 ← [40.17]
Serie 5:	8.0 ↘ [13.84]	9.9 ↑ [19.38]	10.3 ↑ [28.19]	10.1 ↖ [37.12]	9.6 ↑ [44.89]
Serie 6:	10.0 ↑ [11.96]	9.5 ↖ [20.42]	8.4 ↓ [27.78]	9.1 → [37.63]	4.5 ↓ [46.61]

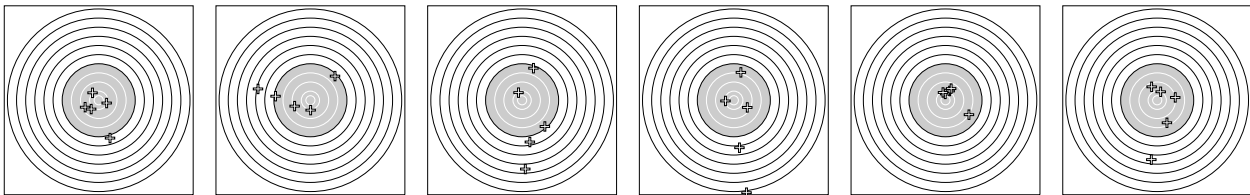

25m Pist. Auflage – Wertung Seniore V männl.

StartNr: 428

StandNr: 150

19. Juni 2022 12:42

Neuburg, Peter #310

WF SV Volmarstein 1930 e.V. / SV Volmarstein 1930 e.V.

Ergebnis: **263** 263 Serien: 48 43 46 40 41 45
 Zähler: 5 17 6 1 0 1 Innenzehner: 0

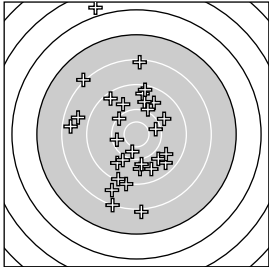

Auflage Wertung

Serie 1:	10.2 ← [7.67]	9.3 ↘ [14.01]	10.3 ↓ [20.67]	10.1 ↖ [29.41]	9.8 ↗ [39.81]
Serie 2:	9.7 ↙ [7.84]	9.7 ↖ [19.24]	9.7 ↓ [31.35]	8.6 ↙ [38.26]	8.4 ← [48.00]
Serie 3:	9.6 ↘ [9.61]	10.2 → [17.20]	9.4 ↘ [24.20]	9.7 ↘ [32.15]	9.4 ↑ [39.61]
Serie 4:	5.7 ↑ [12.96]	8.1 ↓ [22.58]	9.0 ↓ [32.07]	9.6 ↑ [43.62]	9.7 ↑ [57.68]
Serie 5:	8.6 ← [9.79]	7.9 ↓ [21.42]	8.2 ↑ [32.78]	9.1 ↙ [41.85]	9.9 ↙ [52.20]
Serie 6:	8.0 ↘ [9.68]	10.0 ↑ [19.84]	9.6 ↘ [29.20]	9.2 ↑ [40.81]	9.9 ↓ [59.12]

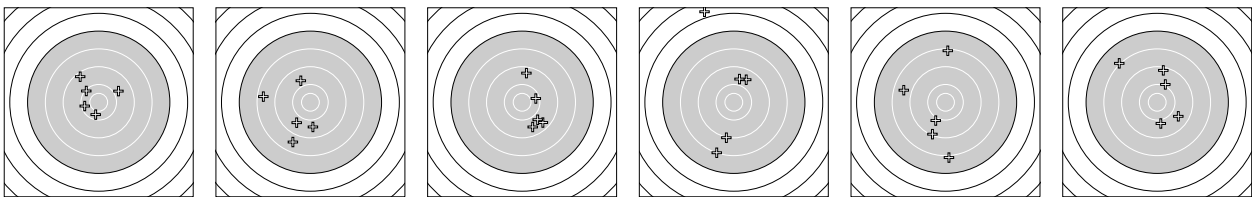

25m Pist. Auflage – Wertung Senioren III männl.

StartNr: 430

StandNr: 147

19. Juni 2022 12:43

Möllmann, Robert #309

WF SV Volmarstein 1930 e.V.

Ergebnis: **273** 273 Serien: 42 45 48 46 48 44
 Zähler: 11 13 4 2 0 0 Innenzehner: 3

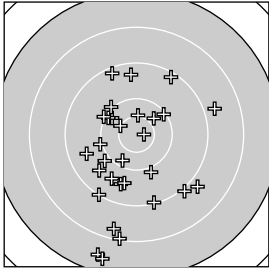

Auflage Wertung

Serie 1:	7.5 ↓ [17.71]	9.2 ↗ [32.58]	9.2 ↗ [50.68]	7.5 ↓ [72.58]	10.2 ↘ [83.68]
Serie 2:	10.2 ↘ [7.98]	9.6 ↘ [31.31]	9.1 ↘ [50.14]	9.4 ↑ [64.21]	8.1 ↓ [80.14]
Serie 3:	9.0 ↘ [14.80]	10.5 * [31.46]	9.6 ↖ [45.58]	10.5 * [65.58]	10.4 ↗ [82.61]
Serie 4:	9.9 ↓ [15.29]	9.6 ↓ [29.30]	10.1 ↘ [43.77]	10.1 ↗ [60.26]	8.8 → [76.12]
Serie 5:	10.8 * [19.52]	10.0 ↘ [43.88]	9.6 ↗ [62.17]	10.0 ↘ [78.66]	9.7 ↓ [96.06]
Serie 6:	9.1 ↓ [9.40]	10.0 ↖ [27.60]	8.8 ↘ [48.87]	9.9 ↗ [69.69]	8.3 ↓ [93.60]

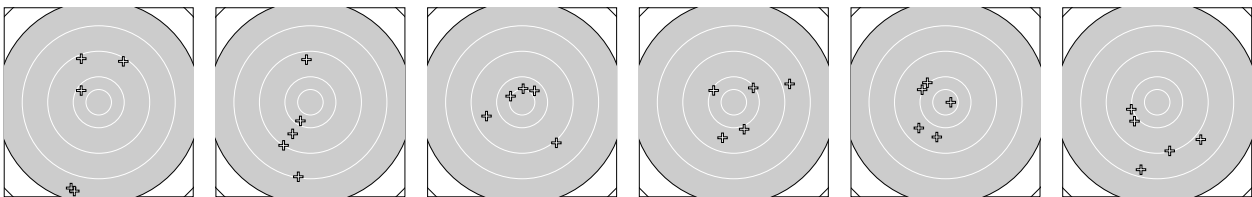

25m Pist. Auflage – Wertung Senioren IV männl.

StartNr: 433

StandNr: 145

19. Juni 2022 12:43

Niemann, Fritz #103

1600 SSG Teutoburger Wald e.V.

Ergebnis: **272** 272 Serien: 46 45 48 45 40 48
 Zähler: 14 10 3 1 1 1 Innenzehner: 6

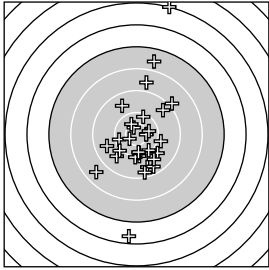

Auflage Wertung

Serie 1:	9.5 ↓ [10.70]	10.6 * [32.78]	9.6 ← [58.77]	8.7 ↑ [81.47]	10.2 ← [99.42]
Serie 2:	9.3 ↓ [13.34]	10.1 ↓ [35.68]	9.8 ↘ [56.38]	7.6 ↑ [77.43]	10.5 * [100.61]
Serie 3:	9.4 ↘ [13.25]	10.6 * [33.35]	10.2 ↑ [46.40]	9.7 ↘ [61.63]	10.0 ↓ [78.23]
Serie 4:	6.4 ↓ [17.14]	10.6 * [37.45]	10.1 ↘ [61.40]	10.4 * [74.87]	9.4 ↗ [88.33]
Serie 5:	8.5 ↗ [54.79]	5.1 ↑ [74.77]	8.9 ↗ [90.53]	10.2 ↓ [100.52]	9.9 → [109.46]
Serie 6:	9.7 ↗ [11.66]	9.6 ↘ [29.07]	10.2 ↓ [47.86]	10.5 * [66.28]	10.0 ↗ [85.43]

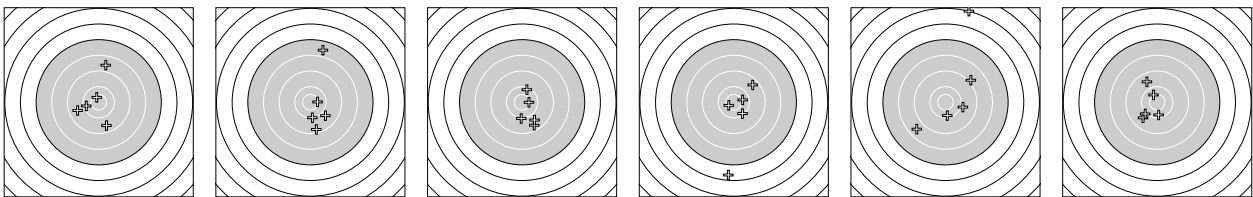

25m Pist. Auflage – Wertung Senioren V männl.

StartNr: 440

StandNr: 146

19. Juni 2022 12:44

Wernemann, Marie-Louise #109

1600 SSG Teutoburger Wald e.V.

Ergebnis: **203** 203 Serien: 39 34 44 42 32 12
 Zähler: 3 5 5 9 2 1 Innenzehner: 0

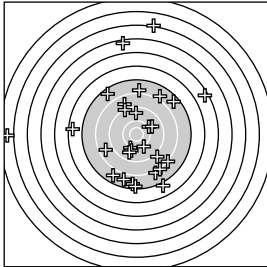

Auflage Wertung

Serie 1:	8.8 ↘ [31.73]	7.9 ↘ [41.00]	10.0 ↙ [51.93]	7.4 ↗ [65.41]	7.8 ↑ [79.03]
Serie 2:	7.6 ↗ [15.34]	6.4 ← [29.29]	5.3 ↗ [40.28]	7.4 ↓ [51.51]	9.8 ↙ [64.65]
Serie 3:	8.7 ↖ [16.17]	7.2 ↓ [29.40]	10.0 ↘ [44.82]	10.0 ↗ [59.71]	9.8 ↗ [74.44]
Serie 4:	9.6 ↙ [9.45]	8.5 ← [25.39]	9.1 ↖ [37.25]	9.5 ↑ [51.07]	7.8 ↗ [65.89]
Serie 5:	7.6 ↙ [9.96]	7.4 ↘ [23.75]	4.3 ↑ [36.30]	8.0 ↘ [51.21]	6.8 ↘ [62.44]
Serie 6:	8.0 ↘ [11.68]	1.6 ← [20.20]	3.0 ↑ [66.81]	0.0 [0.00] _{PAD}	0.0 [0.00] _{PAD}

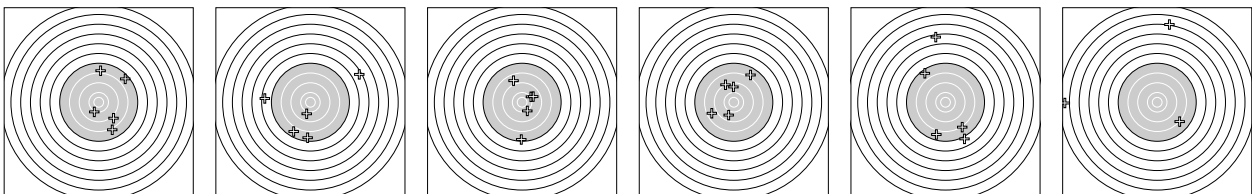

PAD – Treffer wurde erzeugt um eine unvollständige Serie aufzufüllen



25m Pist. Auflage – Wertung Seniores I männl.

StartNr: 390

StandNr: 147

19. Juni 2022 13:36

Rösler, Christian #435

6000 SV Meiswinkel e.V. / SV Meiswinkel e.V.

Ergebnis: **273** 273 Serien: 47 46 43 45 46 46
Zähler: 11 13 4 2 0 0 Innenezehner: 4

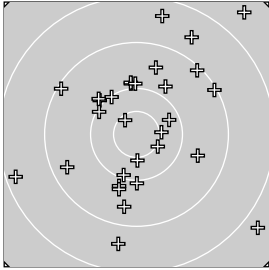

Auflage Wertung

Serie 1:	9.9 ↓ [10.93]	9.8 ↗ [41.27]	10.6 * [60.90]	10.0 ↘ [73.74]	9.1 ↗ [86.92]
Serie 2:	10.5 * [6.97]	10.1 ↘ [16.00]	9.5 ↑ [30.55]	10.1 ↘ [42.12]	7.5 ↗ [59.12]
Serie 3:	9.1 ↗ [23.96]	9.9 ↑ [38.72]	9.1 ↘ [50.60]	7.7 ↘ [80.54]	9.9 ↘ [92.11]
Serie 4:	9.9 ↑ [5.87]	10.3 ↗ [21.83]	8.6 ↓ [62.87]	10.1 ↓ [70.99]	8.6 ↗ [94.10]
Serie 5:	9.4 ↖ [7.05]	8.4 ↑ [19.20]	10.4 * [48.80]	10.0 ↑ [59.40]	9.8 ↓ [85.08]
Serie 6:	9.5 ↓ [9.09]	9.7 ↘ [33.93]	10.5 * [74.88]	10.0 ↓ [99.98]	8.3 ↖ [112.67]

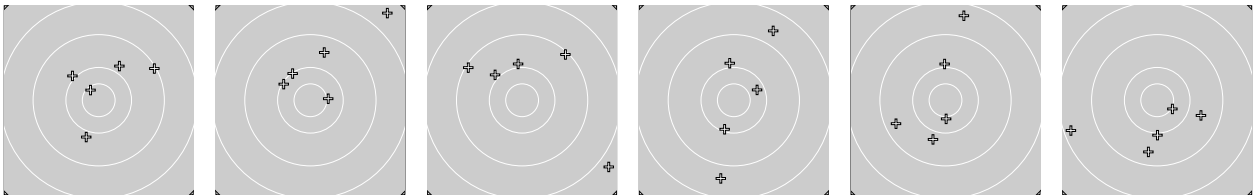

25m Pist. Auflage – Wertung Senioren V männl.

StartNr: 421

StandNr: 142

19. Juni 2022 13:35

Emde, Karl Heinz #427

6000 SV Weidenau / SV Weidenau

Ergebnis: **270** 270 Serien: 39 45 46 49 44 47
 Zähler: 12 10 5 2 1 0 Innenzehner: 7

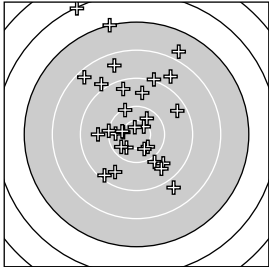

Auflage Wertung

Serie 1:	7.8 ↗ [14.44]	6.1 ↘ [21.30]	9.4 ↗ [33.80]	8.3 ↘ [43.94]	9.7 ← [56.56]
Serie 2:	9.4 ↗ [15.96]	7.1 ↗ [29.01]	10.3 ↗ [41.87]	10.4 * [54.12]	9.0 ↑ [63.91]
Serie 3:	9.9 ↘ [12.37]	10.3 ← [26.84]	10.5 * [38.58]	8.8 ↘ [48.04]	9.7 ↘ [60.95]
Serie 4:	10.1 ↘ [16.04]	10.5 * [29.60]	10.6 * [41.14]	10.4 * [53.23]	9.5 ↘ [65.46]
Serie 5:	10.7 * [14.08]	8.7 ↗ [23.56]	8.5 ↗ [35.59]	8.9 ↘ [45.87]	10.4 * [58.17]
Serie 6:	9.6 ↘ [18.24]	9.2 ↗ [29.19]	10.1 ← [42.57]	10.3 ↗ [54.15]	9.6 ↑ [68.68]

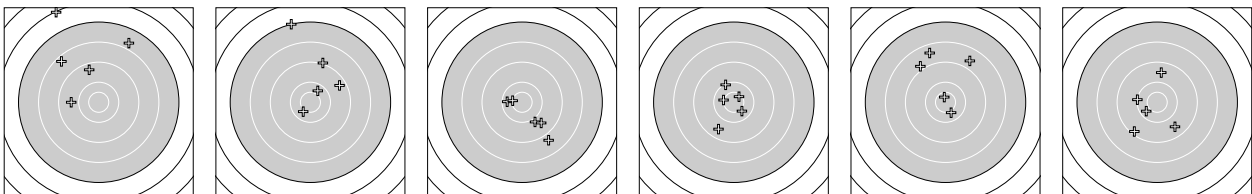

25m Pist. Auflage – Wertung Senioren IV männl.

StartNr: 425

StandNr: 149

19. Juni 2022 13:36

Lorsbach, Horst #429

6000 SV Meiswinkel e.V. / SV Meiswinkel e.V.

Ergebnis: **273** 273 Serien: 44 47 45 48 47 42
 Zähler: 12 11 5 2 0 0 Innenezehner: 4

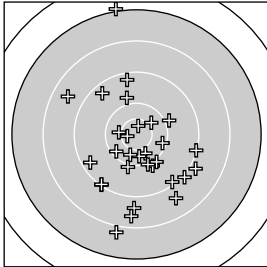

Auflage Wertung

Serie 1:	10.2 ↙ [11.08]	7.9 ↓ [27.55]	8.7 ↓ [46.36]	10.3 ↘ [71.00]	9.9 ↘ [89.34]
Serie 2:	10.0 ↘ [10.70]	10.7 * [30.79]	10.0 ↓ [50.79]	8.7 ↘ [74.99]	9.1 ↙ [87.64]
Serie 3:	9.3 ↙ [8.35]	9.2 ↘ [24.05]	9.9 ↗ [46.09]	8.4 ↓ [66.37]	10.3 ↓ [80.09]
Serie 4:	10.3 ↓ [8.00]	10.4 * [30.94]	9.3 ↑ [53.81]	10.7 * [74.62]	9.1 ↘ [100.74]
Serie 5:	9.1 ↙ [6.46]	9.3 ↘ [24.57]	10.0 ↘ [45.81]	9.8 ↑ [67.35]	10.2 ↘ [87.65]
Serie 6:	8.5 ↘ [7.13]	8.9 ↘ [27.49]	9.0 ↘ [47.45]	10.4 * [67.94]	7.0 ↑ [81.04]

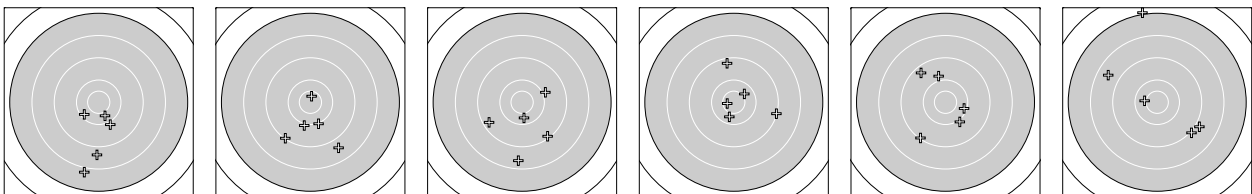

25m Pist. Auflage – Wertung Seniores I männl.

StartNr: 400

StandNr: 148

19. Juni 2022 14:52

Kindler, Michael #172

3200 SV Pavenstädt e.V.

Ergebnis: **287** 287 Serien: 46 48 48 49 48 48
Zähler: 20 7 3 0 0 0 Innenezehner: 12

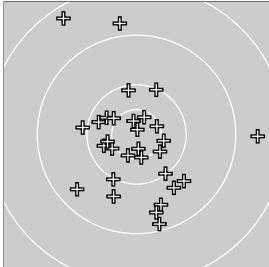

Auflage Wertung

Serie 1:	10.1 ↑ [8.47]	8.6 → [26.53]	9.4 ↙ [40.88]	9.7 ↘ [56.68]	10.5 * [71.07]
Serie 2:	10.1 ↘ [16.69]	9.7 ↘ [33.49]	9.6 ↘ [47.39]	10.7 * [63.76]	10.5 * [78.83]
Serie 3:	10.2 ↖ [30.10]	10.4 * [44.80]	8.8 ↑ [83.21]	10.6 * [92.98]	10.4 * [105.47]
Serie 4:	10.3 ↖ [25.33]	10.3 ↖ [36.18]	10.1 ↑ [50.09]	10.4 * [62.47]	9.2 ↘ [75.82]
Serie 5:	10.4 * [7.33]	9.7 ↓ [24.23]	9.4 ↓ [41.84]	10.6 * [57.86]	10.9 * [94.94]
Serie 6:	10.7 * [9.86]	10.4 * [25.25]	10.0 ↙ [60.97]	8.3 ↘ [76.71]	10.0 ← [89.14]

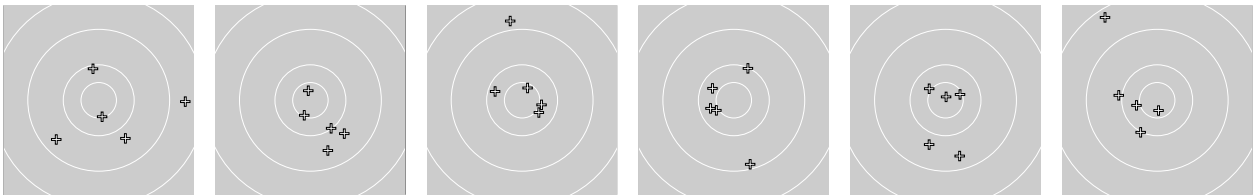

25m Pist. Auflage – Wertung Seniores I männl.

StartNr: 407

StandNr: 145

19. Juni 2022 14:52

Jolly, Claude #32

WF Arnsberger BSGes. e.V.

Ergebnis: **272** 272 Serien: 46 48 45 42 44 47
 Zähler: 10 13 6 1 0 0 Innenezehner: 3

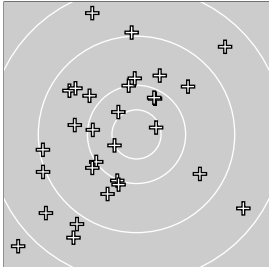

Auflage Wertung

Serie 1:	10.2 ↗ [6.85]	8.5 ↗ [19.09]	9.8 ↗ [30.90]	9.6 ↗ [41.21]	10.2 ↗ [53.46]
Serie 2:	10.1 ← [9.92]	9.5 ↘ [22.59]	10.0 ↓ [34.94]	9.0 ← [54.78]	10.1 ↖ [73.89]
Serie 3:	9.9 ↗ [15.49]	9.7 ↓ [29.41]	9.8 ← [42.64]	8.4 ↗ [69.31]	10.5 * [75.82]
Serie 4:	8.6 ↗ [14.33]	9.4 ↘ [32.40]	7.7 ↗ [49.77]	9.1 ← [67.25]	9.8 ↘ [82.31]
Serie 5:	8.4 ↘ [7.68]	8.9 ↗ [22.66]	9.5 ↘ [40.29]	10.0 ↑ [61.61]	9.0 ↑ [78.87]
Serie 6:	10.0 ↓ [10.82]	9.9 ↑ [25.62]	8.6 ↗ [48.50]	10.4 * [64.75]	10.6 * [76.77]

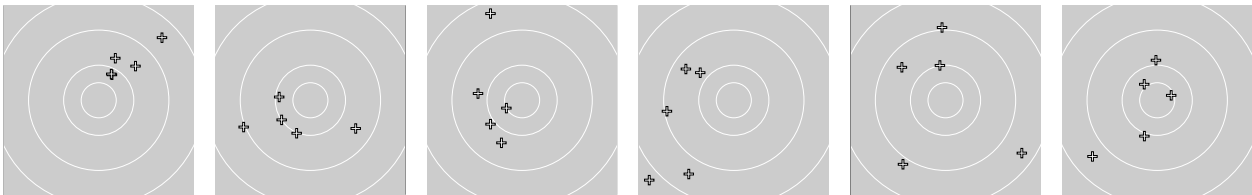

25m Pist. Auflage – Wertung Senioren V männl.

StartNr: 420

StandNr: 144

19. Juni 2022 14:51

Egge, Rolf #426

6000 SV Weidenau / SV Weidenau

Ergebnis: **213** 213 Serien: 40 26 38 44 35 30
 Zähler: 3 9 4 5 2 3 Innenzehner: 1

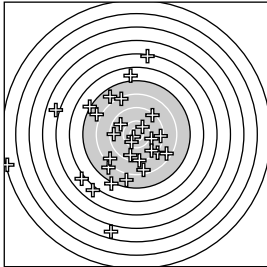

Auflage Wertung

Serie 1:	7.6 ↖ [27.37]	8.2 ↖ [37.42]	9.9 → [51.04]	7.7 ↖ [60.74]	9.1 ↓ [74.35]
Serie 2:	5.8 ↗ [19.14]	5.8 ↗ [47.52]	7.6 ↓ [58.15]	3.6 ↓ [71.78]	6.9 ↗ [84.41]
Serie 3:	4.8 ↖ [7.08]	8.4 ↓ [16.45]	7.0 ↖ [30.25]	10.7 * [59.23]	9.5 ↓ [70.30]
Serie 4:	9.7 ↖ [14.15]	9.3 → [22.62]	10.3 ↗ [33.83]	7.8 ↗ [45.65]	9.0 ↖ [55.85]
Serie 5:	10.3 ↗ [28.64]	8.4 ↗ [42.37]	9.4 ← [53.22]	8.4 ↖ [60.79]	0.0 [0.00] ^{PAD}
Serie 6:	5.2 ↑ [13.61]	6.7 ↑ [22.72]	9.2 ↗ [30.97]	9.4 ↖ [40.70]	1.2 ← [50.51] ^{PAD}

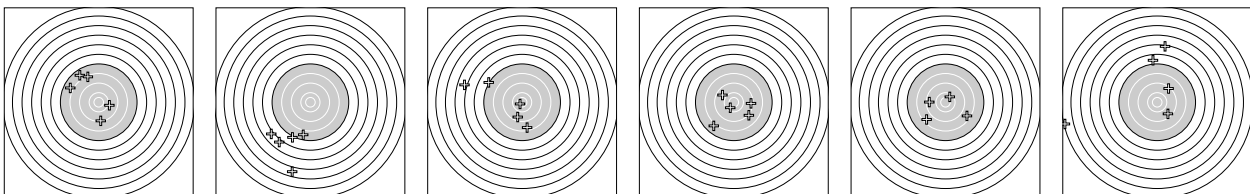

PAD – Treffer wurde erzeugt um eine unvollständige Serie aufzufüllen



25m Pist. Auflage – Wertung Senioren V männl.

StartNr: 422

StandNr: 141

19. Juni 2022 14:52

Götttert, Peter #428

6000 SV Weidenau / SV Weidenau

Ergebnis: **240** 240 Serien: 42 42 43 37 37 39
 Zähler: 4 9 8 6 0 2 Innenzehner: 2

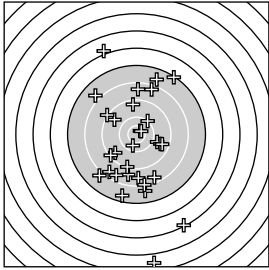

Auflage Wertung

Serie 1:	10.0 ↗ [8.01]	8.7 ↓ [25.80]	7.9 ↘ [44.39]	9.3 ↑ [60.65]	8.5 ↓ [78.13]
Serie 2:	10.7 * [9.36]	9.5 ↘ [26.21]	7.8 ↘ [45.46]	7.1 ↗ [84.56]	9.8 ↘ [102.61]
Serie 3:	10.3 ↓ [9.01]	9.0 ↘ [42.60]	9.4 ↘ [58.96]	7.7 ↓ [85.58]	8.4 ↗ [100.61]
Serie 4:	9.6 ↘ [18.66]	8.4 ↓ [35.79]	9.1 ↓ [55.43]	3.5 ↓ [75.61]	8.4 ↑ [89.25]
Serie 5:	5.1 ↘ [14.65]	8.4 ↓ [29.58]	8.1 ↓ [57.40]	7.4 ↓ [75.54]	9.5 ↘ [102.88]
Serie 6:	7.7 ↑ [6.86]	5.9 ↘ [25.44]	8.3 ↑ [42.62]	10.7 * [70.47]	9.1 ↘ [97.82]

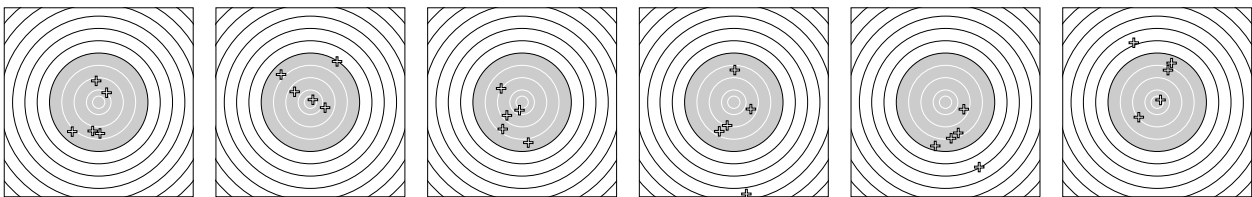

25m Pist. Auflage – Wertung Senioren III männl.

StartNr: 431

StandNr: 146

19. Juni 2022 14:52

Nüse, Reinhold #35

WF SpSch St. Hubertus Brilon e.V.

Ergebnis: **282** 282 Serien: 48 47 47 46 46 48
 Zähler: 16 10 4 0 0 0 Innenzehner: 6

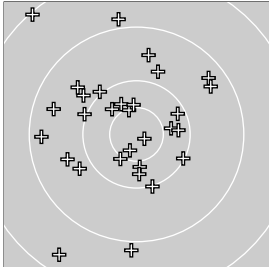

Auflage Wertung

Serie 1:	10.4 → [9.81]	10.2 → [27.88]	8.1 ↘ [40.77]	10.7 * [57.20]	10.0 ↖ [75.83]
Serie 2:	10.8 * [9.44]	10.0 ↘ [30.23]	9.4 ↖ [48.31]	10.5 * [68.89]	8.9 ↑ [80.58]
Serie 3:	9.6 ↑ [9.88]	10.4 ↘ [31.79]	10.4 * [53.79]	9.8 ↑ [70.49]	9.8 ↙ [93.09]
Serie 4:	9.4 ↗ [14.40]	10.0 ↓ [29.22]	10.5 * [47.49]	8.4 ↗ [65.34]	9.3 ← [87.06]
Serie 5:	9.4 ↗ [28.56]	10.1 ↘ [44.22]	8.9 ↓ [61.99]	10.4 ↘ [74.40]	9.8 ↘ [93.25]
Serie 6:	10.2 ↗ [23.38]	10.3 ↓ [37.91]	9.7 ↘ [52.09]	10.5 * [67.34]	9.7 ↙ [84.67]

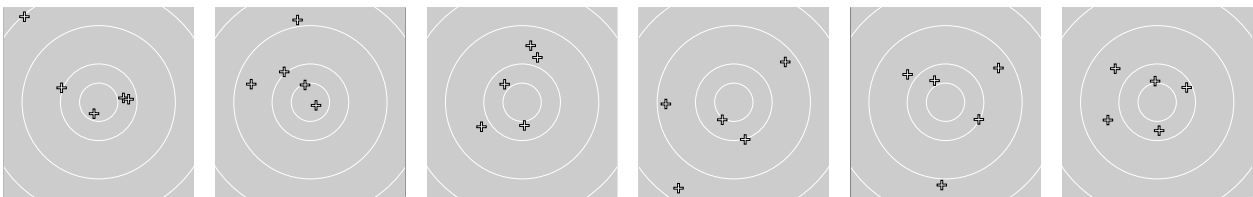

25m Pist. Auflage – Wertung Senioren IV männl.

StartNr: 436

StandNr: 149

19. Juni 2022 14:51

Dammeyer, Hans-Peter #231

3500 SV Barkhausen Porta e.V.

Ergebnis: **254** 254 Serien: 40 36 41 43 48 46
 Zähler: 8 13 5 1 0 2 Innenzehner: 3

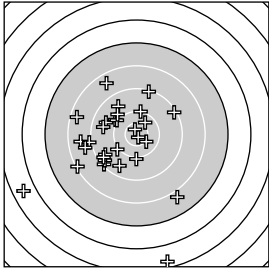

Auflage Wertung

Serie 1:	8.1 ↙ [9.62]	10.4 ↗ [16.08]	8.6 ← [20.90]	5.3 ↓ [26.69]	9.1 ↑ [37.17]
Serie 2:	9.6 ↖ [10.21]	9.0 ← [18.03]	9.6 ← [37.66]	9.9 ↘ [48.72]	0.0 [0.00] ^{PAD}
Serie 3:	7.8 ↘ [10.29]	8.5 ↘ [30.74]	8.3 ↖ [38.13]	9.1 ↗ [44.87]	9.3 ↗ [52.65] ^{PAD}
Serie 4:	5.5 ↙ [8.89]	10.0 ↑ [17.49]	10.5 * [24.59]	9.4 ↗ [33.16]	9.5 ↗ [41.48]
Serie 5:	9.6 ↘ [19.39]	9.2 ↗ [27.50]	10.0 ↓ [40.29]	10.8 * [49.09]	10.0 ↗ [75.71]
Serie 6:	10.0 ↘ [11.43]	9.9 ↘ [20.56]	10.7 * [31.75]	8.7 ← [47.81]	9.3 ↗ [60.52]

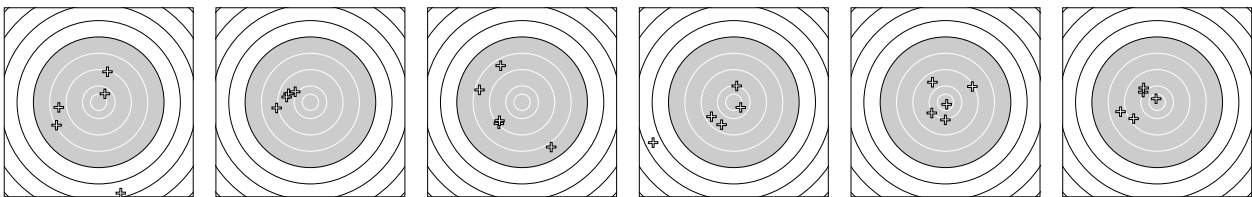

PAD – Treffer wurde erzeugt um eine unvollständige Serie aufzufüllen



25m Pist. Auflage – Wertung Senioren IV männl.

StartNr: 439

StandNr: 147

19. Juni 2022 14:51

Neumann, Henning #39

WF SpSch St. Hubertus Brilon e.V.

Ergebnis: **246** 246 Serien: 37 43 35 41 45 45
 Zähler: 5 8 9 5 2 1 Innenzehner: 2

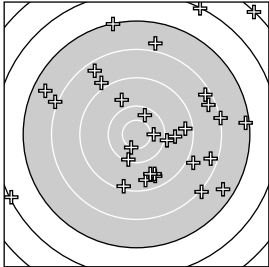

Auflage Wertung

Serie 1:	8.9 ↘ [1.66]	7.5 ↘ [10.21]	8.0 ↘ [18.76]	6.1 ↙ [27.21]	8.4 ↘ [35.07]
Serie 2:	9.4 ↓ [3.70]	10.3 ↑ [14.31]	8.3 → [22.37]	8.8 ↘ [30.87]	8.0 ↘ [42.49]
Serie 3:	9.5 ↓ [1.97]	5.1 ↗ [55.02]	7.4 ↘ [76.19]	6.1 ↑ [116.14]	8.3 → [130.28]
Serie 4:	9.7 → [2.38]	7.8 ↑ [17.61]	7.2 → [50.32]	10.5 * [66.79]	8.0 → [86.12]
Serie 5:	8.3 ↗ [2.57]	9.2 ↓ [17.87]	9.5 ↓ [27.53]	10.0 → [37.22]	9.6 ↓ [60.34]
Serie 6:	9.7 ↘ [4.36]	7.1 ↑ [10.65]	9.3 → [17.72]	10.1 ↓ [25.61]	10.4 * [34.48]

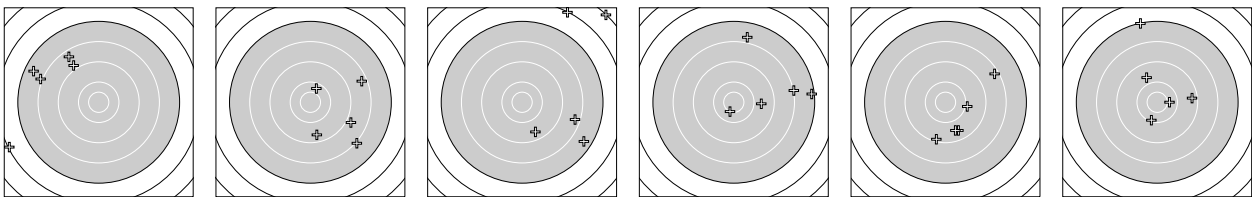

25m Pist. Auflage – Wertung Seniores I männl.

StartNr: 442

StandNr: 150

19. Juni 2022 14:52

Bäumer, Susanne #229

SV Barkhausen Porta e.V.

Ergebnis: **281** 281 Serien: 46 46 48 45 48 48
Zähler: 15 11 4 0 0 0 Innenzehner: 3

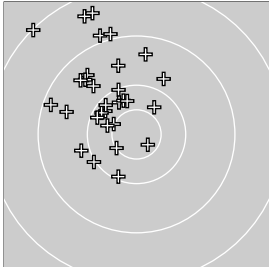

Auflage Wertung

Serie 1:	8.1 ↘ [30.30]	9.7 ↘ [48.93]	10.5 * [58.70]	9.5 ↘ [70.42]	10.2 ↘ [85.56]
Serie 2:	10.1 ↗ [26.35]	9.9 ← [43.13]	9.4 ↑ [70.11]	8.4 ↗ [91.19]	10.4 ↘ [126.64]
Serie 3:	9.8 ↗ [18.96]	10.3 ↘ [51.71]	9.6 ↑ [61.97]	10.4 ↗ [79.26]	10.5 * [96.66]
Serie 4:	8.9 ↗ [18.11]	9.2 ↘ [32.34]	9.0 ↑ [55.71]	10.2 ↘ [75.56]	9.5 ↘ [89.50]
Serie 5:	10.2 ↘ [20.77]	9.5 ↘ [39.48]	10.3 ↘ [58.54]	10.2 ↘ [76.15]	9.6 ↘ [97.94]
Serie 6:	10.0 ↙ [30.57]	10.3 ↑ [50.76]	10.7 * [71.48]	10.1 ↘ [89.84]	8.4 ↗ [108.86]

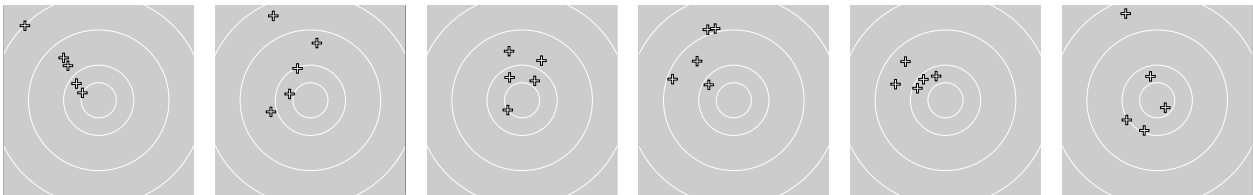

25m Pist. Auflage – Wertung Seniores I männl.

StartNr: 382

StandNr: 149

19. Juni 2022 15:47

Müller, Michael #216 3400 PoISV Lippe–Detmold e.V. / PoISV Lippe–Detmold e.V.

Ergebnis: **274** 274 Serien: 46 45 48 42 49 44
 Zähler: 13 11 3 3 0 0 Innenezehner: 3

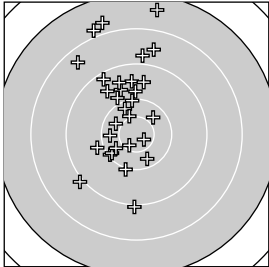

Auflage Wertung

Serie 1:	9.7 ↗ [13.28]	10.4 ↘ [26.48]	10.6 * [50.69]	8.4 ↖ [73.08]	9.2 ↖ [95.01]
Serie 2:	10.0 ↘ [13.11]	9.5 ↑ [23.64]	7.5 ↑ [41.64]	10.1 ↙ [59.47]	9.6 ↖ [89.29]
Serie 3:	10.2 ↖ [15.75]	10.7 * [32.20]	9.9 ↖ [60.92]	10.1 ↑ [89.99]	9.0 ↙ [114.79]
Serie 4:	9.6 ↑ [18.37]	7.9 ↖ [33.43]	7.7 ↖ [57.70]	10.3 ↘ [79.66]	9.5 ↖ [108.01]
Serie 5:	9.8 ↑ [15.78]	10.2 ↙ [32.42]	10.3 ↙ [58.88]	10.3 ↗ [86.66]	10.5 * [109.63]
Serie 6:	10.3 ← [16.27]	8.6 ↑ [32.51]	9.0 ↓ [54.33]	9.9 ← [78.86]	8.8 ↑ [91.64]

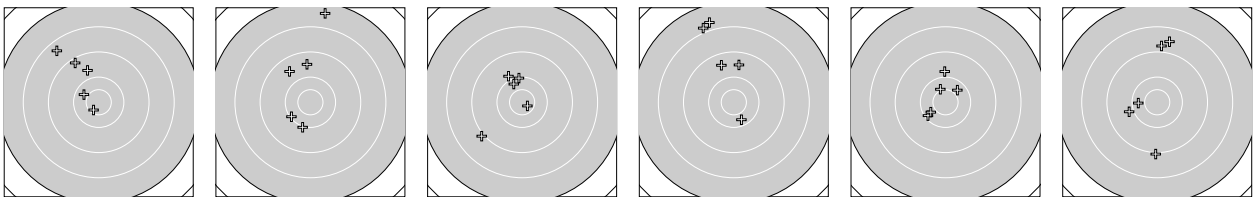

25m Pist. Auflage – Wertung Seniores I männl.

StartNr: 401

StandNr: 147

19. Juni 2022 15:48

Schmidt, Wolfgang #211

3400 ABS Blomberg

Ergebnis: **285** 285 Serien: 47 47 49 48 47 47
 Zähler: 17 11 2 0 0 0 Innenezehner: 8

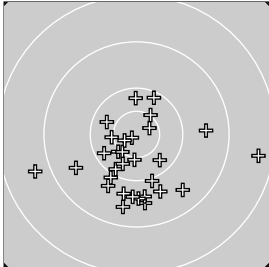

Auflage Wertung

Serie 1:	8.4 → [23.88]	10.7 * [59.38]	9.8 ↓ [76.04]	10.2 ↙ [99.30]	10.5 * [140.43]
Serie 2:	10.2 ↗ [22.20]	9.6 ↓ [54.14]	9.7 ↓ [63.90]	9.5 ↓ [93.43]	10.0 ↘ [108.98]
Serie 3:	10.3 ↖ [47.31]	10.5 * [55.10]	10.5 * [68.56]	9.5 ↘ [90.69]	10.5 * [137.56]
Serie 4:	9.6 ↙ [38.24]	10.2 ↘ [54.87]	10.5 * [68.92]	10.3 ↘ [95.92]	9.7 ↓ [134.33]
Serie 5:	9.8 ↘ [13.95]	10.2 ↑ [55.41]	9.6 → [70.09]	9.7 ↓ [105.66]	10.8 * [116.99]
Serie 6:	10.3 ↘ [16.72]	8.7 ↙ [83.89]	10.7 * [94.45]	10.0 ↓ [98.97]	9.7 ↓ [131.42]

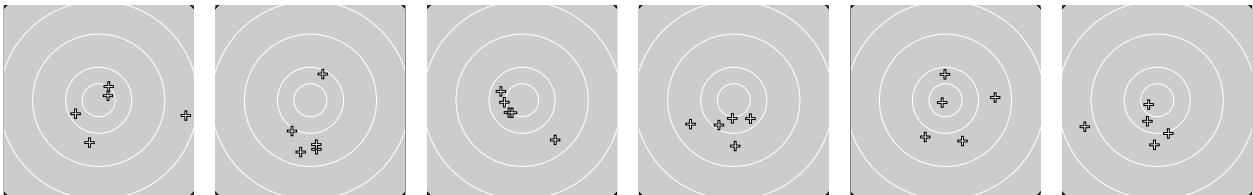

25m Pist. Auflage – Wertung Seniores I männl.

StartNr: 402

StandNr: 148

19. Juni 2022 15:47

Biegale, Thomas #212

3400 ABS Blomberg

Ergebnis: **278** 278 Serien: 48 47 47 45 45 46
 Zähler: 13 13 3 1 0 0 Innenezehner: 6

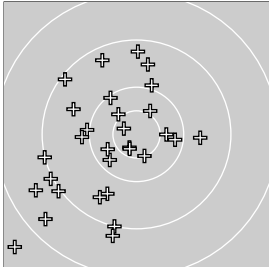

Auflage Wertung

Serie 1:	10.4 * [12.39]	9.3 ↑ [45.44]	10.7 * [59.54]	9.7 → [69.44]	10.2 ↙ [84.58]
Serie 2:	10.1 ↘ [13.32]	9.7 ↓ [25.57]	9.6 ↑ [41.83]	10.5 * [56.00]	9.1 ← [69.23]
Serie 3:	9.1 ↓ [15.70]	9.3 ↘ [48.76]	10.4 * [59.07]	10.0 ← [72.58]	9.0 ↙ [83.34]
Serie 4:	9.9 ← [10.40]	9.6 ↘ [42.80]	8.9 ↓ [60.19]	10.7 * [76.30]	9.5 ↙ [106.94]
Serie 5:	10.2 → [13.83]	7.5 ↘ [103.00]	10.0 ↑ [113.34]	8.6 ↙ [121.43]	10.3 ↙ [130.44]
Serie 6:	10.4 → [13.65]	10.6 * [29.28]	8.4 ↙ [44.84]	9.2 ↘ [60.14]	9.0 ↙ [72.87]



25m Pist. Auflage – Wertung Senioren III männl.

StartNr: 408

StandNr: 142

19. Juni 2022 15:48

Büscher, Michael #165

3100 SGes Heepen e.V. / SGes Heepen e.V.

Ergebnis: **273** 273 Serien: 45 44 45 47 47 45
 Zähler: 10 13 7 0 0 0 Innenzehner: 3

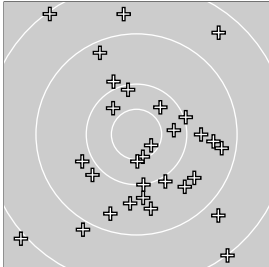

Auflage Wertung

Serie 1:	9.9 ↙ [14.60]	8.1 ↘ [29.78]	9.3 ↖ [47.30]	10.5 * [66.38]	9.7 ↓ [83.86]
Serie 2:	8.7 ↑ [9.54]	10.1 ↑ [31.61]	8.5 ↗ [58.76]	10.0 → [77.05]	8.1 ↘ [94.49]
Serie 3:	10.3 → [8.28]	9.9 ↙ [29.36]	9.5 → [48.60]	9.6 ↘ [66.88]	8.8 ↘ [86.91]
Serie 4:	10.3 ↘ [19.34]	9.8 → [32.15]	9.3 → [50.97]	9.6 ↘ [74.38]	10.6 * [98.89]
Serie 5:	9.9 ↖ [10.15]	10.0 ↓ [23.35]	10.5 * [41.95]	9.6 ↓ [62.90]	9.4 ↙ [81.86]
Serie 6:	9.8 ↓ [27.70]	10.0 ↘ [42.52]	8.9 ↙ [59.83]	10.3 ↗ [76.44]	8.0 ↗ [96.12]



25m Pist. Auflage – Wertung Senioren III männl.

StartNr: 409

StandNr: 143

4. August 2006 8:27

Fehring, Klaus-Werner #166

3100 SGes Heepen e.V. / SGes Heepen e.V.

Ergebnis: **271** 271 Serien: 48 45 41 46 44 47
 Zähler: 11 11 6 2 0 0 Innenzehner: 4

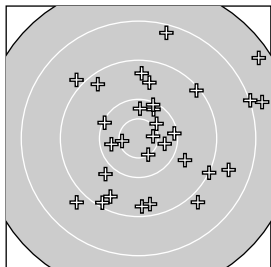

Auflage Wertung

Serie 1:	10.4 * [-1537579.67]	7.5 * [-1537569.95]	9.3 ↘ [-1537563.14]	9.4 ↓ [-1537557.25]	10.2 ↑ [-1537548.35]
Serie 2:	7.4 ↗ [-1537577.89]	9.6 ↑ [-1537565.79]	9.4 ↑ [-1537557.54]	10.3 ↑ [-1537545.11]	10.3 → [-1537517.97]
Serie 3:	7.8 → [-1537570.48]	10.0 → [-1537561.23]	9.2 ✓ [-1537551.87]	9.8 ↙ [-1537543.20]	10.8 ↙ [-1537534.29]
Serie 4:	8.6 → [-1537580.96]	10.1 ↑ [-1537572.30]	10.6 * [-1537563.60]	10.1 → [-1537554.44]	9.3 ↑ [-1537532.56]
Serie 5:	9.4 ↓ [-1537569.32]	9.8 → [-1537563.92]	9.1 → [-1537555.49]	9.8 ↘ [-1537545.96]	10.3 ↓ [-1537534.75]
Serie 6:	10.6 * [-1537592.05]	9.9 ↘ [-1537569.07]	10.3 ← [-1537561.13]	10.1 ↘ [-1537555.08]	9.1 ↗ [-1537536.54]

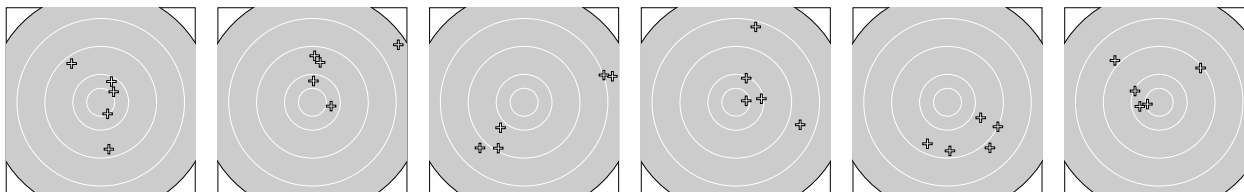

25m Pist. Auflage – Wertung Senioren IV männl.

StartNr: 434

StandNr: 141

19. Juni 2022 15:47

Dönnecke, Andreas #170

3100 SGes Heepen e.V. / SGes Heepen e.V.

Ergebnis: **276** 276 Serien: 45 48 48 46 42 47
 Zähler: 11 15 3 1 0 0 Innenzehner: 6

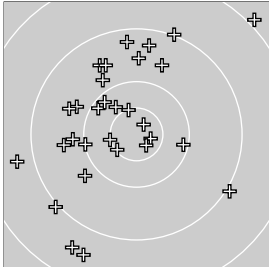

Auflage Wertung

Serie 1:	9.0 ↘ [7.39]	9.0 ↗ [24.74]	9.6 ↘ [39.21]	10.5 * [51.31]	8.6 ↙ [63.43]
Serie 2:	10.2 ↘ [16.17]	10.1 ← [34.55]	9.9 ← [43.75]	10.7 * [60.49]	9.7 ↗ [75.23]
Serie 3:	9.8 ↗ [14.32]	9.8 ↘ [32.10]	10.5 * [56.60]	10.7 * [67.42]	10.1 → [77.91]
Serie 4:	9.4 ↗ [14.95]	10.4 ↘ [36.41]	9.9 ↘ [51.58]	9.7 ← [65.00]	9.0 ↗ [82.12]
Serie 5:	7.9 ↗ [8.17]	9.6 ↘ [27.10]	10.2 ↘ [38.55]	8.6 ↙ [48.98]	8.7 ← [60.11]
Serie 6:	9.6 ↗ [4.35]	9.3 ↗ [24.99]	10.7 * [42.46]	9.7 ↘ [55.84]	10.5 * [69.10]



25m Pist. Auflage – Wertung Senioren IV männl.

StartNr: 435

StandNr: 144

19. Juni 2022 15:47

Beersiek, Bernhard #169

3100 SGes Heepen e.V.

Ergebnis: **232** 232 Serien: 38 44 42 35 37 36
 Zähler: 5 5 9 6 2 1 Innenzehner: 1

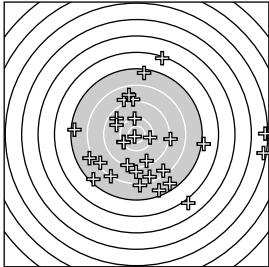

Auflage Wertung

Serie 1:	9.1 ↘ [23.08]	6.2 ↑ [31.58]	8.4 ↘ [37.33]	10.1 ↙ [43.20]	5.8 ↘ [50.09]
Serie 2:	9.5 ↘ [14.69]	7.4 ↘ [30.41]	9.3 ↘ [35.85]	9.0 → [45.77]	10.1 ↑ [51.56]
Serie 3:	10.2 → [25.59]	9.7 ↘ [31.60]	8.8 ↑ [38.96]	8.3 ↙ [45.46]	7.4 ↘ [56.62]
Serie 4:	7.3 ← [13.88]	7.9 ↙ [27.68]	7.3 ↙ [35.17]	6.9 → [45.33]	8.8 ↓ [55.37]
Serie 5:	8.9 ↑ [11.03]	3.2 → [19.79]	8.0 ↓ [32.84]	10.1 ↙ [42.73]	8.3 ↘ [50.71]
Serie 6:	7.3 ↑ [11.42]	10.8 * [17.94]	8.6 ↑ [30.52]	8.1 ↙ [47.77]	3.2 → [62.30]

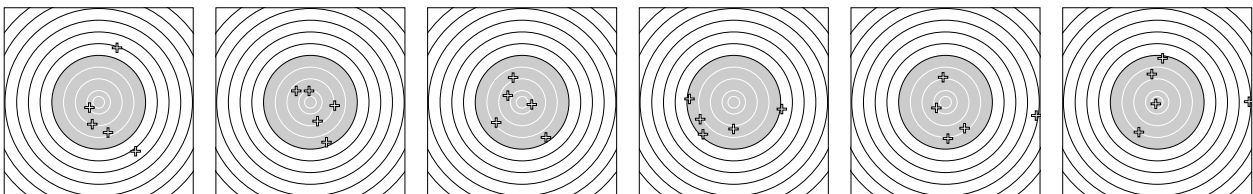

25m Pist. Auflage – Wertung Seniores I männl.

StartNr: 379

StandNr: 146

19. Juni 2022 16:42

Jürgens, Petra #221 3400 PoISV Lippe–Detmold e.V. / PoISV Lippe–Detmold e.V.

Ergebnis: **276** 276 Serien: 46 47 45 46 47 45
 Zähler: 10 16 4 0 0 0 Innenezehner: 4

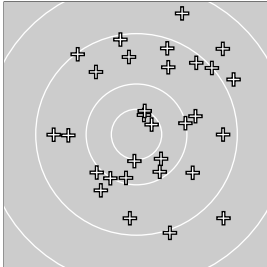

Auflage Wertung

Serie 1:	9.7 ← [14.39]	10.6 * [42.52]	9.8 → [68.61]	9.7 ↘ [114.90]	9.6 ↖ [132.87]
Serie 2:	10.2 ↘ [20.75]	9.2 ↑ [42.36]	10.3 ↘ [66.15]	9.3 → [92.45]	9.1 ↗ [124.65]
Serie 3:	9.5 ↑ [31.86]	8.5 ↑ [47.63]	10.2 ↓ [68.31]	9.6 ↑ [88.15]	9.0 ↘ [109.84]
Serie 4:	9.1 ↘ [17.42]	10.0 ↗ [34.28]	9.4 ← [58.39]	9.4 ↓ [102.74]	9.2 ↑ [119.46]
Serie 5:	9.7 ↗ [14.68]	10.0 ↘ [33.35]	10.5 * [53.65]	8.7 ↗ [74.26]	10.6 * [105.79]
Serie 6:	10.5 * [16.68]	9.2 ↗ [34.95]	8.7 ↘ [61.01]	10.1 → [79.69]	8.8 ↗ [101.19]

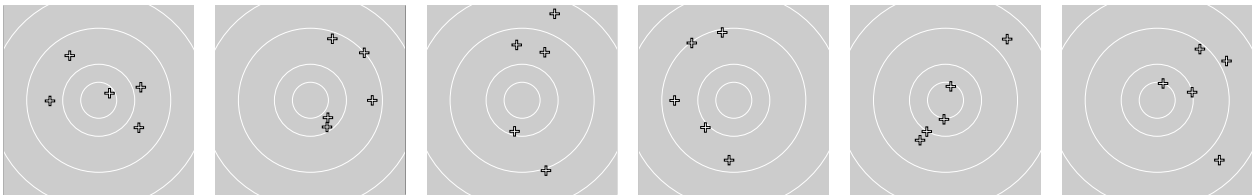

25m Pist. Auflage – Wertung Seniores I männl.

StartNr: 380

StandNr: 144

19. Juni 2022 16:42

Klöppling, Birgit #219 3400 PoISV Lippe–Detmold e.V. / PoISV Lippe–Detmold e.V.

Ergebnis: **271** 271 Serien: 44 46 45 44 49 43
 Zähler: 8 16 5 1 0 0 Innenzehner: 5

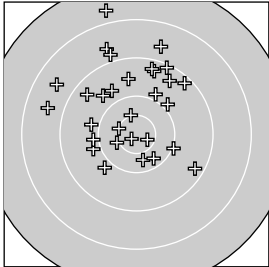

Auflage Wertung

Serie 1:	7.7 ↑ [6.87]	9.3 ↑ [46.29]	10.7 * [61.60]	9.9 ↙ [80.02]	9.9 ↗ [108.77]
Serie 2:	8.6 ↘ [11.33]	9.8 ↘ [36.27]	10.5 * [66.82]	10.3 ↓ [88.71]	9.3 ↘ [111.49]
Serie 3:	9.4 ↗ [12.73]	9.9 ← [31.85]	9.4 ↘ [80.50]	9.2 ↗ [99.79]	9.1 ↑ [117.11]
Serie 4:	8.7 ↑ [7.00]	8.9 ↑ [31.79]	10.5 * [53.50]	9.6 ↑ [74.34]	9.3 ↑ [94.75]
Serie 5:	9.9 ← [8.20]	10.5 * [25.80]	10.3 ↓ [47.71]	10.0 ↘ [69.83]	10.8 * [89.32]
Serie 6:	8.6 ↘ [10.43]	9.9 ← [31.40]	9.7 ↘ [53.76]	9.9 ↑ [81.40]	8.7 ↑ [103.27]

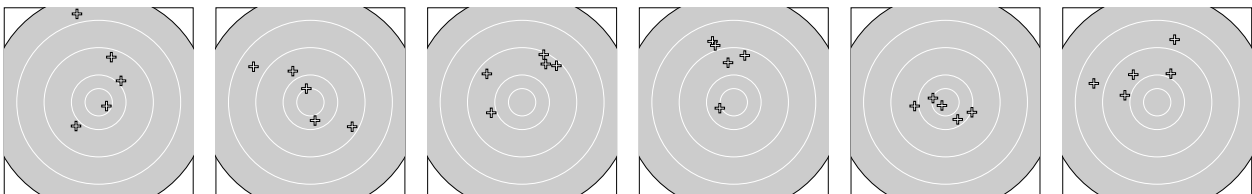

25m Pist. Auflage – Wertung Seniores I männl.

StartNr: 381

StandNr: 143

4. August 2006 9:22

Vogt, Roswitha #218 3400 PoISV Lippe–Detmold e.V. / PoISV Lippe–Detmold e.V.

Ergebnis: **261** 261 Serien: 41 46 45 48 41 40
Zähler: 7 13 6 2 2 0 Innenzehner: 2

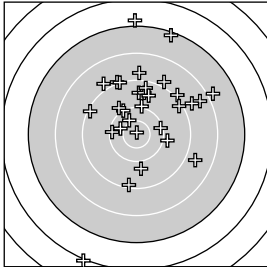

Auflage Wertung

Serie 1:	8.8 ↑	[-1537591.6]	10.0 ↘	[-1537569.2]	8.8 ↘	[-1537547.1]	9.0 ↘	[-1537527.2]	8.8 ↑	[-1537502.95]
Serie 2:	10.4 ↖	[-1537583.7]	9.5 ↑	[-1537563.5]	9.1 ↖	[-1537539.7]	9.8 ↓	[-1537518.7]	9.9 ↘	[-1537494.36]
Serie 3:	8.9 ↗	[-1537583.3]	9.0 ↗	[-1537560.9]	9.0 ↗	[-1537536.4]	9.5 ↑	[-1537516.4]	9.1 ↖	[-1537495.35]
Serie 4:	10.0 ↑	[-1537587.3]	9.3 ↑	[-1537566.8]	9.9 *	[-1537545.8]	9.2 ↓	[-1537524.3]	9.4 *	[-1537501.72]
Serie 5:	8.7 ↘	[-1537587.9]	9.9 ↗	[-1537565.0]	9.2 ↗	[-1537542.5]	9.4 ↗	[-1537525.7]	9.6 ↑	[-1537506.79]
Serie 6:	6.0 ↙	[-1537587.7]	7.2 ↑	[-1537570.9]	9.9 ↗	[-1537553.4]	9.7 ↗	[-1537530.6]	9.1 ↗	[-1537513.19]

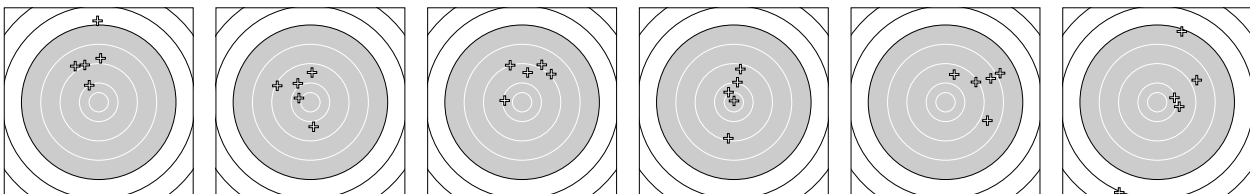

25m Pist. Auflage – Wertung Seniore I männl.

StartNr: 383

StandNr: 142

19. Juni 2022 16:42

Neese, Markus #217 3400 PoISV Lippe–Detmold e.V. / PoISV Lippe–Detmold e.V.

Ergebnis: **265** 265 Serien: 45 45 43 46 43 43
 Zähler: 7 13 8 2 0 0 Innenzehner: 2

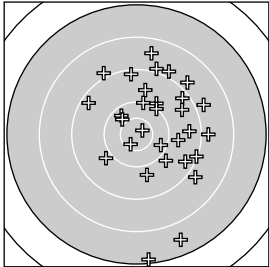

Auflage Wertung

Serie 1:	10.3 ↘ [12.74]	8.8 → [32.99]	8.8 ↘ [56.77]	9.4 → [81.34]	10.6 * [110.69]
Serie 2:	8.5 ↑ [15.55]	9.3 ↘ [39.43]	10.2 ↘ [63.01]	9.7 ↑ [86.37]	9.8 ↘ [108.66]
Serie 3:	7.5 ↘ [21.09]	9.9 ↗ [44.42]	9.8 ↓ [73.23]	9.1 ↘ [100.64]	9.3 ↘ [124.77]
Serie 4:	9.8 → [16.85]	8.9 ↗ [43.28]	9.9 ↗ [74.93]	10.1 ↑ [101.23]	10.1 ↗ [121.08]
Serie 5:	9.3 ↗ [17.14]	8.9 ↑ [44.04]	10.4 ↘ [66.00]	7.2 ↓ [90.16]	9.2 ↑ [112.82]
Serie 6:	8.8 ↗ [15.67]	8.8 → [40.01]	9.5 ↗ [63.43]	8.9 ↘ [87.06]	10.8 * [104.34]

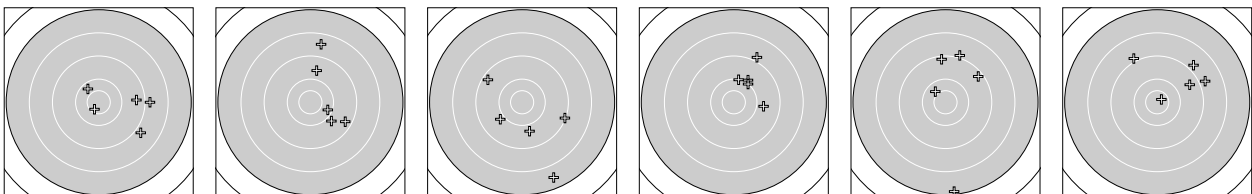

25m Pist. Auflage – Wertung Seniores I männl.

StartNr: 384

StandNr: 145

19. Juni 2022 16:42

Schirrmann, Gudrun #2200 PolSV Lippe–Detmold e.V. / PolSV Lippe–Detmold e.V.

Ergebnis: **261** 261 Serien: 40 47 42 48 46 38
 Zähler: 9 7 12 1 0 1 Innenzehner: 1

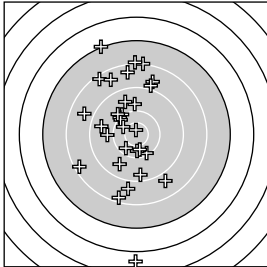

Auflage Wertung

Serie 1:	8.2 ↘ [17.80]	7.0 ↘ [36.90]	8.7 ↘ [49.78]	9.8 ← [54.65]	8.3 ↙ [68.96]
Serie 2:	10.0 ↘ [19.02]	10.0 ↘ [28.90]	8.7 ↓ [36.50]	10.1 ↘ [52.64]	9.5 ← [62.43]
Serie 3:	8.3 ↓ [19.77]	8.7 ↑ [39.08]	9.6 ↗ [43.85]	9.8 ↑ [56.21]	8.4 ↑ [69.07]
Serie 4:	8.9 ↑ [15.74]	10.1 ↘ [28.86]	10.8 * [35.84]	10.4 ↘ [47.77]	10.3 ↗ [57.39]
Serie 5:	9.3 ↓ [19.12]	10.3 ↓ [29.99]	10.4 ↓ [45.78]	9.6 ↗ [52.19]	8.5 ↘ [66.64]
Serie 6:	8.7 ↘ [20.51]	5.6 ↓ [30.02]	8.0 ↑ [49.39]	9.9 ↘ [54.97]	8.0 ↑ [76.31]

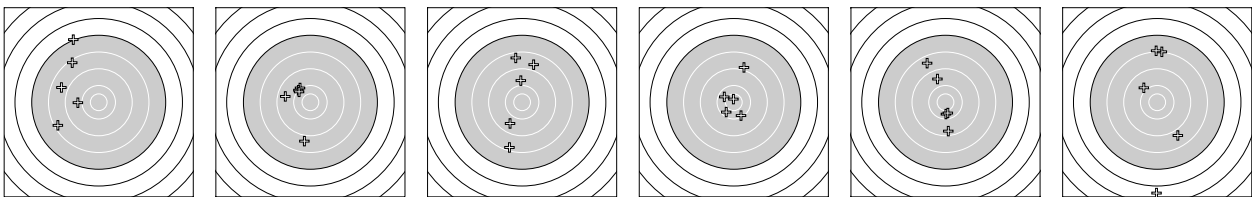

25m Pist. Auflage – Wertung Seniorenl III männl.

StartNr: 411

StandNr: 147

19. Juni 2022 16:42

Klöppling, Rolf #222 3400 PoISV Lippe–Detmold e.V. / PoISV Lippe–Detmold e.V.

Ergebnis: **277** 277 Serien: 43 46 46 48 48 46
 Zähler: 13 11 6 0 0 0 Innenezehner: 8

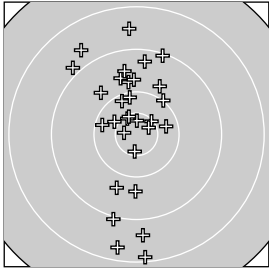

Auflage Wertung

Serie 1:	8.2 ↓ [13.91]	8.7 ↓ [41.16]	9.0 ↓ [75.40]	10.7 * [101.29]	8.7 ↖ [119.19]
Serie 2:	8.4 ↓ [21.25]	10.7 * [42.82]	9.7 ↖ [66.44]	9.5 ↑ [88.16]	10.5 * [108.62]
Serie 3:	9.8 ↗ [14.12]	9.1 ↗ [34.43]	10.6 * [63.50]	8.6 ↑ [83.70]	10.2 ↖ [102.93]
Serie 4:	10.3 → [17.76]	9.8 ↑ [39.91]	10.6 * [61.39]	9.8 ↖ [83.81]	10.5 * [107.03]
Serie 5:	10.7 * [17.24]	10.0 ↗ [37.25]	10.2 ↖ [58.36]	10.2 ↑ [80.80]	8.9 ↖ [101.49]
Serie 6:	9.7 ↓ [49.07]	10.4 * [73.42]	9.7 ↓ [90.65]	9.8 ↑ [105.04]	9.3 ↑ [119.53]

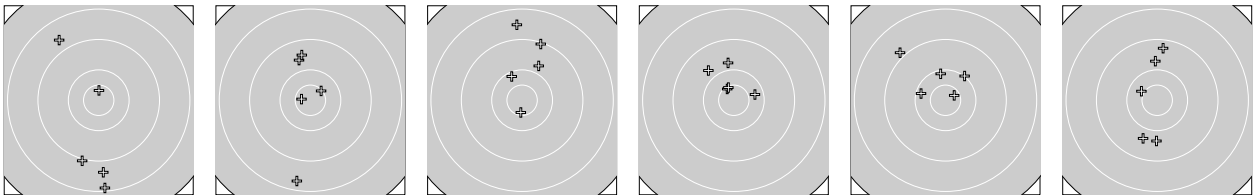

25m Pist. Auflage – Wertung Senioren III männl.

StartNr: 412

StandNr: 148

19. Juni 2022 16:46

Pfeffer, Michael #223 3400 PoISV Lippe–Detmold e.V. / PoISV Lippe–Detmold e.V.

Ergebnis: **256** 256 Serien: 43 49 36 44 40 44
 Zähler: 7 13 6 3 0 0 Innenzehner: 2

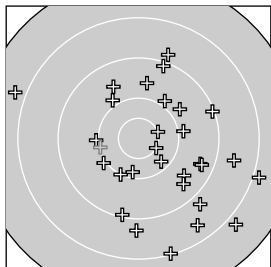

Auflage Wertung

Serie 1:	7.8 ↖ [16.15]	9.1 ↓ [39.92]	9.9 ↘ [63.16]	8.8 ↓ [89.85]	10.2 ↘ [111.89]
Serie 2:	10.5 * [14.73]	9.6 ↘ [36.01]	10.0 ← [54.06]	10.0 ↗ [72.62]	10.2 ↓ [93.11]
Serie 3:	10.0 ↗ [34.16]	9.7 ↑ [12.10]	10.1 ← [24.14]	9.8 ↗ [46.78]	8.9 ↑ [81.66]
Serie 4:	9.9 ↗ [10.18]	9.1 → [24.05] ^{REP}	9.4 ↘ [38.73] ^{REP}	9.4 ↘ [53.27] ^{REP}	8.1 ↓ [69.39] ^{REP}
Serie 5:	7.9 ↘ [4.80]	8.6 → [16.71]	7.8 ↘ [31.33]	9.6 ↘ [41.32]	9.5 ↘ [50.82]
Serie 6:	8.8 ↘ [12.45]	9.2 ↑ [23.49]	10.5 * [34.61]	8.5 ↘ [44.45]	9.9 → [58.25]

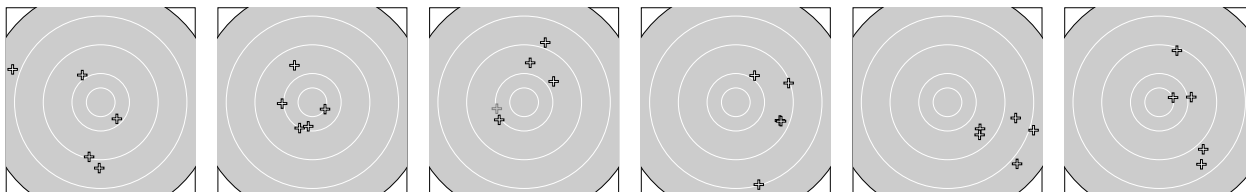

REP

– Treffer stammt aus einer Wiederholungsserie oder Serienauffüllung



25m Pist. Auflage – Wertung Senioren III männl.

StartNr: 413

StandNr: 149

19. Juni 2022 16:42

Vogt, Dieter #224

3400 PoISV Lippe–Detmold e.V. / PoISV Lippe–Detmold e.V.

Ergebnis: **267** 267 Serien: 44 43 46 48 42 44
 Zähler: 11 10 5 3 1 0 Innenzehner: 3

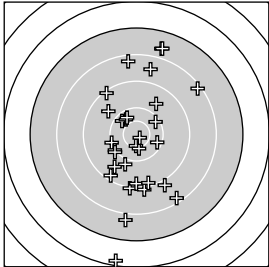

Auflage Wertung

Serie 1:	8.2 ↘ [12.31]	9.7 ↘ [27.66]	8.6 ↑ [38.38]	9.7 ↗ [49.90]	10.3 ↖ [116.58]
Serie 2:	7.7 ↑ [8.94]	9.0 ↓ [22.72]	8.2 ↗ [45.90]	9.2 ↘ [67.44]	10.1 ← [86.63]
Serie 3:	9.1 ↖ [11.34]	10.2 ↘ [34.52]	9.2 ↓ [57.48]	9.9 ↘ [82.51]	9.0 ↓ [103.92]
Serie 4:	9.2 ↓ [13.12]	10.0 ↗ [23.99]	9.6 ↘ [39.63]	10.3 ↖ [55.37]	10.6 * [58.47]
Serie 5:	7.7 ↑ [12.49]	10.5 * [27.76]	10.2 ↗ [52.19]	8.9 ↘ [69.96]	7.8 ↓ [90.76]
Serie 6:	8.3 ↑ [16.11]	6.2 ↓ [33.92]	10.3 ↖ [64.07]	10.0 ↗ [81.73]	10.8 * [98.36]

